

Hans Hagen

context mkiv
metafun

For them

I owe much inspiration to both my parents. My mother Jannie constantly demonstrated me that computer graphics will never improve nature. She also converted one of my first METAPOST graphics into a patchwork that will remind me forever that handcraft is more vivid than computer artwork. My father Hein has spent a great deal of his life teaching math, and I'm sure he would have loved METAPOST. I inherited his love for books. I therefore dedicate this document to them.

Colofon

This manual is typeset with CONTEX_T MKIV. No special tricks are used and everything you see in here, is available for CONTEX_T users. The text is typeset in Palatino and Computer Modern Typewriter. We used L_UA_TE_X as T_EX processing engine. Since this document is meant to be printed in color, some examples will look sub-optimal when printed in black and white.

Graphics

The artist impression of one of Hasselts canals at page 218 is made by Johan Jonker. The CDROM production process graphic at page 215 is a scan of a graphic made by Hester de Weert.

Copyright

Hans Hagen, PRAGMA Advanced Document Engineering, Hasselt NL
copyright: 1999-2017 / version 4: March 31, 2017

Publisher

publisher: Boekplan, NL
isbn-ean: 978-94-90688-02-8
website: www.boekplan.nl

Info

internet: www.pragma-ade.com
support: ntg-context@ntg.nl
context: www.contextgarden.net

Introduction

This document is about METAPOST and T_EX. The former is a graphic programming language, the latter a typographic programming language. However, in this document we will not focus on real programming, but more on how we can interface between those two languages. We will do so by using CONTEX_T, a macro package written in T_EX, in which support for METAPOST is integrated in the core. The T_EX macros are integrated in CONTEX_T, and the METAPOST macros are bundled in METAFUN.

When Donald Knuth wrote his typographical programming language T_EX he was in need for fonts, especially mathematical fonts. So, as a side track, he started writing METAFONT, a graphical language. When you read between the lines in the METAFONT book and the source code, the name John Hobby is mentioned alongside complicated formulas. It will be no surprise then, that, since he was tightly involved in the development of METAFONT, after a few years his METAPOST showed up.

While its ancestor METAFONT was originally targeted at designing fonts, METAPOST is more oriented to drawing graphics as used in scientific publications. Since METAFONT produced bitmap output, some of its operators make use of this fact. METAPOST on the other hand produces POSTSCRIPT code, which means that it has some features not present in METAFONT and vice versa.

With METAFUN I will demonstrate that METAPOST can also be used, or misused, for less technical drawing purposes. We will see that METAPOST can fill in some gaps in T_EX, especially its lack of graphic capabilities. We will demonstrate that graphics can make a document more attractive, even if it is processed in a batch processing system like T_EX. Most of all, we will see that embedding METAPOST definitions in the T_EX source enables a smooth communication between both programs.

The best starting point for using METAPOST is the manual written by its author John Hobby. You can find this manual at every main T_EX repository. Also, a copy of the METAFONT book from Donald Knuth is worth every cent, if only because it will give you the feeling that many years of graphical fun lays ahead.

In this METAFUN manual we will demonstrate how you can embed graphics in a T_EX document, but we will also introduce most of the features of METAPOST. For this reason you will see a lot of METAPOST code. For sure there are better methods to solve problems, but I have tried to demonstrate different methods and techniques as much as possible.

I started using METAPOST long after I started using T_EX, and I never regret it. Although I like T_EX very much, I must admit that sometimes using METAPOST is even more fun. Therefore, before we start exploring both in depth, I want to thank their creators, Donald Knuth and John Hobby, for providing me these fabulous tools. Of course I also need to thank Hàn Thế Thành, for giving the T_EX community PDF_TE_X, as well as providing me the hooks I considered necessary for implementing some of the features presented here. In the meantime Taco Hoekwater has created the METAPOST library so that it can be an integral component of L^AT_EX. After that happened, the program was extended to deal with more than one number implementation: in addition to scaled integers we now can switch to floats and arbitrary precision decimal or binary calculations. I myself prototyped a simple but efficient LUA script interface. With Luigi Scarso, who is now the maintainer of METAPOST, we keep improving the system, so who knows what will show up next.

I also want to thank David Arnold and Ton Otten for their fast proofreading, for providing me useful input, and for testing the examples. Without David's patience and help, this document would be far from perfect English and less complete. Without Ton's help, many small typos would have gone unnoticed.

In the second version of this manual the content was been adapted to `CONTEXT` MKIV that uses `LUATEX` and the built in `METAPOST` library. In the meantime some `LUA` has been brought into the game, not only to help construct graphics, but also as a communication channel. In the process some extra features have been added and some interfacing has been upgraded. The third version of this document deals with that too. It makes no sense to maintain compatibility with `CONTEXT` MKII, but many examples can be used there as well. In the meantime most `CONTEXT` users have switched to MKIV, so this is no real issue. In the fourth update some new features are presented and the discussion of obsolete ones have been removed.

The fifth update describes the `MPIV` version of `METAFUN` which brings some more and improved functionality. Some examples are inspired from questions by users and examples that Alan Braslau, Luigi Scarso and I made when testing new features and macros. Some examples can be rewritten in a more efficient way but are kept as they are. Therefore this manual presents different ways to solve problems. Hopefully this is not too confusing. Numerous examples can be found in the other manuals and test suite.

Hans Hagen
Hasselt NL
March 2017

Content

Conventions	5	3 Embedded graphics	117
1 Welcome to MetaPost	7	3.1 Getting started	117
1.1 Paths	7	3.2 External graphics	117
1.2 Transformations	10	3.3 Integrated graphics	118
1.3 Constructing paths	14	3.4 Using METAFUN but not CONTEX	122
1.4 Angles	22	3.5 Graphic buffers	123
1.5 Drawing pictures	23	3.6 Communicating color	124
1.6 Variables	26	3.7 One page graphics	127
1.7 Conditions	28	3.8 Managing resources	128
1.8 Loops	28	3.9 Instances	129
1.9 Macros	30	4 Enhancing the layout	135
1.10 Arguments	32	4.1 Overlays	135
1.11 Pens	33	4.2 Overlay variables	137
1.12 Joining lines	37	4.3 Stacking overlays	137
1.13 Colors	37	4.4 Foregrounds	137
1.14 Dashes	39	4.5 Typesetting graphics	139
1.15 Text	39	4.6 Graphics and macros	141
1.16 Linear equations	40	5 Positional graphics	151
1.17 Clipping	47	5.1 The status quo	151
1.18 Some extensions	49	5.2 The concept	151
1.19 Cutting and pasting	57	5.3 A more detailed view	153
1.20 Current picture	60	5.4 Anchors and layers	156
2 A few more details	63	5.5 More layers	158
2.1 Making graphics	63	5.6 Complex text in graphics	164
2.2 Bounding boxes	64	6 Page backgrounds	167
2.3 Units	69	6.1 The basic layout	167
2.4 Scaling and shifting	71	6.2 Setting up backgrounds	171
2.5 Curve construction	73	6.3 Multiple overlays	174
2.6 Inflection, tension and curl	79	6.4 Crossing borders	175
2.7 Transformations	88	6.5 Bleeding	182
2.8 Only this far	91	7 Shapes, symbols and buttons	185
2.9 Directions	97	7.1 Interfacing to T _E X	185
2.10 Analyzing pictures	98	7.2 Random graphics	186
2.11 Filling	103	7.3 Graphic variables	189
2.12 Pitfalls	106	7.4 Shape libraries	190
2.13 T _E X versus MetaPost	108		
2.14 Internals and Interims	109		
2.15 Named colors	110		
2.16 Formatted text	110		
2.17 Lists (aka suffixed variables)	112		
2.18 Segmented paths	114		

7.5	Symbol collections	191	13.5	Fool yourself	308
8	Special effects	195	13.6	Growing graphics	312
8.1	Spot colors	195	13.7	Simple Logos	320
8.2	Transparency	195	13.8	Music sheets	324
8.3	Shading	200	13.9	The euro symbol	326
8.4	Clipping	210	13.10	Killing time	329
8.5	Including graphics	215	13.11	Selective randomization	332
8.6	Changing colors	217	13.12	Snapping	333
8.7	Outline fonts	221	13.13	Arrowheads	335
8.8	Transparency groups	227	13.14	Teaser	336
8.9	Decorating	228	13.15	Lists	336
8.10	Properties	231	13.16	Table cells	340
9	Functions	233	14	METAFUN macros	343
9.1	Overview	233	15	Lua	345
9.2	Grids	234	15.1	Introduction	345
9.3	Drawing functions	236	15.2	The basics	345
10	Typesetting in METAPOST	245	15.3	Helpers	346
10.1	The process	245	15.4	Access to variables	351
10.2	Environments	245	15.5	The library	352
10.3	Labels	246	15.6	CONTEX helpes	352
10.4	T _E X text	247	15.7	Paths	353
10.5	Talking to T _E X	256	15.8	Passing variables	357
10.6	Libraries	266	16	Conventions	361
11	Debugging	273	16.1	Suffixes	361
11.1	Showing paths	273	A	METAPOST syntax	363
11.2	Comments	277	B	This document	377
11.3	Pens	278	C	Reference	379
12	Defining styles	281	C.1	Paths	379
12.1	Adaptive buttons	281	C.2	Transformations	395
13	A few applications	289	C.3	Points	405
13.1	Simple drawings	289	C.4	Colors	407
13.2	Free labels	292	C.5	Attributes	410
13.3	Marking angles	297	C.6	Text	415
13.4	Color circles	302	C.7	Control	417
			C.8	Graphics	418
			Index		421

Conventions

When reading this manual, you may be tempted to test the examples shown. This can be done in several ways. You can make a file and process that file by METAPOST. Such a file looks like:

```
beginfig(1) ;
  fill fullcircle scaled 5cm withcolor red ; % a graphic
endfig ;

end .
```

Don't forget the semi-colons that end the statements. If the file is saved as `yourfile.mp`, then the file can be processed. Before we process this file, we first need to load some basic METAPOST definitions, because the built in repertoire of commands is rather limited. Such a set is called a format. The standard format is called `metapost` but we will use a more extensive set of macros `metafun`. In the past such a set was converted into a `mem` file and running the above file was done with:

```
mpost --mem=metafun.mem yourfile
```

However, this is no longer the case and macros need to be loaded at startup as follows:

```
mpost --ini metafun.mpii yourfile.mp
```

Watch the suffix `mpii`: this refers to the stand alone, the one that doesn't rely on L^AT_EX.

After the run the results are available in `yourfile.1` and can be viewed with `GHOSTSCRIPT`. You don't need to close the file so reprocessing is very convenient.

Because we will go beyond standard METAPOST, we will use the `mpiv` files. These work with the library which in turn means that we will run from within `CONTEXT`. This has the advantage that we also have advanced font support at our hands. In that case, a simple file looks like:

```
\starttext
\startMPPage
  fill fullcircle scaled 5cm withcolor red ;
\stopMPPage
\startMPPage
  fill unitsquare scaled 5cm withcolor red ;
\stopMPPage
\stoptext
```

If the file is saved as `yourfile.tex`, then you can produce a PDF file with:¹

```
context yourfile
```

The previous call will use L^AT_EX and `CONTEXT MKIV` to produce a file with two pages using the built in METAPOST library with `METAFUN`. When you use this route you will automatically get the integrated text support shown in this manual, including `OPENTYPE` support. If one page is enough, you can also say:

¹ In fact, you could also process the METAPOST file directly because the `context` script will recognize it as such and wrap it into a page.

```
\startMPpage  
fill fullcircle scaled 5cm withcolor red ;  
\stopMPpage
```

So when you have a running `CONTEXT` on your system you don't need to bother about installing `METAPOST` and running `METAFUN`.

We will use lots of color. Don't worry if your red is not our red, or your yellow does not match ours. We've made color definitions to match the overall design of this document, but you should feel free to use any color of choice in the upcoming examples.

By default, `CONTEXT` has turned its color mechanism on. If you don't want your graphics to have color, you should say:

```
\setupcolors[state=stop]
```

but in today's documents color is so normal that you will probably never do that. Because `METAFUN` hooks into the `CONTEXT` color mechanism, you can also use its color space and conversion related features.

You need to keep in mind that just like `CONTEXT MKII` is frozen, the `mpii` macros are also not extended. From now on we assume that you use `CONTEXT MKIV` which exclusively uses `mpiv` macros.

Even if you want to use `METAFUN` but not `CONTEXT`, you can still best use the mentioned page method as it will give you decent text processing. You need to know (and use) only a few `CONTEXT` commands then.

1 Welcome to MetaPost

In this chapter, we will introduce the most important METAPOST concepts as well as demonstrate some drawing primitives and operators. This chapter does not replace the METAFONT book or METAPOST manual, both of which provide a lot of explanations, examples, and (dirty) tricks.

As its title says, the METAFONT book by Donald. E. Knuth is about fonts. Nevertheless, buying a copy is worth the money, because as a METAPOST user you can benefit from the excellent chapters about curves, algebraic expressions, and (linear) equations. The following sections are incomplete in many aspects. More details on how to define your own macros can be found in both the METAFONT book and METAPOST manual, but you will probably only appreciate the nasty details if you have written a few simple figures yourself. This chapter will give you a start.

A whole section is dedicated to the basic extensions to METAPOST as provided by METAFUN. Most of them are meant to make defining graphics like those shown in this document more convenient.

Many of the concepts introduced here will be discussed in more detail in later chapters. So, you may consider this chapter to be an appetizer for the following chapters. If you want to get started quickly, you can safely skip this chapter now.

1.1 Paths

Paths are the building blocks of METAPOST graphics. In its simplest form, a path is a single point.

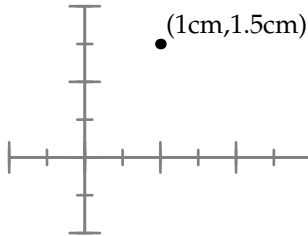

Such a point is identified by two numbers, which represent the horizontal and vertical position, often referred to as x and y , or (x,y) . Because there are two numbers involved, in METAPOST this point is called a pair. Its related datatype is therefore `pair`. The following statements assigns the point we showed previously to a pair variable.

```
pair somepoint ; somepoint := (1cm,1.5cm) ;
```

A pair can be used to identify a point in the two dimensional coordinate space, but it can also be used to denote a vector (being a direction or displacement). For instance, $(0,1)$ means 'go up'. Looking through math glasses, you may consider them vectors, and if you know how to deal with them, METAPOST may be your friend, since it knows how to manipulate them.

You can connect points and the result is called a path. A path is a straight or bent line, and is not necessarily a smooth curve. An example of a simple rectangular path is:²

² In the next examples we use the debugging features discussed in chapter 11 to visualize the points, paths and bounding boxes.

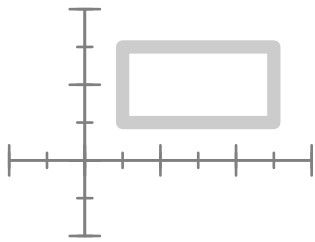

This path is constructed out of four points:

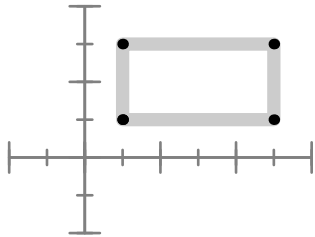

Such a path has both a beginning and end and runs in a certain direction:

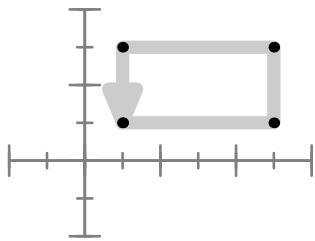

A path can be open or closed. The previous path is an example of a closed path. An open path looks like this:

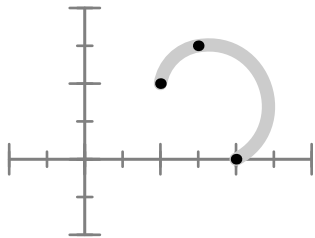

When we close this path—and in a moment we will see how to do this—the path looks like:

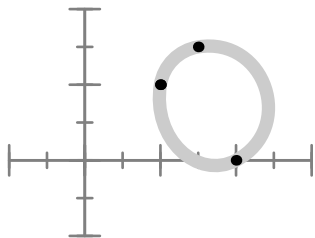

The open path is defined as:

$$(1\text{cm}, 1\text{cm}) \dots (1.5\text{cm}, 1.5\text{cm}) \dots (2\text{cm}, 0\text{cm})$$

The 'double period' connector `..` tells METAPOST that we want to connect the lines by a smooth curve. If you want to connect points with straight line segments, you should use `--`.

Closing the path is done by connecting the first and last point, using the `cycle` command.

```
(1cm,1cm)..(1.5cm,1.5cm)..(2cm,0cm)..cycle
```

Feel free to use `..` or `--` at any point in your path.

```
(1cm,1cm)--(1.5cm,1.5cm)..(2cm,0cm)..cycle
```

This path, when drawn, looks like this:

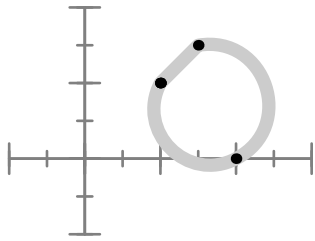

As you can see in some of the previous examples, METAPOST is capable of drawing a smooth curve through the three points that make up the path. We will now examine how this is done.

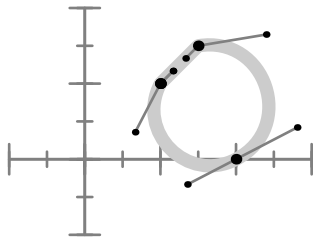

The six small points are the so called control points. These points pull their parent point in a certain direction. The further away such a point is, the stronger the pull.

Each point has at most two control points. As you can see in the following graphic, the endpoints of a non closed curve have only one control point.

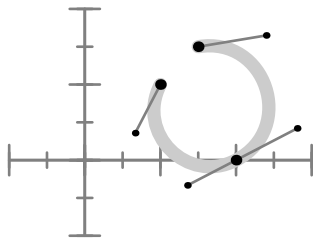

This time we used the path:

```
(1.5cm,1.5cm)..(2cm,0cm)..(1cm,1cm)
```

When you connect points by a smooth curve, METAPOST will calculate the control points itself, unless you specify one or more of them.

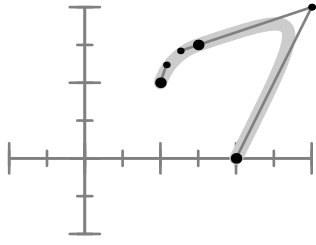

This path is specified as:

```
(1cm,1cm)..(1.5cm,1.5cm)..controls (3cm,2cm)..(2cm,0cm)
```

In this path, the second and third point share a control point. Watch how the curve is pulled in that direction. It is possible to pull a bit less by choosing a different control point:

```
(1cm,1cm)..(1.5cm,1.5cm)..controls (2.75cm,1.25cm)..(2cm,0cm)
```

Now we get:

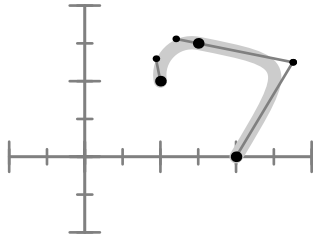

We can also specify a different control point for each connecting segment.

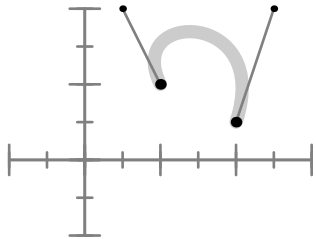

This path is defined as:

```
(1cm,1cm)..controls (.5cm,2cm) and (2.5cm,2cm)..(2cm,.5cm)
```

1.2 Transformations

We can store a path in a path variable. Before we can use such a variable, we have to allocate its memory slot with path.

```
path p ; p := (1cm,1cm)..(1.5cm,2cm)..(2cm,0cm) ;
```

Although we can manipulate any path in the same way, using a variable saves us the effort to key in a path more than once.

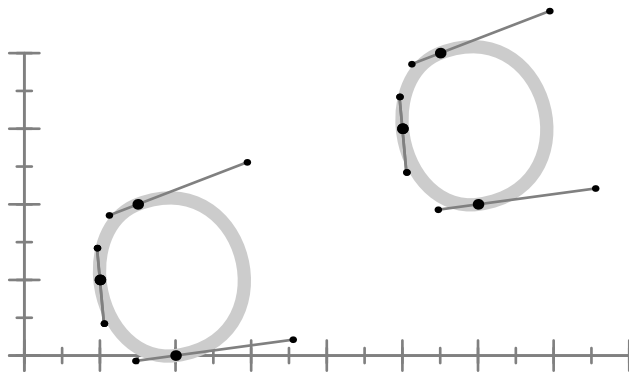

In this graphic, the path stored in `p` is drawn twice, once in its displaced form. The displacement is defined as:

```
p shifted (4cm,2cm)
```

In a similar fashion you can rotate a path. You can even combine shifts and rotations. First we rotate the path 15 degrees counter-clockwise around the origin.

```
p rotated 15
```

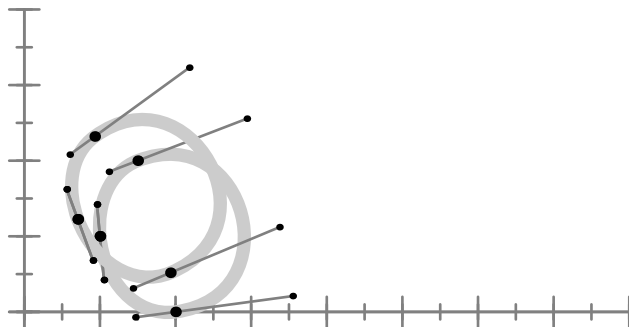

This rotation becomes more visible when we also shift the path to the right by saying:

```
rotated 15 shifted (4cm,0cm)
```

Now we get:

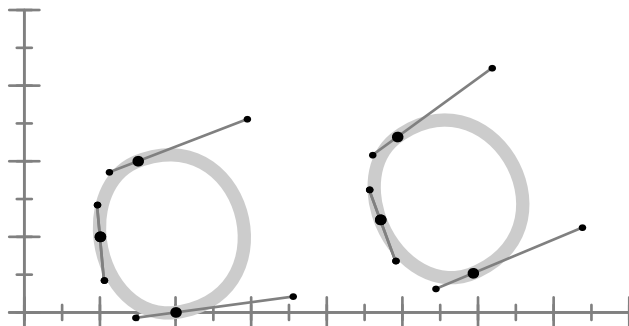

Note that `rotated 15` is equivalent to `p rotatedaround (origin, 15)`.

It may make more sense to rotate the shape around its center. This can easily be achieved with the `rotatedaround` command. Again, we move the path to the right afterwards.

```
p rotatedaround(center p, 15) shifted (4cm,0cm)
```

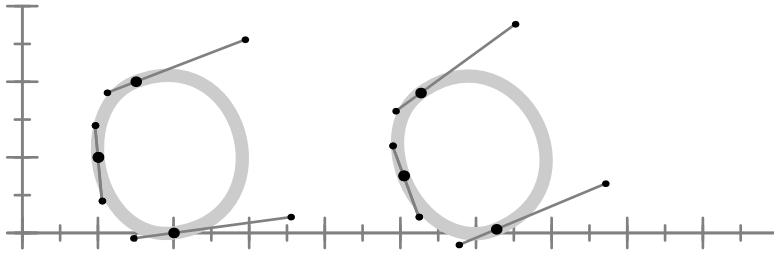

Yet another transformation is slanting. Just like characters can be upright or slanted, a graphic can be:

```
p slanted 1.5 shifted (4cm,0cm)
```

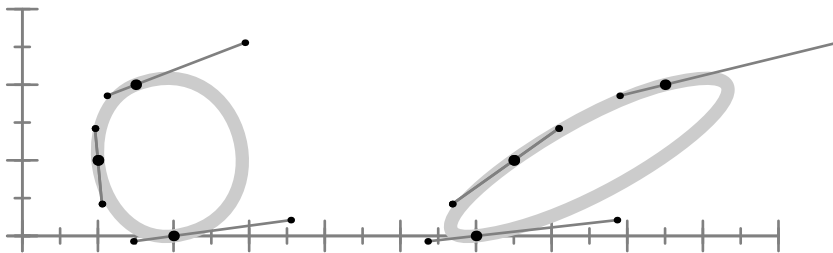

The slant operation's main application is in tilting fonts. The x -coordinates are increased by a percentage of their y -coordinate, so here every x becomes $x + 1.5y$. The y -coordinate is left untouched. The following table summarizes the most important primitive transformations that METAPOST supports.

METAPOST code	mathematical equivalent
(x,y) shifted (a,b)	$(x + a, y + b)$
(x,y) scaled s	(sx, sy)
(x,y) xscaled s	(sx, y)
(x,y) yscaled s	(x, sy)
(x,y) zscaled (u,v)	$(xu - yv, xv + yu)$
(x,y) slanted s	$(x + sy, y)$
(x,y) rotated r	$(x \cos(r) - y \sin(r), x \sin(r) + y \cos(r))$

The previously mentioned `rotatedaround` is not a primitive but a macro, defined in terms of shifts and rotations. Another transformation macro is mirroring, or in METAPOST terminology, `reflectedabout`.

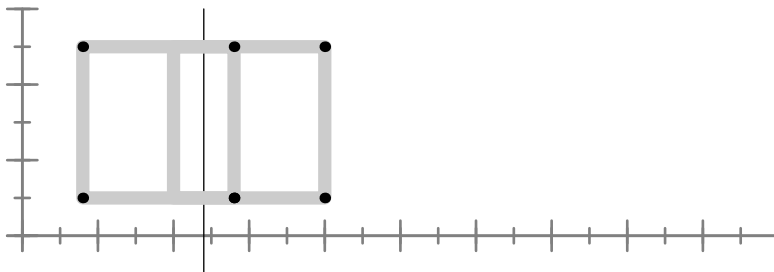

The reflection axis is specified by a pair of points. For example, in the graphic above, we used the following command to reflect the square about a line through the given points.

```
p reflectedabout((2.4cm,-.5),(2.4cm,3cm))
```

The line about which the path is mirrored. Mirroring does not have to be parallel to an axis.

```
p reflectedabout((2.4cm,-.5),(2.6cm,3cm))
```

The rectangle now becomes:

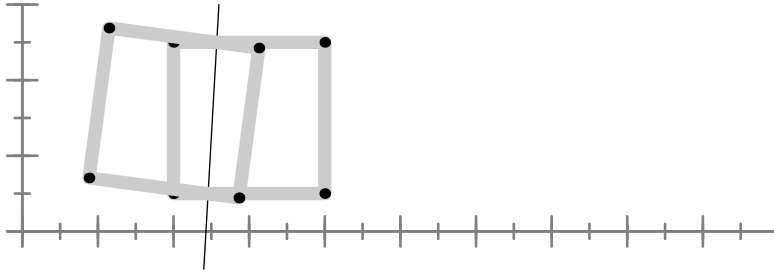

The table also mentions `zscaled`.

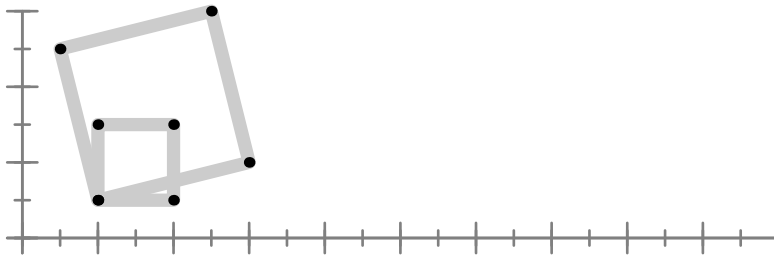

A `zscaled` specification takes a vector as argument:

```
p zscaled (2,.5)
```

The result looks like a combination of scaling and rotation, and conforms to the formula in the previous table.

Transformations can be defined in terms of a transform matrix. Such a matrix is stored in a transform variable. For example:

```
transform t ; t := identity scaled 2cm shifted (4cm,1cm) ;
```

We use the associated keyword `transformed` to apply this matrix to a path or picture.

```
p transformed t
```

In this example we've taken the `identity` matrix as starting point but you can use any predefined transformation. The `identity` matrix is defined in such a way that it scales by a factor of one in both directions and shifts over the zero-vector.

Transform variables can save quite some typing and may help you to force consistency when many similar transformations are to be done. Instead of changing the scaling, shifting and other transformations you can then stick to just changing the one transform variable.

1.3 Constructing paths

In most cases, a path will have more points than the few shown here. Take for instance a so called *super ellipse*.

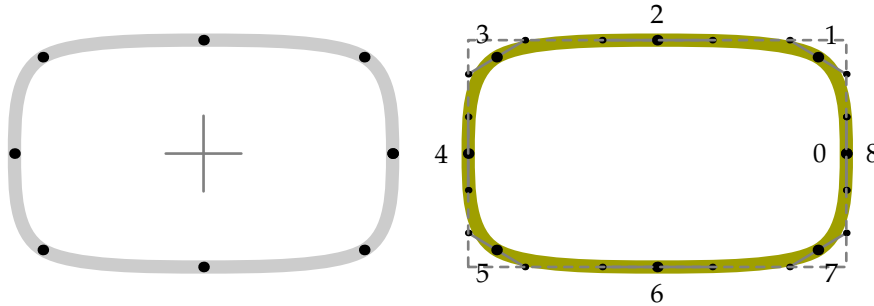

These graphics provide a lot of information. In this picture the crosshair in the center is the *origin* and the dashed rectangle is the *bounding box* of the super ellipse. The bounding box specifies the position of the graphic in relation to the origin as well as its width and height.

In the graphic on the right, you can see the points that make up the closed path as well as the control points. Each point has a number with the first point numbered zero. Because the path is closed, the first and last point coincide.

We've used the commands `..` and `--` as path connecting directives. In the next series of examples, we will demonstrate a few more. However, before doing that, we define a few points, using the predefined `z` variables.

```
z0 = (0.5cm,1.5cm) ; z1 = (2.5cm,2.5cm) ;
z2 = (6.5cm,0.5cm) ; z3 = (3.0cm,1.5cm) ;
```

Here `z1` is a short way of saying `(x1,y1)`. When a `z` variable is called, the corresponding `x` and `y` variables are available too. Later we will discuss METAPOST capability to deal with expressions, which are expressed using an `=` instead of `:=`. In this case the expression related to `z0` is expanded into:

```
z0 = (x0,y0) = (0.5cm,1.5cm) ;
```

But for this moment let's forget about their expressive nature and simply see them as points which we will now connect by straight line segments.

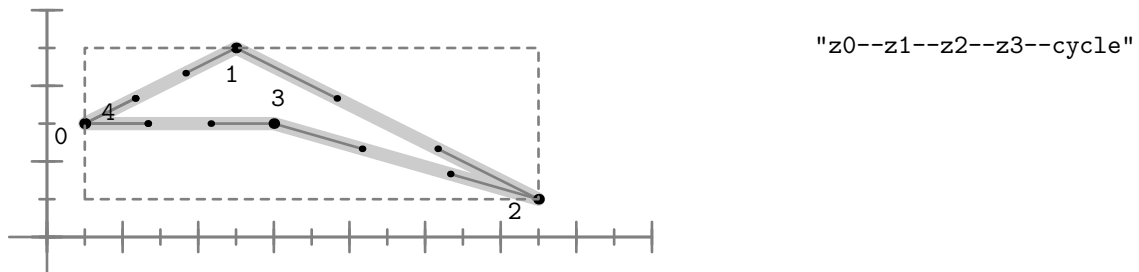

The smooth curved connection, using `..` looks like:

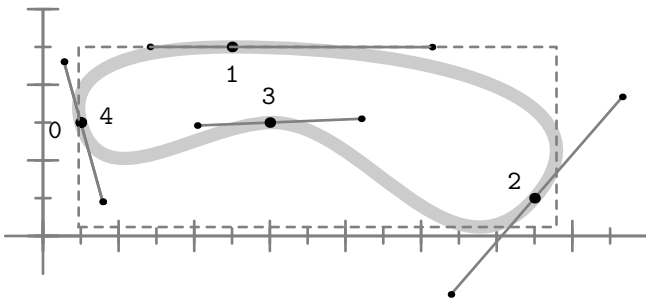

"z0..z1..z2..z3..cycle"

If we replace the .. by ..., we get a tighter path.

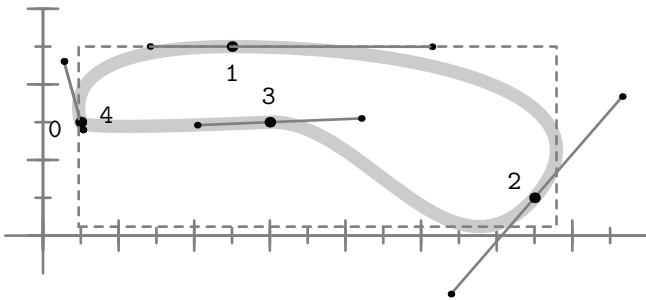

"z0...z1...z2...z3...cycle"

Since there are .., --, and ..., it will be no surprise that there is also ---.

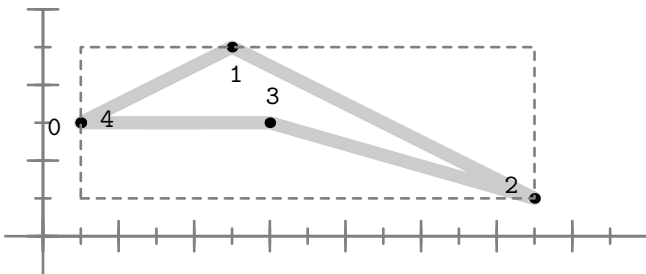

"z0---z1---z2---z3---cycle"

If you compare this graphic with the one using -- the result is the same, but there is a clear difference in control points. As a result, combining .. with -- or --- makes a big difference. Here we get a non-smooth connection between the curves and the straight line.

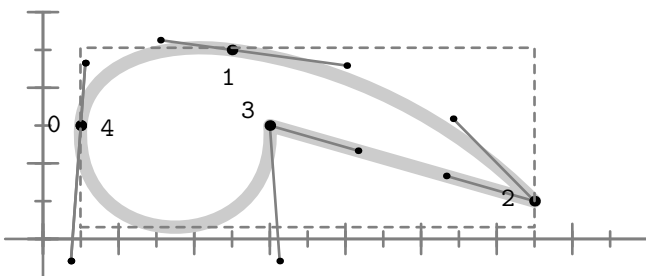

"z0..z1..z2--z3..cycle"

As you can see in the next graphic, when we use ---, we get a smooth connection between the straight line and the rest of the curve.

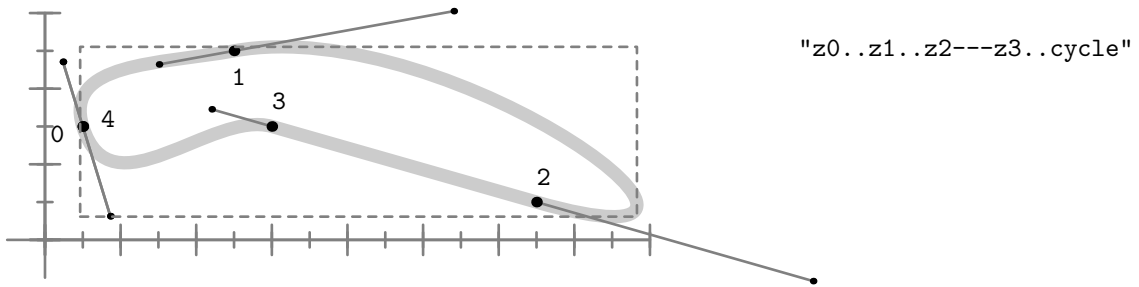

So far, we have joined the four points as one path. Alternatively, we can constrict subpaths and connect them using the ampersand symbol, &.

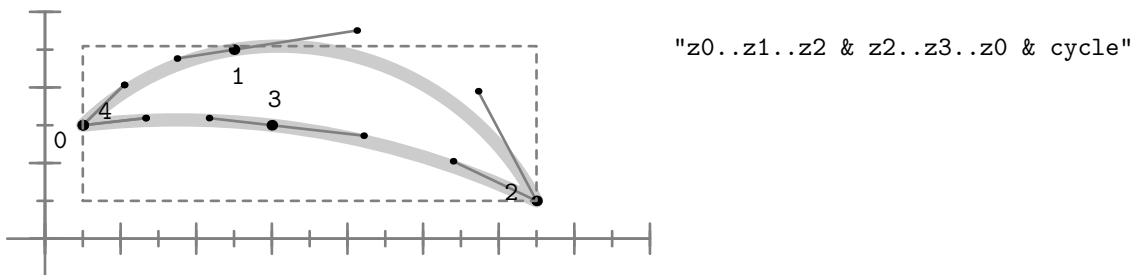

So far we have created a closed path. Closing is done by cycle. The following path may look closed but is in fact open.

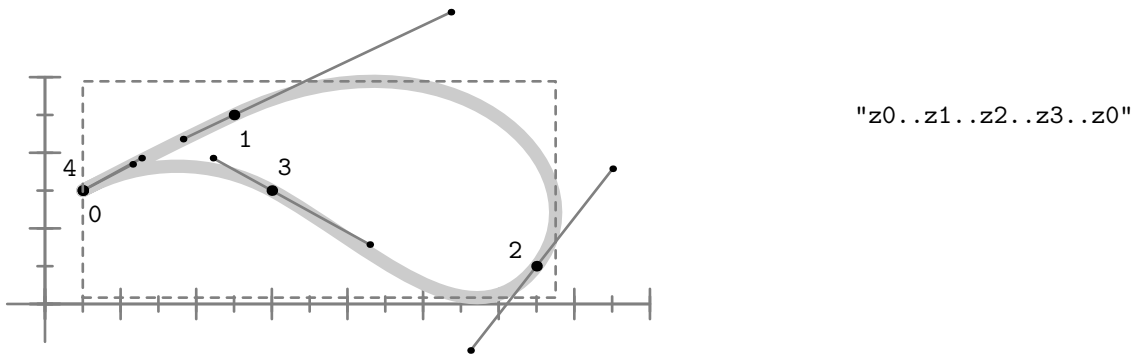

Only a closed path can be filled. The closed alternative looks as follows. We will see many examples of filled closed paths later on.

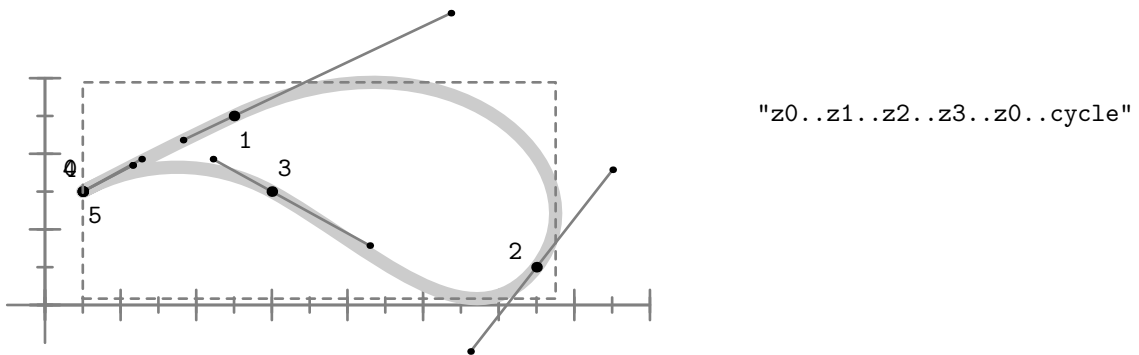

Here the final `..` will try to make a smooth connection, but because we already are at the starting point, this is not possible. However, the `cycle` command can automatically connect to the first point. Watch the difference between the previous and the next path.

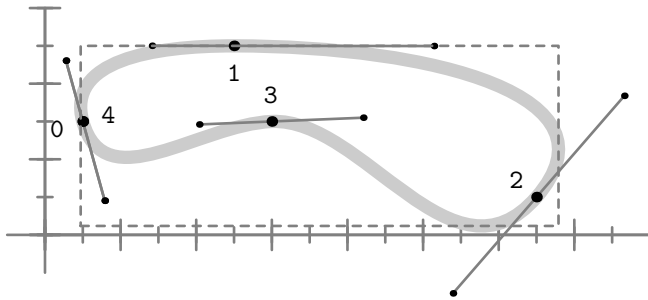

`"z0..z1..z2..z3..cycle"`

It is also possible to combine two paths into one that don't have common head and tails. First we define an open path:

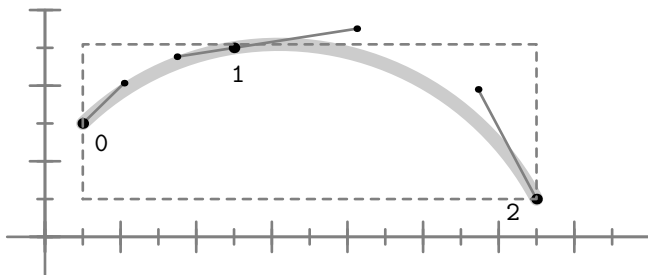

`"z0..z1..z2"`

The following path is a closed one, and crosses the previously shown path.

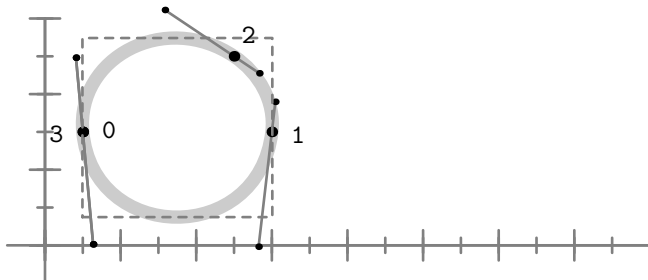

`"z0..z3..z1..cycle"`

With `buildcycle` we can combine two paths into one.

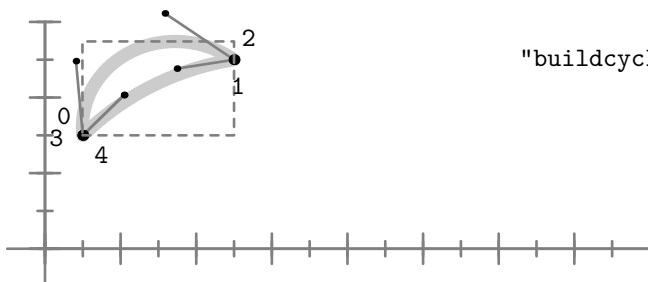

`"buildcycle(z0..z1..z2 , z0..z3..z1..cycle)"`

We would refer readers to the METAFONT book and the METAPost manual for an explanation of the intricacies of the `buildcycle` command. It is an extremely complicated command, and there is just not enough room here to do it justice. We suffice with saying that the paths should cross at

least once before the `buildcycle` command can craft a combined path from two given paths. We encourage readers to experiment with this command.

In order to demonstrate another technique of joining paths, we first draw a few strange paths. The last of these three graphics demonstrates the use of `softjoin`.

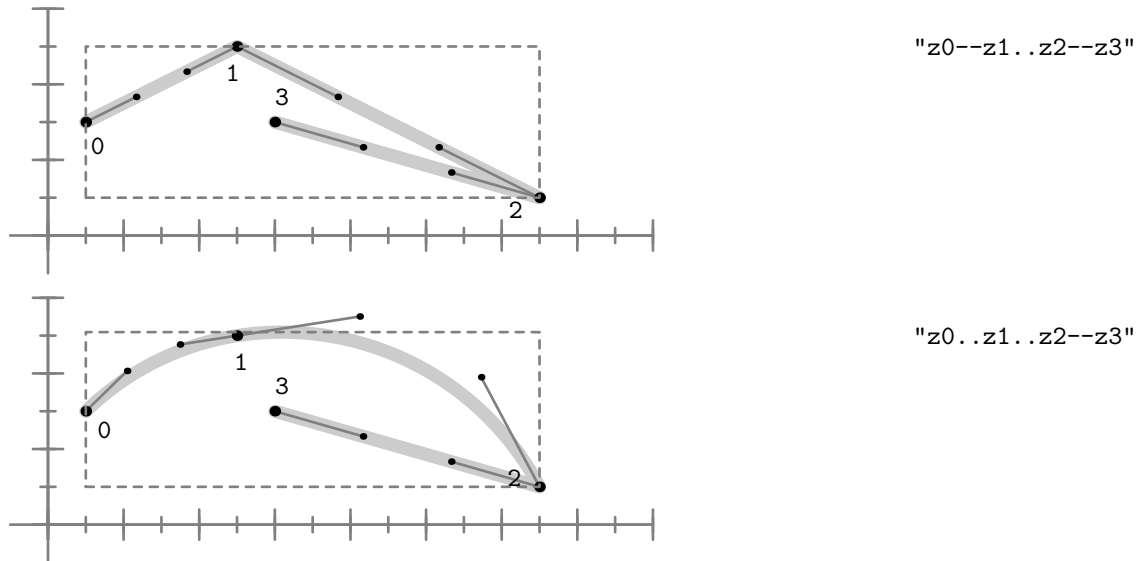

Watch how `softjoin` removes a point in the process of smoothing a connection. The smoothness is accomplished by adapting the control points of the neighbouring points in the appropriate way.

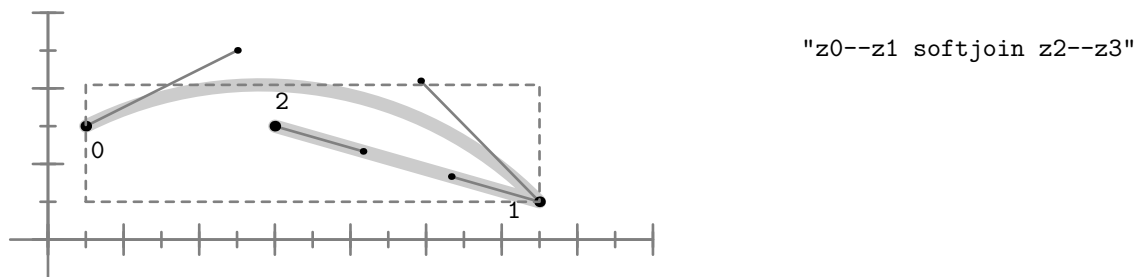

Once a path is known, you can cut off a slice of it. We will demonstrate a few alternative ways of doing so, but first we show one more time the path that we take as starting point.

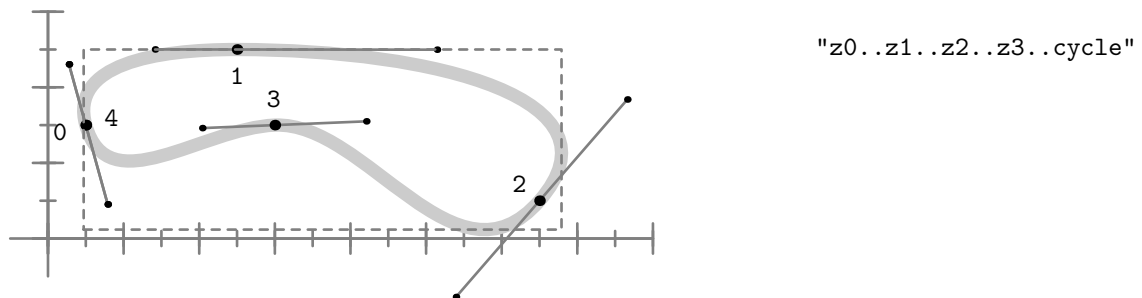

This path is made up out of five points, where the cycle duplicates the first point and connects the loose ends. The first point has number zero.

We can use these points in the `subpath` command, which takes two arguments, specifying the range of points to cut off of the path specified after the keyword `of`.

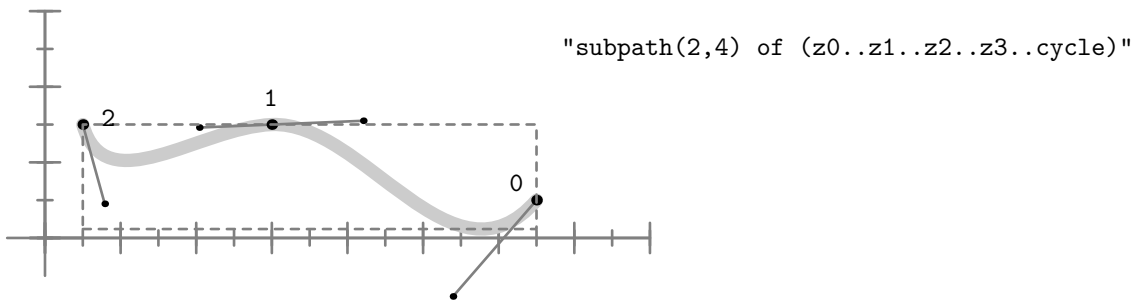

The new (sub)path is a new path with its own points that start numbering at zero. The next graphic shows both the original and the subpath from point 1 upto 3.

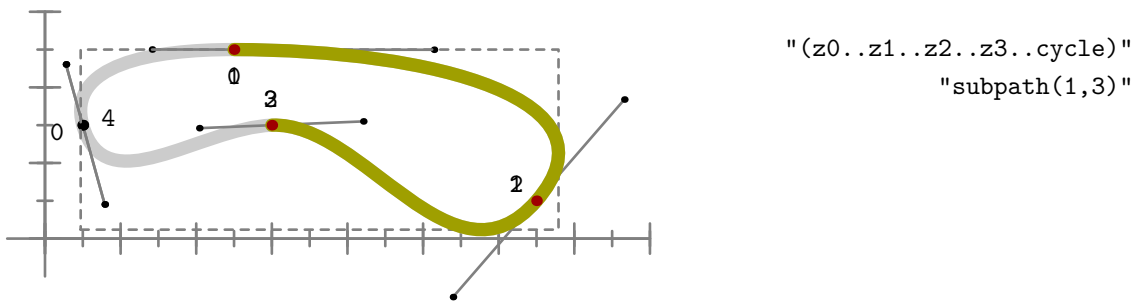

In spite of what you may think, a point is not fixed. This is why in METAPost a point along a path is officially called a time. The next example demonstrates that we can specify any time on the path.

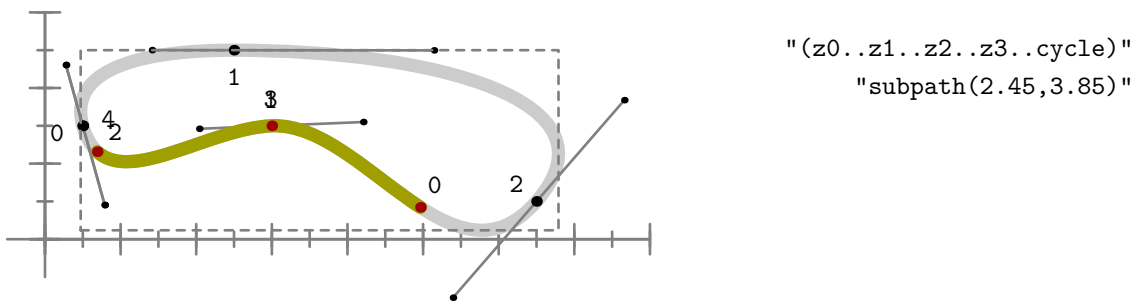

Often we want to take a slice starting at a specific point. This is provided by `cutafter` and its companion `cutbefore`. Watch out, this time we use a non-cyclic path.

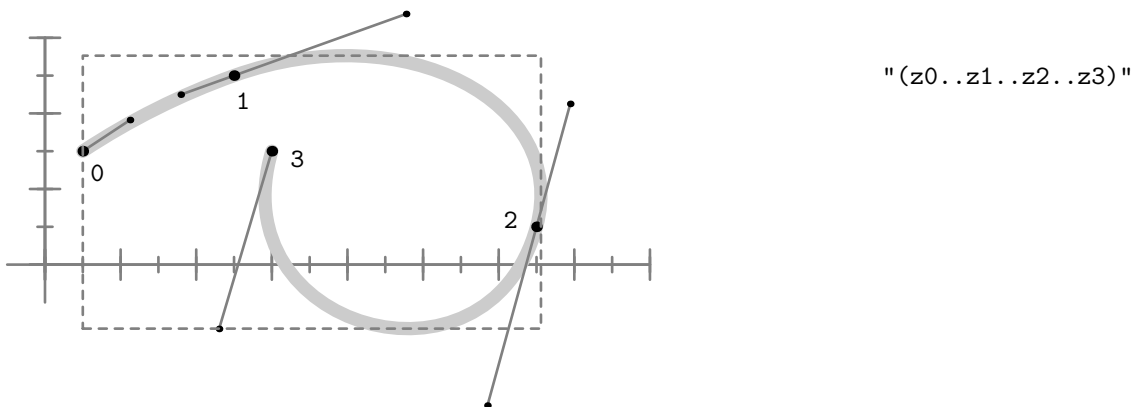

When you use `cutafter` and `cutbefore` it really helps if you know in what direction the path runs.

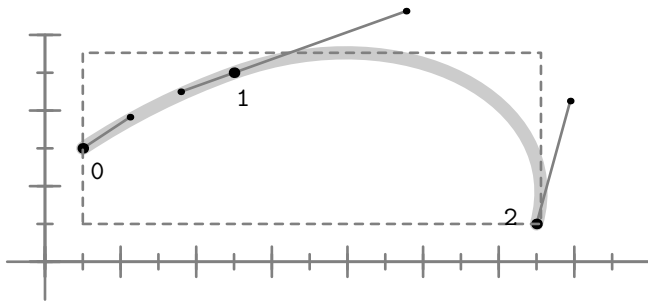

"(z0..z1..z2..z3) cutafter z2"

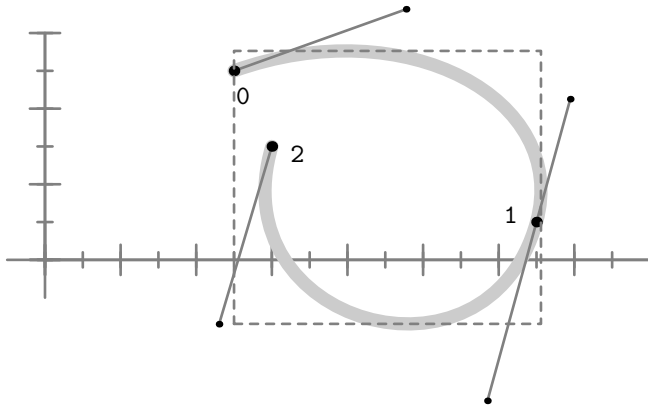

"(z0..z1..z2..z3) cutbefore z1"

Here is a somewhat silly way of accomplishing the same thing, but it is a nice introduction to METAPOST's point operation. In order to use this command effectively, you need to know how many points make up the path.

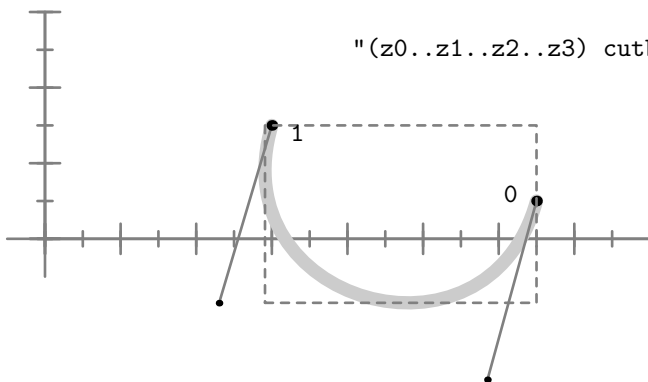

"(z0..z1..z2..z3) cutbefore point 2 of (z0..z1..z2..z3)"

As with subpath, you can use fractions to specify the time on the path, although the resulting point is not necessarily positioned linearly along the curve.

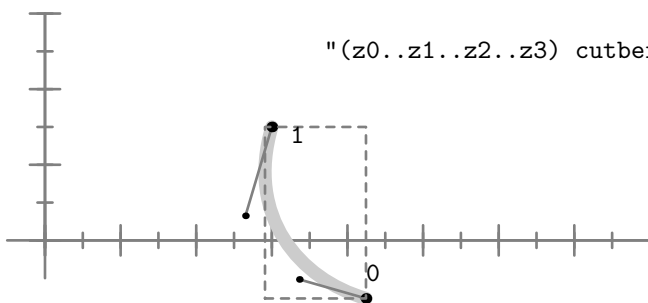

"(z0..z1..z2..z3) cutbefore point 2.5 of (z0..z1..z2..z3)"

If you really want to know the details of where fraction points are positioned, you should read the METAFONT book and study the source of METAFONT and METAPOST, where you will find the complicated formulas that are used to calculate smooth curves.



Like any closed path, this path has points where the tangent is horizontal or vertical. Early in this chapter we mentioned that a pair (or point) can specify a direction or vector. Although any angle is possible, we often use one of four predefined directions:

```
right ( 1, 0)
up    ( 0, 1)
left  (-1, 0)
down  ( 0,-1)
```

We can use these predefined directions in combination with `directionpoint` and `cutafter`. The following command locates the first point on the path that has a tangent that points vertically upward, and then feeds this point to the `cutafter` command.

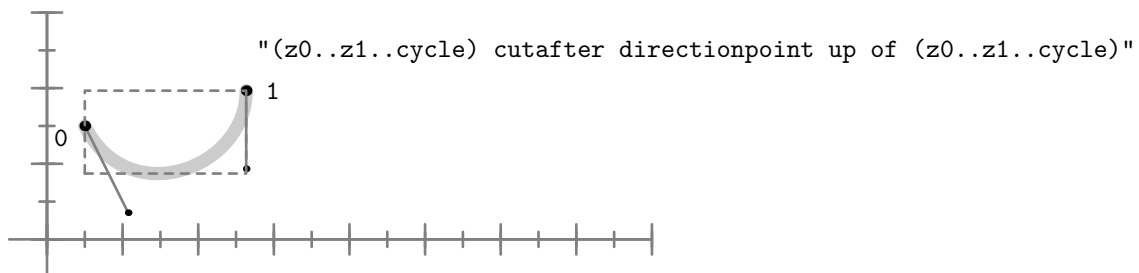

You are not limited to predefined direction vectors. You can provide a pair to indicate a direction. In the next example we use the following cyclic path:

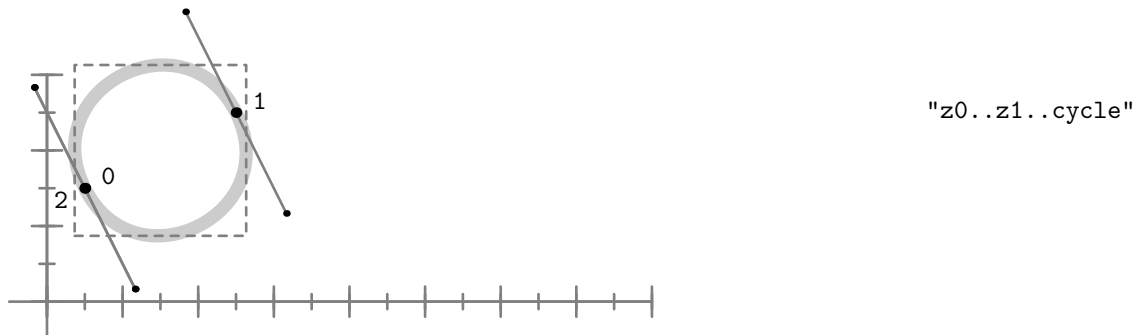

Using `()` is not mandatory but makes the expression look less complicated.

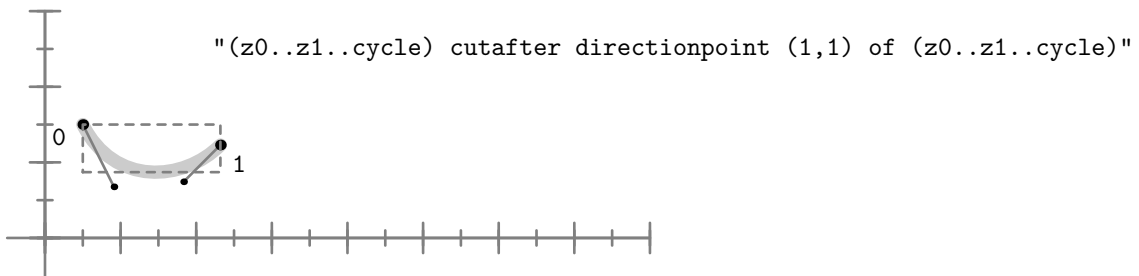

We will apply these commands in the next chapters, but first we will finish our introduction in METAPOST. We have seen how a path is constructed and what can be done with it. Now it is time to demonstrate how such a path is turned into a graphic.

1.4 Angles

You can go from angles to vectors and vice versa using the `angle` and `dir` functions. The next example show both in action.

```
pickup pencircle scaled 2mm ;
draw (origin -- dir(45) -- dir(0) -- cycle)
    scaled 3cm withcolor .625red ;
draw (origin -- dir(angle(1,1)) -- dir(angle(1,0)) -- cycle)
    scaled 3cm shifted (3.5cm,0) withcolor .625yellow ;
draw (origin -- (1,1) -- (1,0) -- cycle)
    scaled 3cm shifted (7cm,0) withcolor .625white ;
```

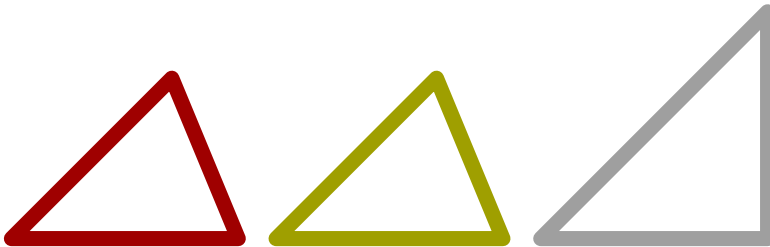

The `dir` command returns an unit vector, which is why the first two shapes look different and are smaller than the third one. We can compensate for that by an additional scaling:

```
pickup pencircle scaled 2mm ;
draw (origin -- dir(45) -- dir(0) -- cycle)
    scaled sqrt(2) scaled 3cm withcolor .625red ;
draw (origin -- dir(angle(1,1)) -- dir(angle(1,0)) -- cycle)
    scaled sqrt(2) scaled 3cm shifted (4.5cm,0) withcolor .625yellow ;
draw (origin -- (1,1) -- (1,0) -- cycle)
    scaled 3cm shifted (9cm,0) withcolor .625white ;
```

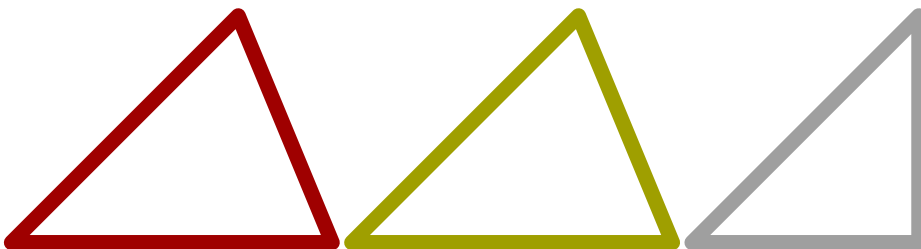

1.5 Drawing pictures

Once a path is defined, either directly or as a variable, you can turn it into a picture. You can draw a path, like we did in the previous examples, or you can fill it, but only if it is closed.

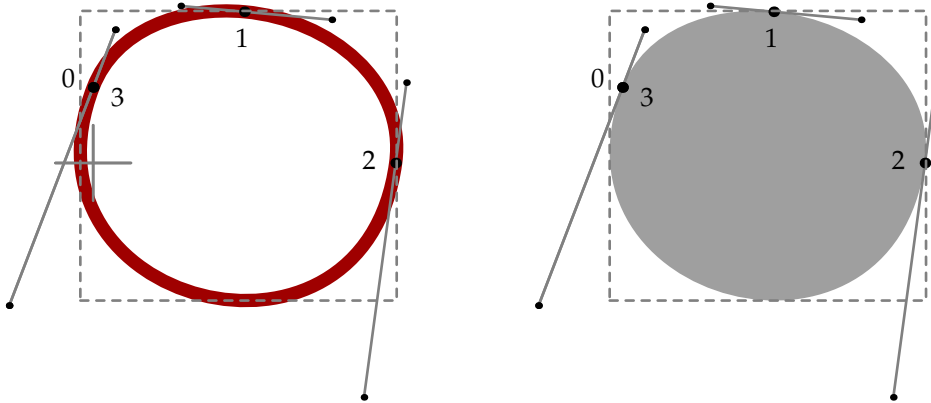

Drawing is done by applying the draw command to a path, as in:

```
draw (0cm,1cm)..(2cm,2cm)..(4cm,0cm)..cycle ;
```

The rightmost graphic was made with fill:

```
fill (0cm,1cm)..(2cm,2cm)..(4cm,0cm)..cycle ;
```

If you try to duplicate this drawing, you will notice that you will get black lines instead of red and a black fill instead of a gray one. When drawing or filling a path, you can give it a color, use all kinds of pens, and achieve special effects like dashes or arrows.

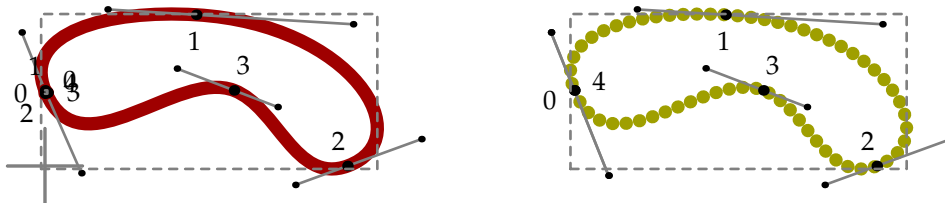

These two graphics were defined and drawn using the following commands. Later we will explain how you can set the line width (or penshape in terms of METAPOST).

```
path p ; p := (0cm,1cm)..(2cm,2cm)..(4cm,0cm)..(2.5cm,1cm)..cycle ;
drawarrow p withcolor .625red ;
draw p shifted (7cm,0) dashed withdots withcolor .625yellow ;
```

Once we have drawn one or more paths, we can store them in a picture variable. The straightforward way to store a picture is to copy it from the current picture:

```
picture pic ; pic := currentpicture ;
```

The following command effectively clears the picture memory and allows us to start anew.

```
currentpicture := nullpicture ;
```

We can shift, rotate and slant the picture stored in pic as we did with paths. We can say:

```
draw pic rotated 45 withcolor red ;
```

A picture can hold multiple paths. You may compare a picture to grouping as provided by drawing applications.

```
draw (0cm,0cm)--(1cm,1cm) ; draw (1cm,0cm)--(0cm,1cm) ;
picture pic ; pic := currentpicture ;
draw pic shifted (3cm,0cm) ; draw pic shifted (6cm,0cm) ;
pic := currentpicture ; draw pic shifted (0cm,2cm) ;
```

We first draw two paths and store the resulting 'cross' in a picture variable. Then we draw this picture two times, so that we now have three copies of the cross. We store the accumulated drawing again, so that after duplication, we finally get six crosses.

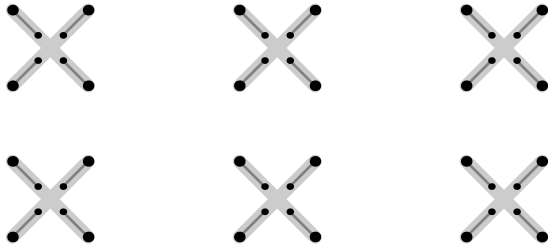

You can often follow several routes to reach the same solution. Consider for instance the following graphic.

```
fill (0,0)--(ww,0)--(ww,hh)--(w,hh)--(w,h)--(0,h)--cycle ;
fill (ww,0)--(w,0)--(w,hh)--cycle ;
```



The points that are used to construct the paths are defined using the constants w , h , ww and hh . These are defined as follows:

```
w := 4cm ; h := 2cm ; ww := 1cm ; hh := 1.5cm ;
```

In this case we draw two shapes that leave part of the rectangle uncovered. If you have a background, this technique allows the background to 'show through' the graphic.

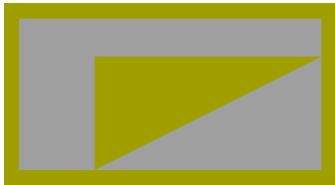

A not uncommon practice when making complicated graphics is to use unfill operations. Since METAPOST provides one, let us see what happens if we apply this command.

```
fill (0,0)--(w,0)--(w,h)--(0,h)--cycle ;
unfill (ww,0)--(w,hh)--(ww,hh)--cycle ;
```

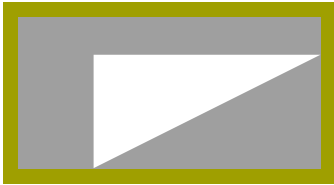

This does not always give the desired effect, because METAPOST's `unfill` is not really an unfill, but a `fill` with color background. Since this color is white by default, we get what we just showed. So, if we set background to black, using `background := black`, we get:

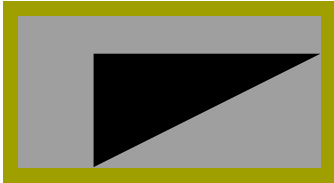

Of course, you can set the variable `background` to a different color, but this does not hide the fact that METAPOST lacks a real unfill operation.

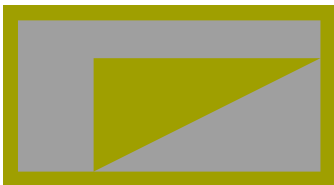

Since we don't consider this `unfill` a suitable operator, you may wonder how we achieved the above result.

```
fill (0,0)--(0,h)--(w,h)--(w,0)--(ww,0)--(w,hh)--(ww,hh)--
      (ww,0)--cycle ;
```

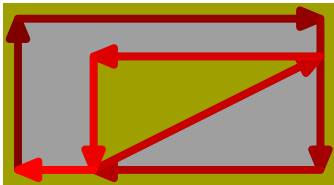

This feature depends on the POSTSCRIPT way of filling closed paths, which comes down to filling either the left or the right hand side of a curve. The following alternative works too.

```
fill (0,0)--(0,h)--(w,h)--(w,hh)--(ww,hh)--(ww,0)--(w,hh)--
      (w,0)--cycle ;
```

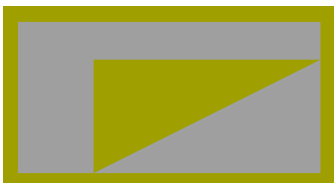

The next alternative will fail. This has to do with the change in direction at point $(0,0)$ halfway through the path. Sometimes changing direction can give curious but desirable effects, but here it brings no good.

```
fill (0,0)--(0,h)--(w,h)--(w,0)--(0,0)--(ww,0)--(ww,hh)--
      (w,hh)--(ww,0)--cycle ;
```

This path fails because of the way POSTSCRIPT implements its fill operator. More details on how POSTSCRIPT defines fills can be found in the reference manuals.



Some of the operations we have seen are hard coded into METAPOST and are called primitives. Others are defined as macros, that is, a sequence of METAPOST commands. Since they are used often, you may expect `draw` and `fill` to be primitives, but they are not. They are macros defined in terms of primitives.

Given a path `pat`, you can consider a `draw` to be defined in terms of:

```
addto currentpicture doublepath pat
```

The `fill` command on the other hand is defined as:

```
addto currentpicture contour pat
```

Both macros are actually a bit more complicated but this is mainly due to the fact that they also have to deal with attributes like the pen and color they draw with.

You can use `doublepath` and `contour` directly, but we will use `draw` and `fill` whenever possible.

Given a picture `pic`, the following code is valid:

```
addto currentpicture also pic
```

You can add pictures to existing picture variables, where `currentpicture` is the picture that is flushed to the output file. Watch the subtle difference between adding a `doublepath`, `contour` or `picture`.

1.6 Variables

At this point you may have noted that METAPOST is a programming language. Contrary to some of today's languages, METAPOST is a simple and clean language. Actually, it is a macro language. Although METAPOST and \TeX are a couple, the languages differ in many aspects. If you are using both, you will sometimes wish that features present in one would be available in the other. When using both languages, in the end you will understand why the conceptual differences make sense.

Being written in PASCAL, it will be no surprise that METAPOST has some PASCAL-like features, although some may also recognize features from ALGOL68 in it.

First there is the concept of variables and assignments. There are several data types, some of which we already have seen.

numeric	real number in the range $-4096\dots +4096$
boolean	a variable that takes one of two states: true or false
pair	point or vector in 2-dimensional space
path	a piecewise collection of curves and line segments
picture	collection of stroked or filled paths
string	sequence of characters, like "metapost"
color	vector of three (rgb) or four (cmyk) numbers

There are two additional types, `transform` and `pen`, but we will not discuss these in depth.

transform	transformation vector with six elements
pen	pen specification

You can achieve interesting effects by using pens with certain shapes. For the moment you may consider a pen to be a path itself that is applied to the path that is drawn.

The `numeric` data type is used so often that it is the default type of any non declared variable. This means that

```
n := 10 ;
```

is the same as

```
numeric n ; n := 10 ;
```

When writing collections of macros, it makes sense to use the second method, because you can never be sure if `n` isn't already declared as a picture variable, and assigning a numeric to a picture variable is not permitted.

Because we often deal with collections of objects, such as a series of points, all variables can be organized in arrays. For instance:

```
numeric n[] ; n[3] := 10 ; n[5] := 13 ;
```

An array is a collection of variables of the same type that are assigned and accessed by indexing the variable name, as in `n[3] := 5`. Multi-dimensional arrays are also supported. Since you need a bit of imagination to find an application for 5-dimensional arrays, we restrict ourselves to a two-dimensional example.

```
numeric n[][] ; n[2][3] := 10 ;
```

A nice feature is that the bounds of such an array needs not to be set beforehand. This also means that each cell that you access is reported as *unknown* unless you have assigned it a value.

Behind the screens there are not really arrays. It's just a matter of creating hash entries. It might not be obvious, but the following assignments are all equivalent:

```
i_111_222      := 1cm ;
i_[111]_[222] := 1cm ;
i_[111][222]   := 1cm ;
draw
  image (
    draw (0cm,i_111_222) ;
    draw (1cm,i_[111]_[222]) ;
```

```

        draw (2cm,i_[111][222]) ;
    )
    withpen pencircle scaled 5mm
    withcolor .625 red ;

```

Sometimes METAPOST ways are mysterious:



1.7 Conditions

The existence of boolean variables indicates the presence of conditionals. Indeed, the general form of METAPOST's conditional follows:

```
if n=10 : draw p ; else : draw q ; fi ;
```

Watch the colons after the if and else clause. They may not be omitted. The semi-colons on the other hand, are optional and depend on the context. You may say things like:

```
draw if n=10 : p ; else : q ; fi ;
```

Here we can omit a few semi-colons:

```
draw if n=10 : p else : q fi withcolor red ;
```

Adding semi-colons after p and q will definitely result in an error message, since the semi-colon ends the draw operation and withcolor red becomes an isolated piece of nonsense.

There is no case statement available, but for most purposes, the following extension is adequate:

```
draw p withcolor if n<10 : red elseif n=10 : green else : blue fi ;
```

There is a wide repertoire of boolean tests available.

```

if picture p :
if known    n :
if odd      i :
if cycle    q :

```

Of course, you can use and, or, not, and () to construct very advanced boolean expressions. If you have a bit of programming experience, you will appreciate the extensive support of conditionals in METAPOST.

1.8 Loops

Yet another programming concept present in METAPOST is the loop statement, the familiar 'for loop' of all programming languages.

```

for i=0 step 2 until 20 :
    draw (0,i) ;
endfor ;

```

As explained convincingly in Niklaus Wirth's book on algorithms and datastructures, the for loop is the natural companion to an array. Given an array of length n , you can construct a path out of the points that make up the array.

```
draw for i=0 step 1 until n-1 : p[i] .. endfor p[n] ;
```

If the step increment is not explicitly stated, it has an assumed value of 1. We can shorten the previous loop construct as follows:

```
draw for i=0 upto n-1 : p[i] .. endfor p[n] ;
```

After seeing `if` in action, the following for loop will be no surprise:

```
draw origin for i=0 step 10 until 100 : ..{down}(i,0) endfor ;
```

This gives the zig-zag curve:



You can use a loop to iterate over a list of objects. A simple 3-step iteration is:

```
for i=p,q,r :
  fill i withcolor .8white ;
  draw i withcolor red ;
endfor ;
```

Using `for` in this manner can sometimes save a bit of typing. The list can contain any expression, and may be of different types.

In the previous example the `i` is an independent variable, local to the for loop. If you want to change the loop variable itself, you need to use `for` suffixes. In the next loop the paths `p`, `q` and `r` are all shifted.

```
forsuffixes i = p, q, r :
  i := i shifted (3cm,2cm) ;
endfor ;
```

Sometimes you may want to loop forever until a specific condition occurs. For this, METAPOST provides a special looping mechanism:

```
numeric done[][] , i, j, n ; n := 0 ;
forever :
  i := round(uniformdeviate(10)) ; j := round(uniformdeviate(2)) ;
  if unknown done[i][j] :
    drawdot (i*cm,j*cm) ; n := n + 1 ; done[i][j] := n ;
  fi ;
  exitif n = 10 ;
endfor ;
```

Here we remain in the loop until we have 10 points placed. We use an array to keep track of placed points. The METAPOST macro `uniformdeviate(n)` returns a random number between 0 and n and the `round` command is used to move the result toward the nearest integer. The `unknown` primitive allows us to test if the array element already exists, otherwise we exit the conditional. This saves a bit of computational time as each point is drawn and indexed only once.

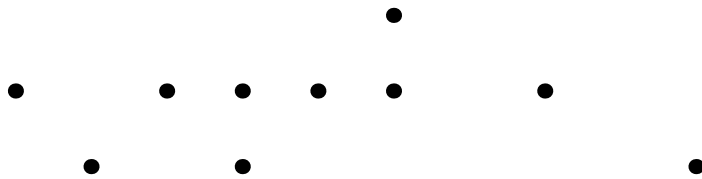

The loop terminator `exitif` and its companion `exitunless` can be used in `for`, `forsuffixes` and `forever`.

1.9 Macros

In the previous section we introduced `upto`. Actually this is not part of the built in syntax, but a sort of shortcut, defined by:

```
def upto = step 1 until enddef ;
```

You just saw a macro definition where `upto` is the name of the macro. The counterpart of `upto` is `downto`. Whenever you use `upto`, it is replaced by `step 1 until`. This replacement is called expansion.

There are several types of macros. A primary macro is used to define your own operators. For example:

```
primarydef p doublescaled s =
  p xscaled (s/2) yscaled (s*2)
enddef ;
```

Once defined, the `doublescaled` macro is implemented as in the following example:

```
draw somepath doublescaled 2cm withcolor red ;
```

When this command is executed, the macro is expanded. Thus, the actual content of this command becomes:

```
draw somepath xscaled 1cm yscaled 4cm withcolor red ;
```

If in the definition of `doublescaled` we had added a semi-colon after `(s*2)`, we could not have set the color, because the semicolon ends the statement. The `draw` expects a path, so the macro can best return one.

A macro can take one or more arguments, as in:

```
def drawrandomscaledpath (expr p, s) =
  draw p xscaled (s/2) yscaled (s*2) ;
enddef ;
```

When using this macro, it is expected that you will pass it two parameters, the first being a path, the second a numeric scale factor.

```
drawrandomscaledpath(fullsquare, 3cm) ;
```

Sometimes we want to return a value from a macro. In that case we must make sure that any calculations don't interfere with the expectations. Consider:

```
vardef randomscaledpath(expr p, s) =
```

```

    numeric r ; r := round(1 + uniformdeviate(4)) ;
    p xscaled (s/r) yscaled (s*r)
enddef ;

```

Because we want to use the same value of `r` twice, we have to use an intermediate variable. By using a `vardef` we hide everything but the last statement. It is important to distinguish `def` macros from those defined with `vardef`. In the latter case, `vardef` macros are not a simple expansion and replacement. Rather, `vardef` macros return the value of their last statement. In the case of the `randomscaledpath` macro, a path is returned. This macro is used in the following manner:

```

path mypath ; mypath := randomscaledpath(unitsquare,4cm) ;

```

Note that we send `randomscaledpath` a path (`unitsquare`) and a scaling factor (`4cm`). The macro returns a scaled path which is then stored in the path variable `mypath`.

The following argument types are accepted:

```

expr    something that can be assigned to a variable
text    arbitrary METAPOST code ending with a ;
suffix  a variable bound to another variable

```

An expression is passed by value. This means that in the body of the macro, a copy is used and the original is left untouched. On the other hand, any change to a variable passed as suffix is also applied to the original.

Local variables must be handled in a special manner, since they may conflict with variables used elsewhere. This is because all variables are global by default. The way out of this problem is using grouping in combination with saving variables. The use of grouping is not restricted to macros and may be used anywhere in your code. Variables saved and declared in a group are local to that group. Once the group is exited the variables cease to exist.

```

vardef randomscaledpath(expr p, s) =
  begingroup ; save r ; numeric r ;
  r := round(1 + uniformdeviate(4)) ;
  p xscaled (s/r) yscaled (s*r)
endgroup
enddef ;

```

In this particular case, we could have omitted the grouping, since `vardef` macros are always grouped automatically. Therefore, we could have defined the macro as:

```

vardef randomscaledpath(expr p, s) =
  save r ; numeric r ; r := round(1 + uniformdeviate(4)) ;
  p xscaled (s/r) yscaled (s*r)
enddef ;

```

The command `save r` declares that the variable `r` is local to the macro. Thus, any changes to the (new) numeric variable `r` are local and will not interfere with a variable `r` defined outside the macro. This is important to understand, as variables outside the macro are global and accessible to the code within the body of the macro.

Macro definitions may be nested, but since most METAPOST code is relatively simple, it is seldom needed. Nesting is discouraged as it makes your code less readable.

Besides `def` and `vardef`, METAPOST also provides the classifiers `primarydef`, `secondarydef` and `tertiarydef`. You can use these classifiers to define macros like those provided by METAPOST itself:

```
primarydef  x mod                y = ... enddef ;
secondarydef p intersectionpoint q = ... enddef ;
tertiarydef p softjoin           q = ... enddef ;
```

A primary macro acts like the binary operators `*` or `scaled` and `shifted`. Secondary macros are like `+`, `-` and logical `or`, and take less precedence. The tertiary operators like `<` or the path and string concatenation operator `&` have tertiary macros as companions. More details can be found in the METAFONT book. When it comes to taking precedence, METAPOST tries to be as natural as possible, in the sense that you need to provide as few `()`'s as possible. When in doubt, or when surprised by unexpected results, use parentheses.

1.10 Arguments

The METAPOST macro language is rather flexible in how you feed arguments to macros. If you have only one argument, the following definitions and calls are valid.

```
def test  expr a = enddef ; test (a) ; test a ;
def test (expr a) = enddef ; test (a) ; test a ;
```

A more complex definition is the following. As you can see, you can call the `test` macro in your favorite way.

```
def test (expr a,b) (expr c,d) = enddef ;
test (a) (b) (c) (d) ;
test (a,b) (c,d) ;
test (a,b,c) (d) ;
test (a,b,c,d) ;
```

The type of the arguments is one of `expr`, `primary` or `suffix`. When fetching arguments, METAPOST uses the type to determine how and what to grab. A fourth type is `text`. When no parenthesis are used, a `text` argument grabs everything upto the next semicolon.

```
def test (expr a) text b = enddef ;
test (a) ; test (a) b ;
```

You can use a `text` to grab arguments like `withpen pencircle scaled 10 withcolor red`. Because `text` is so hungry, you may occasionally need a two stage definition:

```
def test  expr a          = dotext(a) enddef ;
def dotest (expr a) text b = ...          enddef ;
test a ; test a b ;
```

This definition permits arguments without parenthesis, which is something you want with commands like `draw`.

The `vardef` alternative behaves in a similar way. It always provides grouping. You need to generate a return value and as a result may not end with a semicolon.

You may consider the whole `vardef` to be encapsulated into parenthesis and thereby to be a (self contained) variable. Adding additional parenthesis often does more harm than good:

```
vardef test (expr a) =
  ( do tricky things with a ; manipulated_a )
enddef ;
```

Here the tricky things become part of the return value, which quite certainly is something that you don't want.

The three operator look-alike macro definitions are less flexible and have the definition scheme:

```
primarydef x test y = enddef ;
secondarydef x test y = enddef ;
tertiarydef x test y = enddef ;
```

When defining macros using this threesome you need to be aware of the associated priorities. When using these definitions, you also have to provide your own grouping.

In the plain METAPOST macro collection (`plain.mp`) you can find many examples of clever definitions. The following (simplified) version of `min` demonstrates how we use the argument handler to isolate the first argument from the provided list, simply by using two arguments.

```
vardef min (expr u) (text t) =
  save min_u ; min_u := u ;
  for uu = t : if uu < u : min_u := uu ; fi endfor
  min_u
enddef ;
```

The special sequence `@#` is used to pick up a so called delimited argument:

```
vardef TryMe@#(expr x) =
  % we can now use @#, which is just text
enddef ;
```

This feature is used in the definition of `z` as used in `z1` or `z234`:

```
vardef z@# = (x@#,y@#) enddef ;
```

Other applications can be found in the label drawing macros where the anchor point is assigned to the obscure variable `@#`.

1.11 Pens

When drawing, three attributes can be applied to it: a dashpattern, a pen and/or a color. You may consider an arrowhead an attribute, but actually it is just an additional drawing, appended to the path.

The (predefined) `pencircle` attribute looks like:

```
withpen pencircle
```

where `pencircle` is a special kind of path, stored in a pen variable. Like any path, you can transform it. You can scale it equally in all directions:

```
withpen pencircle scaled 1mm
```

You can also provide unequal scales, creating an elliptically shaped and rotated pen.

```
withpen pencircle xscaled 2mm yscaled 4mm rotated 30
```

In the following graphic, the circle in the center is drawn without any option, which means that the default pen is used, being a pencircle with a radius of half a base point. The other three circles are drawn with different pen specifications.

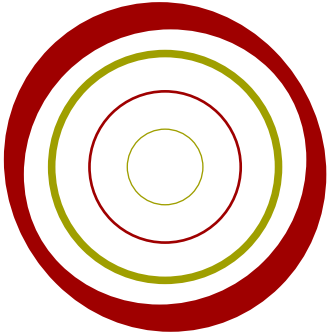

If you forget about the colors, the METAPost code to achieve this is as follows.

```
path p ; p := fullcircle scaled 1cm ;
draw p ;
draw p scaled 2 withpen pencircle ;
draw p scaled 3 withpen pencircle scaled 1mm ;
draw p scaled 4 withpen pencircle xscaled 2mm yscaled 4mm rotated 30 ;
```

If this were the only way of specifying a pen, we would be faced with a considerable amount of typing, particularly in situations where we use pens similar to the fourth specification above. For that reason, METAPost supports the concept of a current pen. The best way to set this pen is to use the `pickup` macro.

```
pickup pencircle xscaled 2mm yscaled 4mm rotated 30 ;
```

This macro also stores some characteristics of the pen in variables, so that they can be used in (the more complicated) calculations that are involved in situations like drawing font-like graphics.

If we substitute `pencircle` by `pensquare`, we get a different kind of shapes. In the non rotated pens, the top, bottom, left and right parts of the curve are thinner.

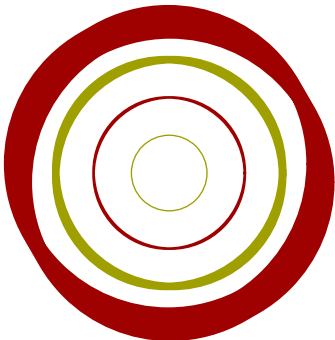

You should look at pens in the way an artist does. He follows a shape and in doing so he or she twists the pen (and thereby the nib) and puts more or less pressure on it.

The chance that you have an appropriate pen laying at your desk is not so big, but you can simulate the following METAPOST's pen by taking two pencils and holding them together in one hand. If you position them in a 45 degrees angle, and draw a circle, you will get something like:

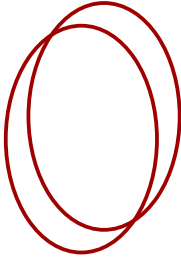

If you take a calligraphic pen with a thin edge of .5cm, you will get:

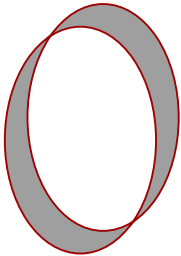

You can define such a pen yourself:

```
path p ; p := fullcircle xscaled 2cm yscaled 3cm ;
pen doublepen ; doublepen := makepen ((0,0)--(.3cm,.3cm)) ;
pickup doublepen ; draw p ;
```

Here we define a new pen using the pen command. Then we define a path, and make a pen out of it using the makepen macro. The path should be a relatively simple one, otherwise METAPOST will complain.

You can use makepen with the previously introduced withpen:

```
draw p withpen makepen ((0,0)--(.3cm,.3cm)) ;
```

and pickup:

```
pickup makepen ((0,0)--(.3cm,.3cm)) ; draw p ;
```

You can use makepen and makepath to convert paths into pens and vice versa.

Pens are very important when defining fonts, and METAFONT is meant to be a font creation tool. Since METAPOST has a slightly different audience, it lacks some features in this area, but offers a few others instead. Nevertheless, one can try to design a font using METAPOST. Of course, pens are among the designers best kept secrets. But even then, not every O is a nice looking one.

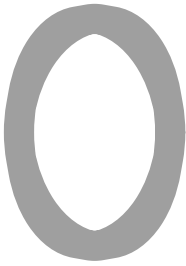

The pensilled macro is a variant on a macro used for testing some border cases in the engine. It provides a nice way to see what actually happens when a pen is applied. Figure 1.1 demonstrates this macro. The first row shows a square pen:

```
path p ; p := (-1,0) {down} .. {up} (1,0) ;
draw pensilled(p, pensquare scaled (1/3) rotated 30)
scaled 2cm ;
draw boundingbox image(draw p)
scaled 2cm ;
```

and the second row a circular pen:

```
path p ; p := (-1,0) {down} .. {up} (1,0) ;
draw pensilled(p, pencircle scaled (1/3) rotated 30)
scaled 2cm ;
draw boundingbox image(draw p)
scaled 2cm ;
```

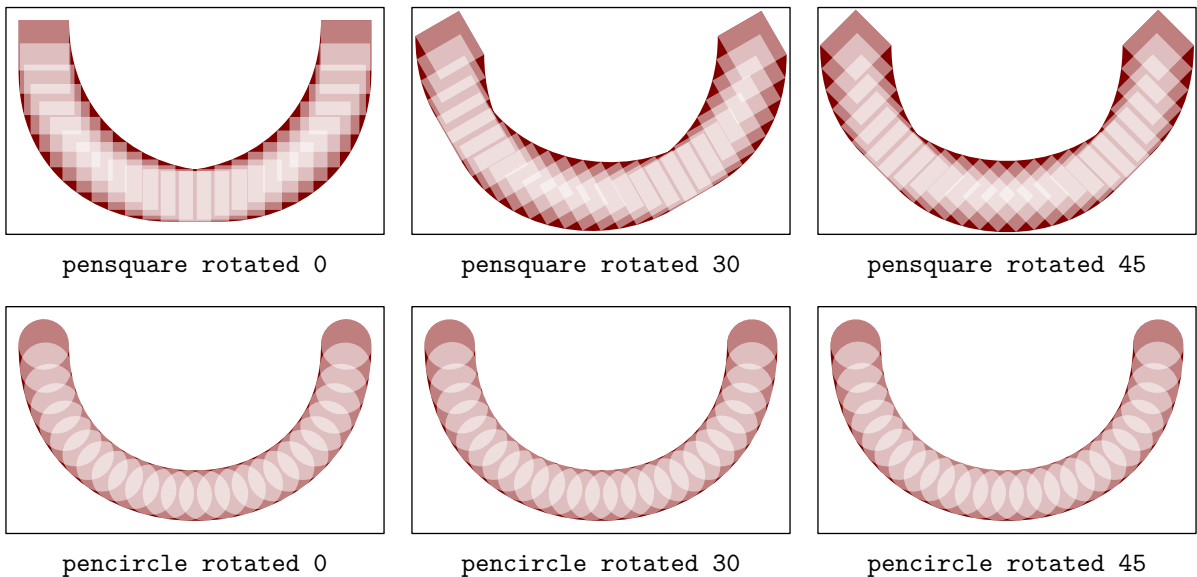

Figure 1.1 How pens are applied.

The effects of rotation and non-proportional scaling are demonstrated in figure 1.2.

```
interim pensilstep := 1/6 ;
draw pensilled(fullcircle, pencircle xscaled (1/10) yscaled (2/10) rotated 30)
scaled 5cm ;
```



```
draw boundingbox fullcircle
scaled 5cm ;
```

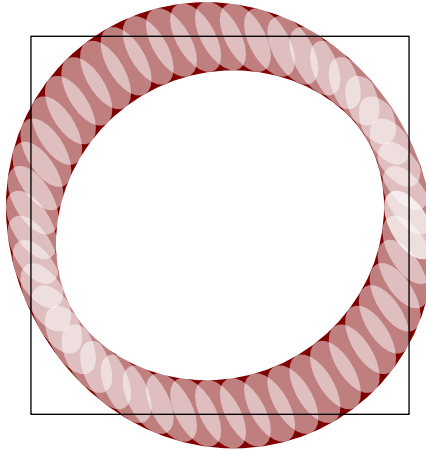

Figure 1.2 A proportionally scaled and rotated pen.

1.12 Joining lines

The way lines are joined or end is closely related to the way POSTSCRIPT handles this. By setting the variables `linejoin` and `linecap`, you can influence the drawing process. Figure 1.3 demonstrates the alternatives. The gray curves are drawn with both variables set to rounded.

By setting the variable `miterlimit`, you can influence the mitering of joints. The next example demonstrates that the value of this variable acts as a trigger.

```
interim linejoin := mitered ;
for i :=1 step 1 until 5 :
  interim miterlimit := i*pt ;
  draw ((0,0)--(.5,1)--(1,0)) shifted (1.5i,0) scaled 50pt
  withpen pencircle scaled 10pt withcolor .625red ;
endfor ;
```

The variables `linejoin`, `linecap` and `miterlimit` are so called *internal* variables. When we prefix their assignments by `interim`, the setting will be local within groups, like `beginfig ... endfig`.



1.13 Colors

So far, we have seen some colors in graphics. It must be said that METAPOST color model is not that advanced, although playing with colors in the METAPOST way can be fun. In later chapters we will discuss some extensions that provide shading.

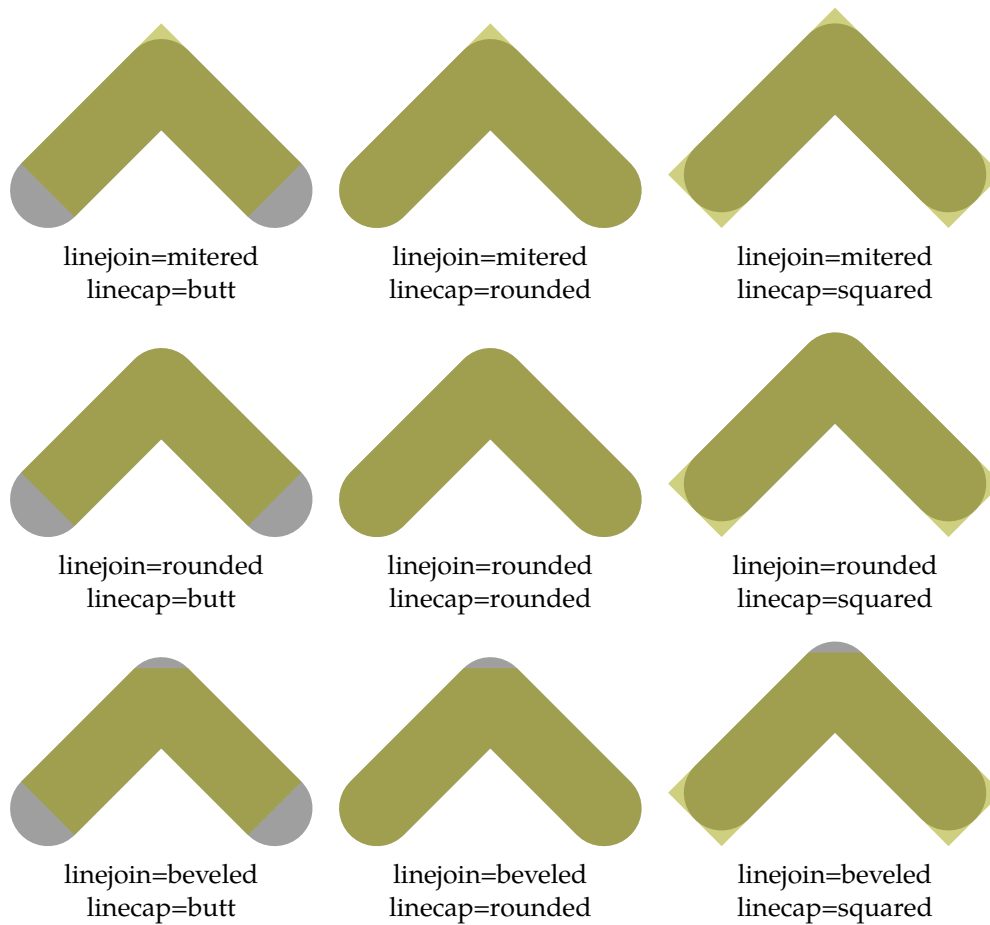

Figure 1.3 The nine ways to end and join lines.

Colors are defined as vectors with three components: a red, green and blue one. Like pens, colors have their `with-`command:

```
withcolor (.4,.5,.6)
```

You can define color variables, like:

```
color darkred ; darkred := (.625,0.0) ;
```

You can now use this color as:

```
withcolor darkred
```

Given that red is already defined, we also could have said:

```
withcolor .625red
```

Because for METAPOST colors are just vectors, you can do things similar to points. A color halfway red and green is therefore accomplished with:

```
withcolor .5[red,green]
```

Since only the RGB color space is supported, this is about all we can tell about colors for this moment. Later we will discuss some nasty details.

1.14 Dashes

A dash pattern is a simple picture that is build out of straight lines. Any slightly more complicated picture will be reduced to straight lines and a real complicated one is rejected, and in this respect METAPOST considers a circle to be a complicated path.

The next example demonstrates how to get a dashed line. First we built picture `p`, that we apply to a path. Here we use a straight path, but dashing can be applied to any path.

```
picture p ; p := nullpicture ;
addto p doublepath ((0,0)--(3mm,3mm)) shifted (6mm,6mm) ;
draw (0,0)--(10cm,0) dashed p withpen pencircle scaled 1mm ;
```

This way of defining a pattern is not that handy, especially if you start wondering why you need to supply a slanted path. Therefore, METAPOST provides a more convenient mechanism to define a pattern.

```
picture p ; p := dashpattern(on 3mm off 3mm) ;
draw (0,0)--(10cm,0) dashed p withpen pencircle scaled 1mm ;
```

Most dashpatterns can be defined in terms of on and off. This simple on-off dashpattern is pre-defined as picture `evenly`. Because this is a picture, you can (and often need to) scale it.

```
draw (0,0)--(10cm,0) dashed (evenly scaled 1mm)
withpen pencircle scaled 1mm ;
```

Opposite to a `defaultpen`, there is no default color and default dash pattern set. The macro `drawoptions` provides you a way to set the default attributes.

```
drawoptions(dashed evenly withcolor red) ;
```

1.15 Text

Since METAFONT is meant for designing fonts, the only means for including text are those that permit you to add labels to positions for the sole purpose of documentation.

Because METAPOST is derived from METAFONT it provides labels too, but in order to let users add more sophisticated text, like a math formula, to a graphic, it also provides an interface to \TeX .

Because we will spend a whole chapter on using text in METAPOST we limit the discussion here to a few fundamentals.

```
pair a ; a := (3cm,3cm) ;
label.top("top",a) ; label.bot("bot",a) ;
label.lft("lft",a) ; label.rt ("rt" ,a) ;
```

These four labels show up at the position stored in the pair variable `a`, anchored in the way specified after the period.

```
top
lft rt
bot
```

The command `dotlabel` also typesets the point as a rather visible dot.

```
pair a ; a := (3cm,3cm) ;
dotlabel.top("top",a) ; dotlabel.bot("bot",a) ;
dotlabel.lft("lft",a) ; dotlabel.rt ("rt" ,a) ;

top
lft•rt
bot
```

The command `thelabel` returns the typeset label as picture that you can manipulate or draw afterwards.

```
pair a ; a := (3cm,3cm) ; pickup pencircle scaled 1mm ;
drawdot a withcolor .625yellow ;
draw thelabel.rt("the right way",a) withcolor .625red ;
```

You can of course rotate, slant and manipulate such a label picture like any other picture.

•the right way

The font can be specified in the string `defaultfont` and the scale in `defaultscale`. Labels are defined using the low level operator `infont`. The next statement returns a picture:

```
draw "this string will become a sequence of glyphs (MP)"
infont defaultfont scaled defaultscale ;
```

By default the `infont` operator is not that clever and does not apply kerning. Also, typesetting math or accented characters are not supported. The way out of this problem is using `btex ... etex`.

```
draw btex this string will become a sequence of glyphs (\TeX) etex ;
```

The difference between those two methods is shown below. The outcome of `infont` depends on the current setting of the variable `defaultfont`.

```
this string will become a sequence of glyphs (MP)
this string will become a sequence of glyphs (TEX)
```

When you run inside `CONTEXT` (as we do here) there is no difference between `infont` and the `TEX` methods. This is because we overload the `infont` operator and also pass its content to `TEX`. Both `infont` and `btex` use the macro `texttext` which is intercepted and redirects the task to `TEX`. This happens in the current run so there is no need to pass extra information about fonts.

Instead of passing strings to `infont`, you can also pass characters, using `char`, for example `char(73)`. When you use `infont` you normally expect the font to be ASCII conforming. If this is not the case, you must make sure that the encoding of the font that you use matches your expectations. However, as we overload this macro it does not really matter since the string is passed to `TEX` anyway. For instance, UTF encoded text should work fine as `CONTEXT` itself understands this encoding.

1.16 Linear equations

In the previous sections, we used the assignment operator `:=` to assign a value to a variable. Although for most of the graphics that we will present in later chapters, an assignment is appropriate, specifying a graphic in terms of expressions is not only more flexible, but also more in the spirit of the designers of `METAFONT` and `METAPOST`.

The METAFONT book and METAPOST manual provide lots of examples, some of which involve math that we don't consider to belong to everyone's repertoire. But, even for non-mathematicians using expressions can be a rewarding challenge.

The next introduction to linear equations is based on my first experiences with METAPOST and involves a mathematical challenge posed by a friend. I quickly ascertained that a graphical proof was far more easy than some proof with a lot of $\sin(\textit{this})$ and $\cos(\textit{that})$ and long forgotten formulas.

I was expected to prove that the lines connecting the centers of four squares drawn upon the four sides of a quadrilateral were perpendicular (see figure 1.4).

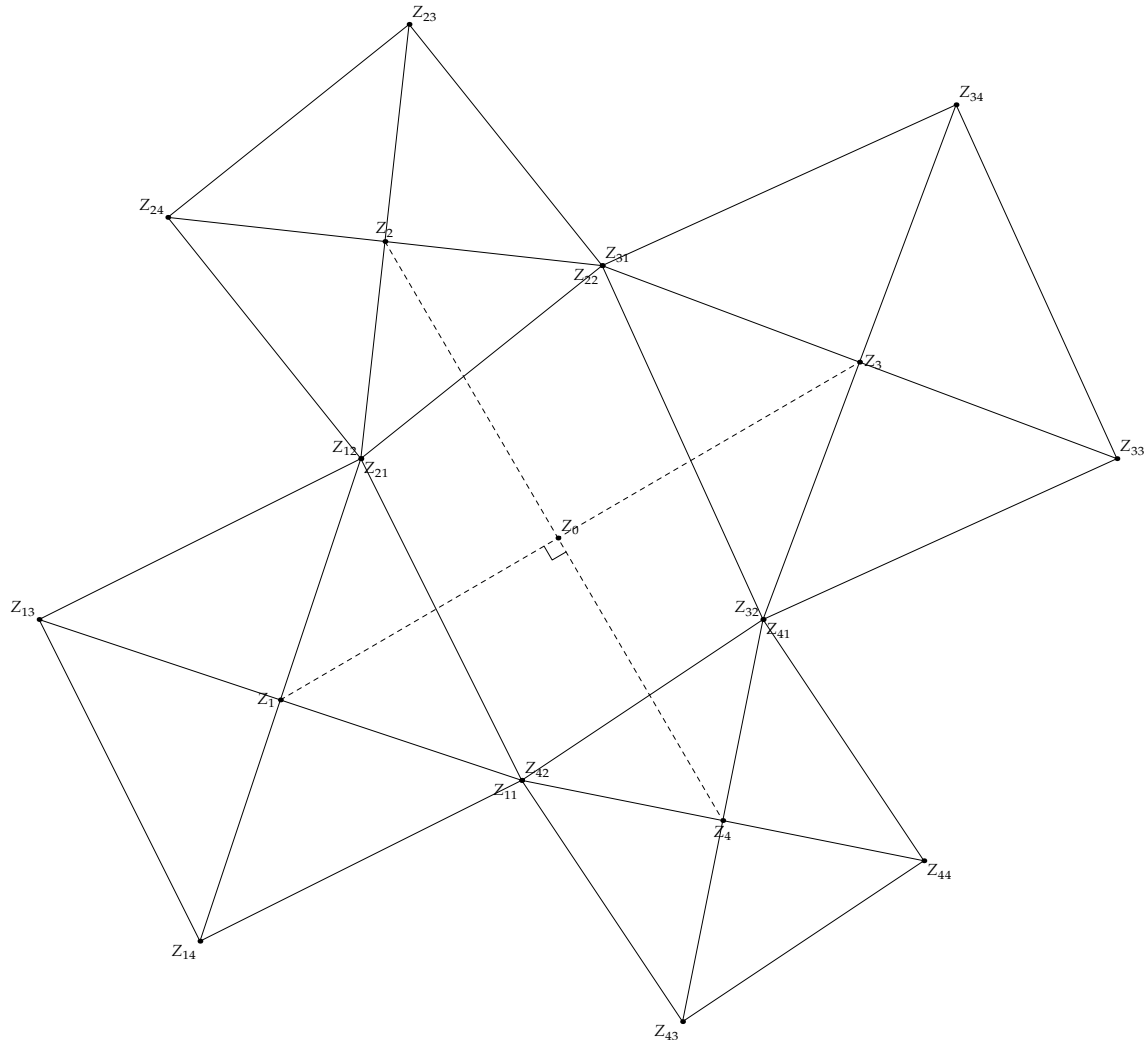

Figure 1.4 The problem.

This graphic was generated with the following command:

```
\placefigure
[here] [fig:problem]
{The problem.}
{\scale
[width=\textwidth]
```

```
{\useMPgraphic{solvers::one}{i=0.6,j=1.0,s=1}}
```

We will use this example to introduce a few new concepts, one being instances. In a large document there can be many METAPOST graphics and they might fall in different categories. In this manual we have graphics that are generated as part of the style as well as examples that show what METAFUN can do. As definitions and variables in METAPOST are global by default, there is a possibility that we end up with clashes. This can be avoided by grouping graphics in instances. Here we create an instance for the example that we're about to show.

```
\defineMPinstance
[solvers]
[format=metafun,
extensions=yes,
initializations=yes]
```

We can now limit the scope of definitions to this specific instance. Let's start with the macro that takes care of drawing the solution to our problem. The macro accepts four pairs of coordinates that determine the central quadrilateral. All of them are expressions.

```
\startMPdefinitions[solvers]
def draw_problem (expr p, q, r, s, show_labels) =
  begingroup ; save x, y, a, b, c, d, e, f, g, h ;

  z11 = z42 = p ; z21 = z12 = q ; z31 = z22 = r ; z41 = z32 = s ;

  a = x12 - x11 ; b = y12 - y11 ; c = x22 - x21 ; d = y22 - y21 ;
  e = x32 - x31 ; f = y32 - y31 ; g = x42 - x41 ; h = y42 - y41 ;

  z11 = (x11, y11) ; z12 = (x12, y12) ;
  z13 = (x12-b, y12+a) ; z14 = (x11-b, y11+a) ;
  z21 = (x21, y21) ; z22 = (x22, y22) ;
  z23 = (x22-d, y22+c) ; z24 = (x21-d, y21+c) ;
  z31 = (x31, y31) ; z32 = (x32, y32) ;
  z33 = (x32-f, y32+e) ; z34 = (x31-f, y31+e) ;
  z41 = (x41, y41) ; z42 = (x42, y42) ;
  z43 = (x42-h, y42+g) ; z44 = (x41-h, y41+g) ;

  pickup pencircle scaled .5pt ;

  draw z11--z12--z13--z14--cycle ; draw z11--z13 ; draw z12--z14 ;
  draw z21--z22--z23--z24--cycle ; draw z21--z23 ; draw z22--z24 ;
  draw z31--z32--z33--z34--cycle ; draw z31--z33 ; draw z32--z34 ;
  draw z41--z42--z43--z44--cycle ; draw z41--z43 ; draw z42--z44 ;

  z1 = 0.5[z11,z13] ; z2 = 0.5[z21,z23] ;
  z3 = 0.5[z31,z33] ; z4 = 0.5[z41,z43] ;

  draw z1--z3 dashed evenly ; draw z2--z4 dashed evenly ;

  z0 = whatever[z1,z3] = whatever[z2,z4] ;
  mark_rt_angle (z1, z0, z2) ; % z2 is not used at all

  if show_labels > 0 :
    draw_problem_labels ;
  fi ;
```

```

    endgroup ;
  enddef ;
\stopMPdefinitions

```

Because we want to call this macro more than once, we first have to save the locally used values. Instead of declaring local variables, one can hide their use from the outside world. In most cases variables behave globally. If we don't save them, subsequent calls will lead to errors due to conflicting equations. We can omit the grouping commands, because we wrap the graphic in a figure, and figures are grouped already.

We will use the predefined z variable, or actually a macro that returns a variable. This variable has two components, an x and y coordinate. So, we don't save z , but the related variables x and y .

Next we draw four squares and instead of hard coding their corner points, we use METAPOST's equation solver. Watch the use of $=$ which means that we just state dependencies. In languages like PERL, the equal sign is used in assignments, but in METAPOST it is used to express relations.

In a first version, we will just name a lot of simple relations, as we can read them from a sketch drawn on paper. So, we end up with quite some z related expressions.

For those interested in the mathematics behind this code, we add a short explanation. Absolutely key to the construction is the fact that you traverse the original quadrilateral in a clockwise orientation. What is really going on here is vector geometry. You calculate the vector from z_{11} to z_{12} (the first side of the original quadrilateral) with:

$$(a,b) = z_{12} - z_{11} ;$$

This gives a vector that points from z_{11} to z_{12} . Now, how about an image that shows that the vector $(-b,a)$ is a 90 degree rotation in the counterclockwise direction. Thus, the points z_{13} and z_{14} are easily calculated with vector addition.

$$\begin{aligned} z_{13} &= z_{12} + (-b,a) ; \\ z_{14} &= z_{11} + (-b,a) ; \end{aligned}$$

This pattern continues as you move around the original quadrilateral in a clockwise manner.³

The code that calculates the pairs a through h , can be written in a more compact way.

$$\begin{aligned} (a,b) &= z_{12} - z_{11} ; (c,d) = z_{22} - z_{21} ; \\ (e,f) &= z_{32} - z_{31} ; (g,h) = z_{42} - z_{41} ; \end{aligned}$$

The centers of each square can also be calculated by METAPOST. The next lines define that those points are positioned halfway the extremes.

$$\begin{aligned} z_1 &= 0.5[z_{11},z_{13}] ; z_2 = 0.5[z_{21},z_{23}] ; \\ z_3 &= 0.5[z_{31},z_{33}] ; z_4 = 0.5[z_{41},z_{43}] ; \end{aligned}$$

Once we have defined the relations we can let METAPOST solve the equations. This is triggered when a variable is needed, for instance when we draw the squares and their diagonals. We connect the centers of the squares using a dashed line style.

Just to be complete, we add a symbol that marks the right angle. First we determine the common point of the two lines, that lays at *whatever* point METAPOST finds suitable.

³ Thanks to David Arnold for this bonus explanation.

The definition of `mark_rt_angle` is copied from the METAPOST manual and shows how compact a definition can be (see page 13 for an introduction to `zscaled`).

```
\startMPdefinitions{solvers}
angle_radius := 10pt ;

def mark_rt_angle (expr a, b, c) =
  draw ((1,0)--(1,1)--(0,1))
    zscaled (angle_radius*unitvector(a-b))
    shifted b
enddef ;
\stopMPdefinitions
```

So far, most equations are rather simple, and in order to solve them, METAPOST did not have to work real hard. The only boundary condition is that in order to find a solution, METAPOST must be able to solve all dependencies.

The actual value of the `whatever` variable is that it saves us from introducing a slew of variables that will never be used again. We could write:

```
z0 = A[z1,z3] = B[z2,z4] ;
```

and get the same result, but the `whatever` variable saves us the trouble of introducing intermediate variables for which we have no use once the calculation is finished.

The macro `mark_rt_angle` draws the angle symbol and later we will see how it is defined. First we draw the labels. Unfortunately we cannot package `btex . . . etex` into a macro, because it is processed in a rather special way. Each `btex . . . etex` occurrence is filtered from the source and converted into a snippet of \TeX code. When passed through \TeX , each snippet becomes a page, and an auxiliary program converts each page into a METAPOST picture definition, which is loaded by METAPOST. The limitation lays in the fact that the filtering is done independent from the METAPOST run, which means that loops (and other code) are not seen at all. Later we will introduce the METAFUN way around this.

In order to get all the labels typeset, we have to put a lot of code here. The macro `dotlabel` draws a dot and places the typeset label.

```
\startMPdefinitions{solvers}
def draw_problem_labels =
  pickup pencircle scaled 5pt ;

  dotlabel.llft("$Z_{11}$", z11) ; dotlabel.ulft("$Z_{12}$", z12) ;
  dotlabel.ulft("$Z_{13}$", z13) ; dotlabel.llft("$Z_{14}$", z14) ;

  dotlabel.lrt (" $Z_{21}$", z21) ; dotlabel.llft("$Z_{22}$", z22) ;
  dotlabel.urt (" $Z_{23}$", z23) ; dotlabel.ulft("$Z_{24}$", z24) ;

  dotlabel.urt (" $Z_{31}$", z31) ; dotlabel.ulft("$Z_{32}$", z32) ;
  dotlabel.urt (" $Z_{33}$", z33) ; dotlabel.urt (" $Z_{34}$", z34) ;

  dotlabel.lrt (" $Z_{41}$", z41) ; dotlabel.urt (" $Z_{42}$", z42) ;
  dotlabel.llft("$Z_{43}$", z43) ; dotlabel.lrt (" $Z_{44}$", z44) ;

  dotlabel.urt (" $Z_{0}$", z0) ;
  dotlabel.lft (" $Z_{1}$", z1) ; dotlabel.top (" $Z_{2}$", z2) ;
  dotlabel.rtl (" $Z_{3}$", z3) ; dotlabel.bot (" $Z_{4}$", z4) ;
```



```

enddef ;
\stopMPdefinitions

```

Watch out: as we are in `CONTEXT`, we can pass regular `TEX` code to the label macro. In a standalone `METAPOST` run you'd have to use the `btex` variant.

We are going to draw a lot of pictures, so we define an extra macro. This time we hard-code some values. The fractions `i` and `j` are responsible for the visual iteration process, while `s` determines the labels. We pass these variables to the graphic using an extra argument. When you define the (useable) graphic you need to tell what variables it can expect.

```

\startuseMPgraphic{solvers::one}{i,j,s}
  draw_problem (
    (400pt,400pt), (300pt,600pt),
    \MPvar{i}[(300pt,600pt), (550pt,800pt)],
    \MPvar{j}[(400pt,400pt), (550pt,500pt)],
    \MPvar{s}
  ) ;
\stopuseMPgraphic

```

Of course we could have used a loop construct here, but defining auxiliary macros probably takes more time than simply calling the drawing macro directly. The results are shown on a separate page (figure 1.5).

We will use a helper macro (that saves us typing):

```

\def\MyTest#1#2%
  {\scale
    [width=.25\textwidth]
    {\useMPgraphic{solvers::one}{i=#1,j=#2,s=0}}}

```

We now can say:

```

\startcombination[3*4]
  {\MyTest{1.0}{1.0}} {1.0 / 1.0} {\MyTest{0.8}{1.0}} {0.8 / 1.0}
  {\MyTest{0.6}{1.0}} {0.6 / 1.0} {\MyTest{0.4}{1.0}} {0.4 / 1.0}
  {\MyTest{0.2}{1.0}} {0.2 / 1.0} {\MyTest{0.0}{1.0}} {0.0 / 1.0}
  {\MyTest{0.0}{1.0}} {0.0 / 1.0} {\MyTest{0.0}{0.8}} {0.0 / 0.8}
  {\MyTest{0.0}{0.6}} {0.0 / 0.6} {\MyTest{0.0}{0.4}} {0.0 / 0.4}
  {\MyTest{0.0}{0.2}} {0.0 / 0.2} {\MyTest{0.0}{0.0}} {0.0 / 0.0}
\stopcombination

```

Watch how we pass the settings to the graphic definition using an extra argument. We force using the `solvers` instance by prefixing the name.

It does not need that much imagination to see the four sided problem converge to a three sided one, which itself converges to a two sided one. In the two sided alternative it's not that hard to prove that the angle is indeed 90 degrees.

As soon as you can see a clear pattern in some code, it's time to consider using loops. In the previous code, we used semi indexes, like 12 in `z12`. In this case 12 does reflect something related to square 1 and 2, but in reality the 12 is just twelve. This does not harm our expressions.

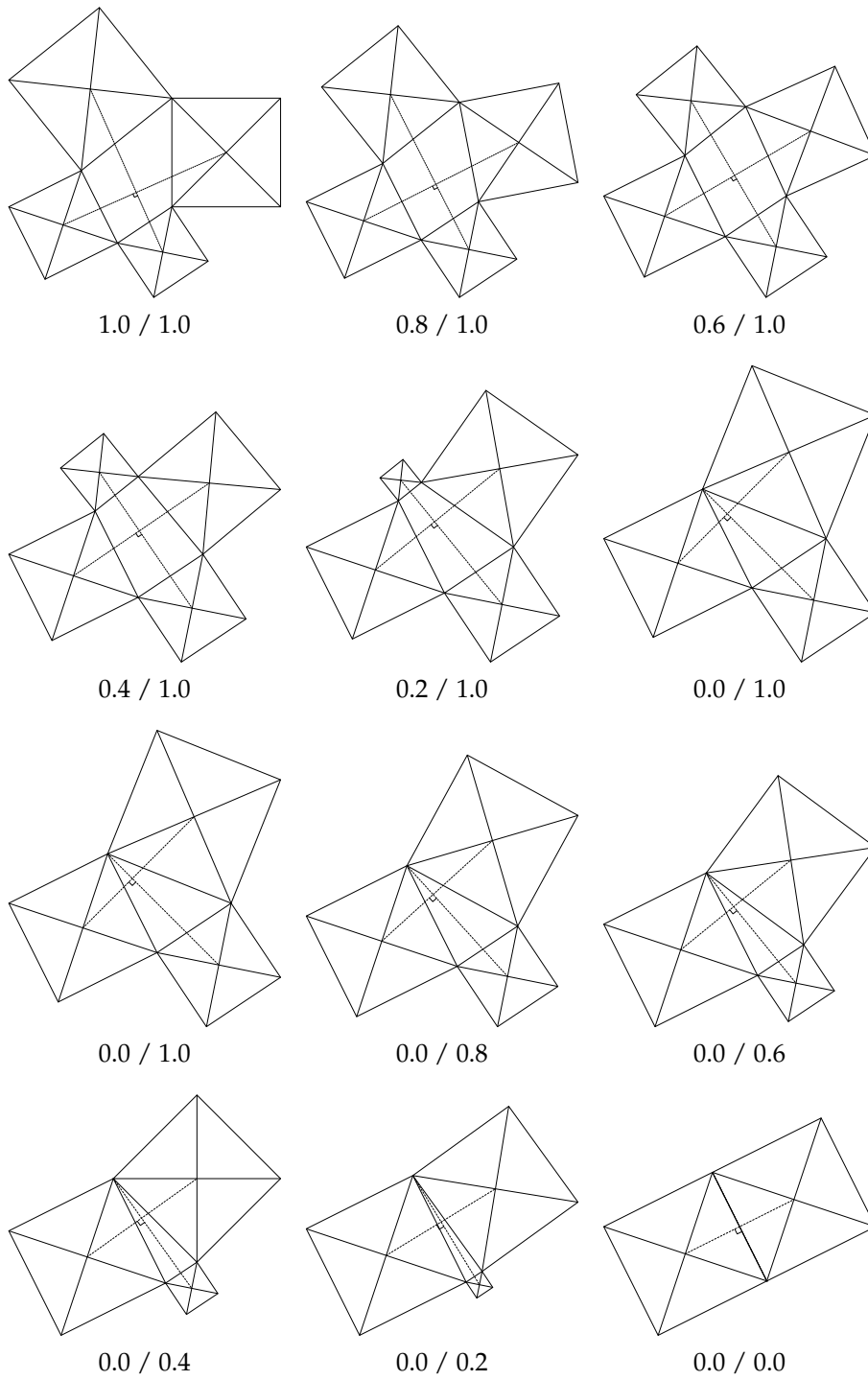

Figure 1.5 The solution.

A different approach is to use a two dimensional array. In doing so, we can access the variables more easily using loops. If we omit the labels, and angle macro, the previously defined macro can be reduced considerably.

```
def draw_problem (expr n, p, q, r, s) = % number and 4 positions
  begingroup ; save x, y ;

  z[1][1] = p ; z[2][1] = q ; z[3][1] = r ; z[4][1] = s ;

  for i=1 upto 4 :
    z[i][1] = (x[i][1],y[i][1]) = z[if i=1: 4 else: i-1 fi][2] ;
    z[i][2] = (x[i][2],y[i][2]) ;
    z[i][3] = (x[i][2]-y[i][2]+y[i][1], y[i][2]+x[i][2]-x[i][1]) ;
    z[i][4] = (x[i][1]-y[i][2]+y[i][1], y[i][1]+x[i][2]-x[i][1]) ;
    z[i] = 0.5[z[i][1],z[i][3]] ;
  endfor ;

  z[0] = whatever[z[1],z[3]] = whatever[z[2],z[4]] ;

  pickup pencircle scaled .5pt ;

  for i=1 upto 4 :
    draw z[i][1]--z[i][2]--z[i][3]--z[i][4]--cycle ;
    draw z[i][1]--z[i][3] ; draw z[i][2]--z[i][4] ;
    if i<3 : draw z[i]--z[i+2] dashed evenly fi ;
  endfor ;

  draw ((1,0)--(1,1)--(0,1))
    zscaled (unitvector(z[1]-z[0])*10pt)
    shifted z[0] ;

  endgroup ;
enddef ;
```

I think that we could argue quite some time about the readability of this code. If you start from a sketch, and the series of equations does a good job, there is hardly any need for such improvements to the code. On the other hand, there are situations where the simplified (reduced) case can be extended more easily, for instance to handle 10 points instead of 4. It all depends on how you want to spend your free hours.

1.17 Clipping

For applications that do something with a drawing, for instance \TeX embedding a graphic in a text flow, it is important to know the dimensions of the graphic. The maximum dimensions of a graphic are specified by its bounding box.

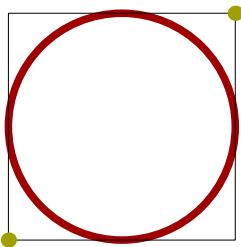

A bounding box is defined by its lower left and upper right corners. If you open the POSTSCRIPT file produced by METAPOST, you may find lines like:

```
%%BoundingBox: -46 -46 46 46
```

or, when supported,

```
%%HiResBoundingBox: -45.35432 -45.35432 45.35432 45.35432
```

The first two numbers define the lower left corner and the last two numbers the upper right corner. From these values, you can calculate the width and height of the graphic.

A graphic may extend beyond its bounding box. It depends on the application that uses the graphic whether that part of the graphic is shown.

In METAPOST you can ask for all four points of the bounding box of a path or picture as well as the center.

```
llcorner p  lower left corner
lrcorner p  lower right corner
urcorner p  upper right corner
ulcorner p  upper left corner
center p    the center point
```

You can construct the bounding box of path `p` out of the four points mentioned:

```
llcorner p -- lrcorner p -- urcorner p -- ulcorner p -- cycle
```

You can set the bounding box of a picture, which can be handy if you want to build a picture in steps and show the intermediate results using the same dimensions as the final picture, or when you want to show only a small piece.

```
fill fullcircle scaled 2cm withcolor .625yellow ;
setbounds currentpicture to unitsquare scaled 1cm ;
draw unitsquare scaled 1cm withcolor .625red ;
```

Here, we set the bounding box with the command `setbounds`, which takes a path.

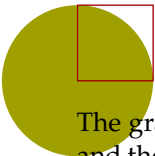

The graphic extends beyond the bounding box, but the bounding box determines the placement and therefore the spacing around the graphic. We can get rid of the artwork outside the bounding box by clipping it.

```
fill fullcircle scaled 2cm withcolor .625yellow ;
clip currentpicture to unitsquare scaled 1cm ;
```

The resulting picture is just as large but shows less of the picture.



1.18 Some extensions

We will now encounter a couple of transformations that can make your life easy when you use METAPOST for making graphics like the ones demonstrated in this document. These transformations are not part of standard METAPOST, but come with METAFUN.

A very handy extension is `enlarged`. Although you can feed it with any path, it will return a rectangle larger or smaller than the boundingbox of that path. You can specify a pair or a numeric.

```
path p ; p := fullsquare scaled 2cm ;
drawpath p ; drawpoints p ;
p := (p shifted (3cm,0)) enlarged (.5cm,.25cm) ;
drawpath p ; drawpoints p ;
```

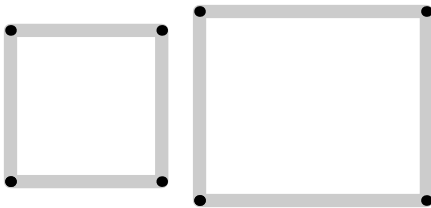

There are a few more alternatives, like `bottomenlarged`, `rightenlarged`, `topenlarged` and `leftenlarged`.

The `cornered` operator will replace sharp corners by rounded ones (we could not use `rounded` because this is already in use).

```
path p ; p := ((1,0)--(2,0)--(2,2)--(1,2)--(0,1)--cycle)
xysized (4cm,2cm) ;
drawpath p ; drawpoints p ;
p := (p shifted (5cm,0)) cornered .5cm ;
drawpath p ; drawpoints p ;
```

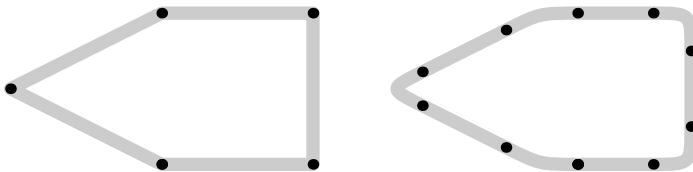

The `smoothed` operation is a less subtle one, since it operates on the bounding box and thereby can result in a different shape.

```
path p ; p := ((1,0)--(2,0)--(2,2)--cycle) xysized (4cm,2cm) ;
drawpath p ; drawpoints p ;
p := (p shifted (5cm,0)) smoothed .5cm ;
drawpath p ; drawpoints p ;
```

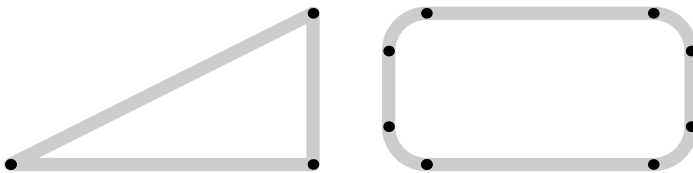

The next one, `simplified`, can be applied to paths that are constructed automatically. Instead of testing for duplicate points during construction, you can clean up the path afterwards.

```
path p ; p :=
  ((0,0)--(1,0)--(2,0)--(2,1)--(2,2)--(1,2)--(0,2)--(0,1)--cycle)
  xysize (4cm,2cm) ;
drawpath p ; drawpoints p ;
p := simplified (p shifted (5cm,0)) ;
drawpath p ; drawpoints p ;
```

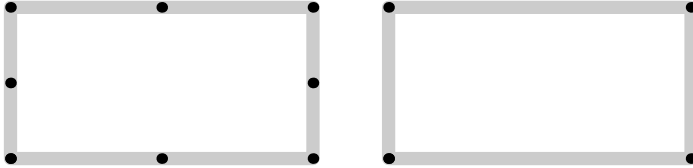

A cousin of the previous operation is `unspiked`. This one removes ugly left-overs. It works well for the average case.

```
path p ; p :=
  ((0,0)--(2,0)--(3,1)--(2,0)--(2,2)--(1,2)--(1,3)--(1,2)--(0,1)--cycle)
  xysize (4cm,2cm) ;
drawpath p ; drawpoints p ;
p := unspiked (p shifted (5cm,0)) ;
drawpath p ; drawpoints p ;
```

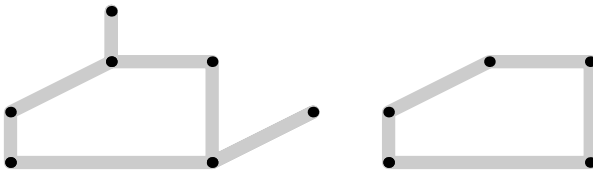

There are a couple of operations that manipulate the path in more drastic ways. Take `randomized`.

```
path p ; p := fullsquare scaled 2cm ;
drawpath p ; drawpoints p ;
p := (p shifted (5cm,0)) randomized .5cm ;
drawpath p ; drawpoints p ;
```



Or how about `squeezed`:

```
path p ; p := fullsquare scaled 2cm randomized .5cm ;
drawpath p ; drawpoints p ;
p := (p shifted (5cm,0)) squeezed .5cm ;
drawpath p ; drawpoints p ;
```



A punked path is, like a punked font, a font with less smooth curves (in our case, only straight lines).

```
path p ; p := fullcircle scaled 2cm randomized .5cm ;
drawpath p ; drawpoints p ;
p := punked (p shifted (5cm,0)) ;
drawpath p ; drawpoints p ;
```



A curved path on the other hand has smooth connections. Where in many cases a punked path becomes smaller, a curved path will be larger.

```
path p ; p := fullsquare scaled 2cm randomized .5cm ;
drawpath p ; drawpoints p ;
p := curved (p shifted (5cm,0)) ;
drawpath p ; drawpoints p ;
```

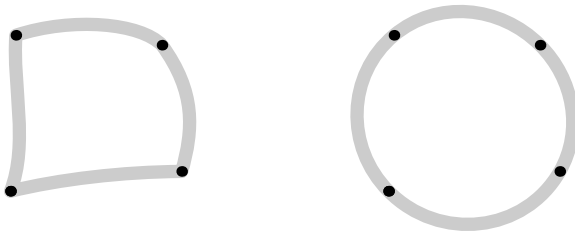

Probably less usefull (although we use it in one of the OPENTYPE visualizers) is laddered:

```
path p ; p := fullcircle scaled 3cm ;
drawpath p ; drawpoints p ;
p := laddered (p shifted (5cm,0)) ;
drawpath p ; drawpoints p ;
```

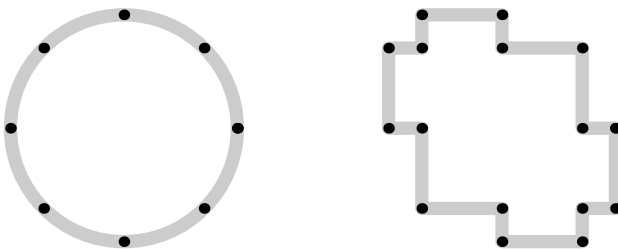

When writing `PPCHTeX` (that can be used to draw chemical structure formulas) I needed a parallelizing macro, so here it is:

```
path p ; p := fullcircle scaled 3cm ;
drawpath p ; drawpoints p ;
p := p paralleled 1cm ;
drawpath p ; drawpoints p ;
```

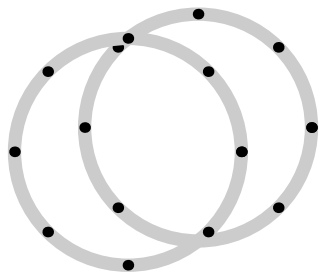

If you use a negative argument (like `-1cm`) the parallel line will be drawn at the other side.

The `blownup` operation scales the path but keeps the center in the same place.

```
path p ; p := fullsquare xyscaled (4cm,1cm) randomized .5cm ;
drawpath p ; drawpoints p ;
p := p blownup .5cm ;
drawpath p ; drawpoints p ;
```



The `shortened` operation also scales the path but only makes it longer or shorter. This macro only works on straight paths.

```
path p ; p := (0,0) -- (2cm,3cm) ;
drawpath p ; drawpoints p ;
p := p shortened 1cm ;
drawpath p ; drawpoints p ;
p := p shortened -1cm ;
drawpath p ; drawpoints p ;
```

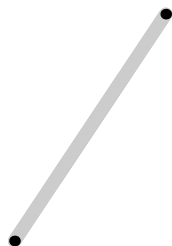

Here are a few more drawing helpers. Even if you don't need them you might at some point take a look at their definitions to see what happens there. First we give a square round corners with `roundsquare`:

```
path p ; p := roundedsquare(2cm,4cm,.25cm) ;
drawpath p ; drawpoints p ;
```

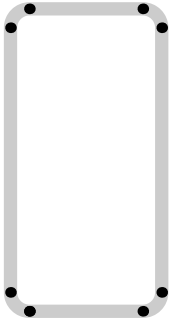

Next we draw a square-like circle (or circle-like square) using `tensecircle`:

```
path p ; p := tensecircle(2cm,4cm,.25cm) ;
drawpath p ; drawpoints p ;
```

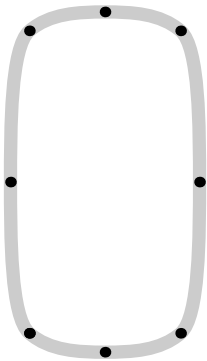

Often I make such helpers in the process of writing larger drawing systems. Take `crossed`:

```
path p ; p := origin crossed 1cm ;
drawpath p ; drawpoints p ;
p := (origin crossed fullcircle scaled 2cm crossed .5cm) shifted (3cm,0) ;
drawpath p ; drawpoints p ;
```

These examples demonstrate that a path is made up out of points (something that you probably already knew by now). The `METAPOST` operator `of` can be used to 'access' a certain point at a curve.

```
path p ; p := fullsquare xyscaled (3cm,2cm) randomized .5cm ;
drawpath p ; drawpoints p ; drawpointlabels p ;
draw point 2.25 of p withpen pencircle scaled 5mm withcolor .625red ;
```

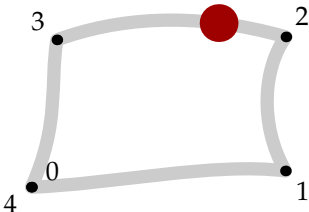

To this we add two more operators: `on` and `along`. With `on` you get the point at the supplied distance from point 0; with `along` you get the point at the fraction of the length of the path.

```
path p, q, r ;
p := fullsquare xyscaled (2cm,2cm) randomized .5cm ;
q := p shifted (3cm,0) ; r := q shifted (3cm,0) ;
drawpath p ; drawpoints p ; drawpointlabels p ;
drawpath q ; drawpoints q ; drawpointlabels q ;
drawpath r ; drawpoints r ; drawpointlabels r ;
pickup pencircle scaled 5mm ;
draw point 2.25 of p withcolor .625red ;
draw point 2.50cm on q withcolor .625yellow ;
draw point .45 along r withcolor .625white ;
```

Beware: the length of a path is the number of points minus one. The shapes below are constructed from 5 points and a length of 4. If you want the length as dimension, you should use `arclength`.

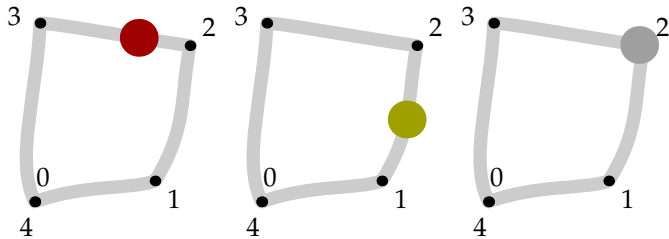

We will now play a bit with simple lines. With `cutends`, you can (indeed) cut off the ends of a curve. The specification is a dimension.

```
path p ; p := (0cm,0cm) -- (4cm,1cm) ;
path q ; q := (5cm,0cm){right} .. (9cm,1cm) ;
drawpath p ; drawpoints p ; drawpath q ; drawpoints q ;
p := p cutends .5cm ; q := q cutends .5cm ;
drawpathoptions (withpen pencircle scaled 5pt withcolor .625yellow) ;
drawpointoptions(withpen pencircle scaled 4pt withcolor .625red) ;
drawpath p ; drawpoints p ; drawpath q ; drawpoints q ;
resetdrawoptions ;
```

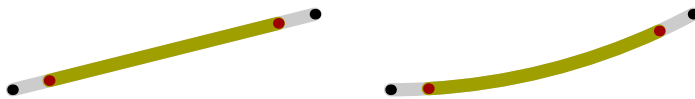

As with more operators, `cutends` accepts a numeric or a pair. Watch the subtle difference between the next and the previous use of `cutends`.

```
path p ; p := (0cm,0) .. (4cm,0) .. (8cm,0) .. (4cm,0) .. cycle ;
drawpath p ; drawpoints p ; p := p cutends (2cm,1cm) ;
drawpathoptions (withpen pencircle scaled 5pt withcolor .625yellow) ;
drawpointoptions(withpen pencircle scaled 4pt withcolor .625red) ;
drawpath p ; drawpoints p ;
resetdrawoptions ;
```

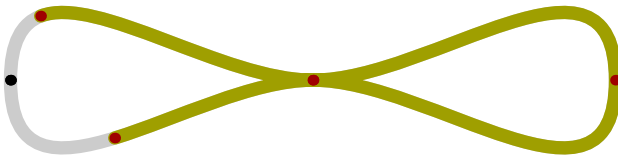

When stretched is applied to a path, it is scaled but the starting point (point 0) keeps its location. The specification is a scale.

```
path p ; p := (0cm,0) .. (3cm,1cm) .. (4cm,0) .. (5cm,1cm) ;
drawpath p ; drawpoints p ; p := p stretched 1.1 ;
drawpathoptions (withpen pencircle scaled 2.5pt withcolor .625yellow) ;
drawpointoptions(withpen pencircle scaled 4.0pt withcolor .625red) ;
drawpath p ; drawpoints p ; resetdrawoptions ;
```

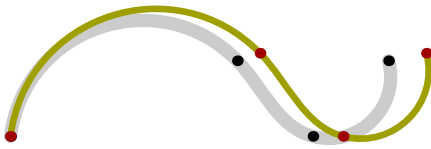

We can scale in two directions independently or even in one direction by providing a zero value. In the next example we apply the stretch two times.

```
path p ; p := (0cm,0) .. (3cm,1cm) .. (4cm,0) .. (5cm,1cm) ;
drawpath p ; drawpoints p ; p := p stretched (.75,1.25) ;
drawpathoptions (withpen pencircle scaled 2.5pt withcolor .625yellow) ;
drawpointoptions(withpen pencircle scaled 4.0pt withcolor .625red) ;
drawpath p ; drawpoints p ; p := p stretched (0,1.5) ;
drawpathoptions (withpen pencircle scaled 4.0pt withcolor .625red) ;
drawpointoptions(withpen pencircle scaled 2.5pt withcolor .625yellow) ;
drawpath p ; drawpoints p ; resetdrawoptions ;
```

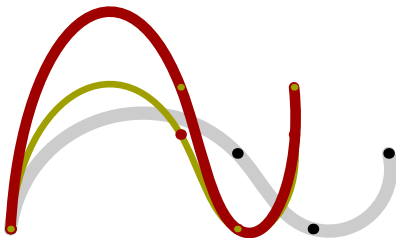

We already met the randomize operator. This one is the chameleon under the operators.

```
draw fullsquare xyscaled (4cm,2cm)
  randomized .25cm
  shifted origin randomized (1cm, 2cm)
  withcolor red randomized (.625, .850)
  withpen pencircle scaled (5pt randomized 1pt) ;
```

So, randomized can handle a numeric, pair, path and color, and its specification can be a numeric, pair or color, depending on what we're dealing with.

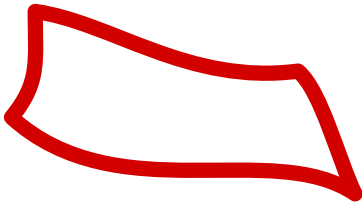

In the previous example we also see `xyscaled` in action. Opposite to `scaled`, `xscaled` and `yscaled`, this is not one of METAPOST build in features. The same is true for the `.sized` operators.

```

picture p ; p := image
  ( draw fullsquare
    xyscaled (300,800)
    withpen pencircle scaled 50
    withcolor .625 yellow ; ) ;
draw p xysized (3cm,2cm) shifted (bbwidth(currentpicture)+.5cm,0) ;
draw p xysized 2cm shifted (bbwidth(currentpicture)+.5cm,0) ;
draw p xsized 1cm shifted (bbwidth(currentpicture)+.5cm,0) ;
draw p ysize 2cm shifted (bbwidth(currentpicture)+.5cm,0) ;

```

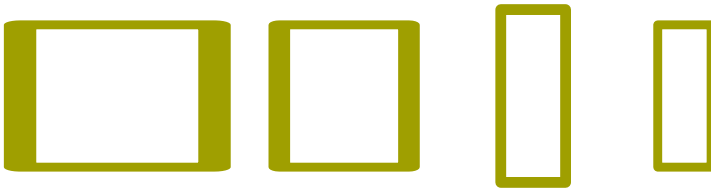

Here, the `image` macro creates an (actually rather large) picture. The last four lines actually draw this picture, but at the given dimensions. Watch how the line width scales accordingly. If you don't want this, you can add the following line:

```

redraw currentpicture withpen pencircle scaled 2pt ;
draw boundingbox currentpicture withpen pencircle scaled .5mm ;

```

Watch how the boundingbox is not affected:

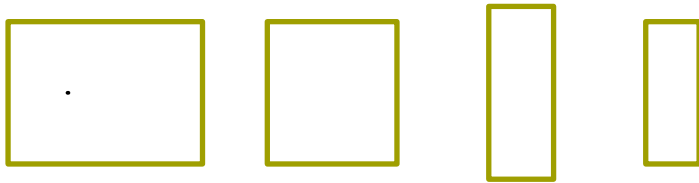

In this example we also used `bbwidth` (which has a companion macro `bbheight`). You can apply this macro to a path or a picture.

In fact you don't always need to follow this complex route if you want to simply redraw a path with another pen or color.

```

draw fullcircle scaled 1cm
  withcolor .625red withpen pencircle scaled 1mm ;
draw currentpicture
  withcolor .625yellow withpen pencircle scaled 3mm ;
draw boundingbox currentpicture

```

```
withpen pencircle scaled .5mm ;
```

This is what you will get from this:



If you want to add a background color to a picture you can do that afterwards. This can be handy when you don't know in advance what size the picture will have.

```
fill fullcircle scaled 1cm withcolor .625red ;
addbackground withcolor .625 yellow ;
```

The background is just a filled rectangle that gets the same size as the current picture, that is put on top of it.



1.19 Cutting and pasting

When enhancing or building a graphic, often parts of already constructed paths are needed. The `subpath`, `cutbefore` and `cutafter` operators can be used to split paths in smaller pieces. In order to do so, we must know where we are on the path that is involved. For this we use points on the path. Unfortunately we can only use these points when we know where they are located. In this section we will combine some techniques discussed in previous sections. We will define a few macros, manipulate some paths and draw curves and points.

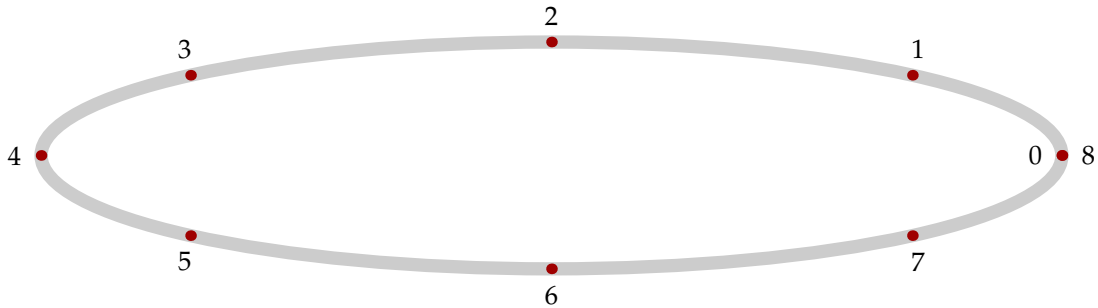

This circle is drawn by scaling the predefined path `fullcircle`. This path is constructed using 8 points. As you can see, these points are not distributed equally along the path. In the following graphic, the second and third point of the curve are colored red, and point 2.5 is colored yellow. Point 0 is marked in black. This point is positioned halfway between point 2 and 3.

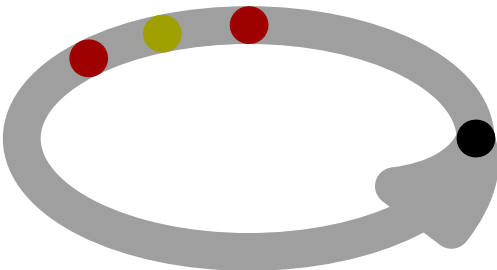

It is clear that, unless you know exactly how the path is constructed, other methods should be available. A specific point on a path is accessed by `point ... of`, but the next example demonstrates two more alternatives.

```
path p ; p := fullcircle scaled 3cm xscaled 2 ;
pickup pencircle scaled 5mm ;
draw p withcolor .625white ;
draw point 3 of p withcolor .625red ;
draw point .6 along p withcolor .625yellow ;
draw point 3cm on p ;
```

So, in addition to `on` to specify a point by number (in METAPOST terminology called time), we have `along` to specify a point as fraction of the path, and `on` to specify the position in a dimension.

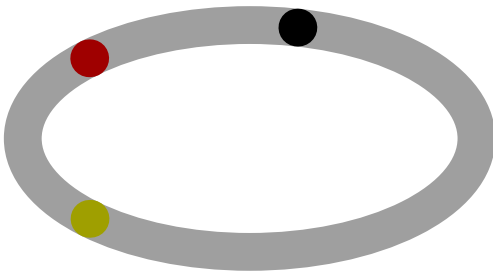

The `on` and `along` operators are macros and can be defined as:

```
primarydef len on pat =
  (arctime len of pat) of pat
enddef ;

primarydef pct along pat =
  (arctime (pct * (arclength pat)) of pat) of pat
enddef ;
```

These macros introduce two new primitives, `arctime` and `arclength`. While `arctime` returns a number denoting the time of the point on the path, `arclength` returns a dimension.

“When mathematicians draw parametric curves, they frequently need to indicate the direction of motion. I often have need of a little macro that will put an arrow of requested length, anchored at a point on the curve, and bending with the curve in the direction of motion.”

When David Arnold asked me how this could be achieved, the fact that a length was requested meant that the solution should be sought in using the primitives and macros we introduced a few paragraphs before. Say that we want to call for such an arrow as follows.

```
path p ; p := fullcircle scaled 3cm ;
pair q ; q := point .4 along p ;
pickup pencircle scaled 2mm ;
draw p withcolor .625white ;
drawarrow somearrow(p,q,2cm) withcolor .625red ;
draw q withcolor .625yellow ;
```

Because we want to follow the path, we need to construct the arrow from this path. Therefore, we first reduce the path by cutting off the part before the given point. Next we cut off the end of the

resulting path so that we keep a slice that has the length that was asked for. Since we can only cut at points, we determine this point using the `arctime` primitive.

```
vardef somearrow (expr pat, loc, len) =
  save p ; path p ; p := pat cutbefore loc ;
  (p cutafter point (arctime len of p) of p)
enddef ;
```

By using a `vardef` we hide the intermediate assignments. Such `vardef` is automatically surrounded by `begingroup` and `endgroup`, so the `save` is local to this macro. When processed, this code produces the following graphic:

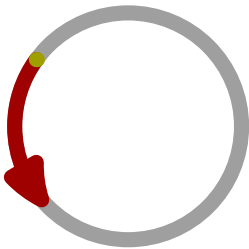

This graphic shows that we need a bit more control over the exact position of the arrow. It would be nice if we could start the arrow at the point, or end there, or center the arrow around the point. Therefore, the real implementation is a bit more advanced.

```
vardef pointarrow (expr pat, loc, len, off) =
  save l, r, s, t ; path l, r ; numeric s ; pair t ;
  t := if pair loc : loc else : point loc along pat fi ;
  s := len/2 - off ; if s<=0 : s := 0 elseif s>len : s := len fi ;
  r := pat cutbefore t ;
  r := (r cutafter point (arctime s of r) of r) ;
  s := len/2 + off ; if s<=0 : s := 0 elseif s>len : s := len fi ;
  l := reverse (pat cutafter t) ;
  l := (reverse (l cutafter point (arctime s of l) of l)) ;
  (l..r)
enddef ;
```

This code fragment also demonstrates how we can treat the `loc` argument as pair (coordinates) or fraction of the path. We calculate the piece of path before and after the given point separately and paste them afterwards as `(l..r)`. By adding braces we can manipulate the path in expressions without the danger of handling `r` alone.

We can now implement left, center and right arrows by providing this macro the right parameters. The offset (the fourth parameter), is responsible for a backward displacement. This may seem strange, but negative values would be even more confusing.

```
def rightarrow (expr p,t,l) = pointarrow(p,t,l,-l) enddef ;
def leftarrow  (expr p,t,l) = pointarrow(p,t,l,+l) enddef ;
def centerarrow(expr p,t,l) = pointarrow(p,t,l, 0) enddef ;
```

We can now apply this macro as follows:

```
path p ; p := fullcircle scaled 3cm ;
```

```

pickup pencircle scaled 2mm ;
draw p withcolor .625white ;
drawarrow leftarrow (p, .4 ,2cm) withcolor .625red ;
drawarrow centerarrow(p,point 5 of p,2cm) withcolor .625yellow ;
draw point .4 along p withcolor .625yellow ;
draw point 5 of p withcolor .625red ;

```

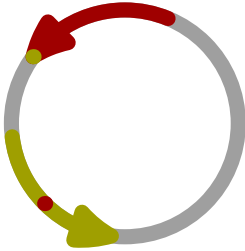

Watch how we can pass a point (point 5 of p) as well as a fraction (.4). The following graphic demonstrates a few more alternatives.

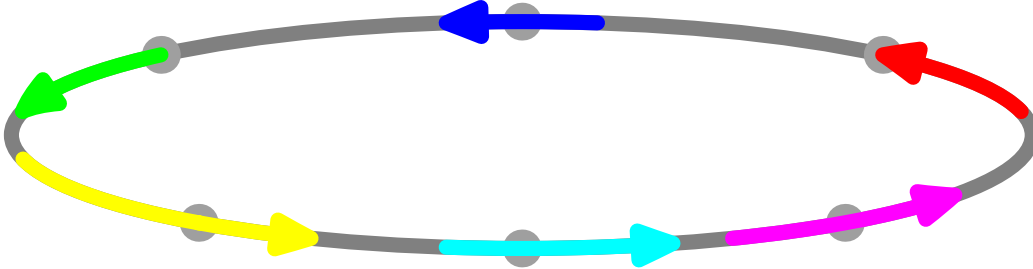

The arrows are drawn using the previously defined macros. Watch the positive and negative offsets in call to pointarrow.

```

drawarrow leftarrow (p,point 1 of p,2cm) withcolor red ;
drawarrow centerarrow (p,point 2 of p,2cm) withcolor blue ;
drawarrow rightarrow (p,point 3 of p,2cm) withcolor green ;
drawarrow pointarrow (p,.60,4cm,+ .5cm) withcolor yellow ;
drawarrow pointarrow (p,.75,3cm,- .5cm) withcolor cyan ;
drawarrow centerarrow (p,.90,3cm) withcolor magenta ;

```

1.20 Current picture

When you draw paths, texts and/or pictures they are added to the so called current picture. You can manipulate this current picture as is demonstrated in this manual. Let's show a few current picture related tricks.

```

draw fullcircle scaled 1cm withpen pencircle scaled 1mm withcolor .625red ;

```



We can manipulate the picture as a whole:

```

draw fullcircle scaled 1cm withpen pencircle scaled 1mm withcolor .625red ;

```



```
currentpicture := currentpicture slanted .5 ;
```



Sometimes it's handy to temporarily set aside the current picture.

```
draw fullcircle scaled 1cm withpen pencircle scaled 1mm withcolor .625red ;
currentpicture := currentpicture slanted .5 ;
pushcurrentpicture ;
draw fullcircle scaled 1cm withpen pencircle scaled 1mm withcolor .625yellow ;
currentpicture := currentpicture slanted -.5 ;
popcurrentpicture ;
```



These are METAFUN commands but METAPOST itself comes with a variant, `image`, and you explicitly have to draw this picture (or otherwise add it to the `currentpicture`).

```
draw fullcircle scaled 1cm withpen pencircle scaled 1mm withcolor .625red ;
currentpicture := currentpicture slanted .5 ;
draw image (
  draw fullcircle scaled 1cm
    withpen pencircle scaled 1mm withcolor .625yellow ;
  currentpicture := currentpicture slanted -.5 ;
) ;
```



Each graphic starts fresh with an empty current picture. In METAFUN we make sure that we also reset some otherwise global variables, like `color`, `pen` and some line properties.

2 A few more details

In this chapter we will see how to define a METAPOST graphic, and how to include it in a document. Since the exact dimensions of graphics play an important role in the placement of a graphic, we will explore the way a bounding box is constructed.

We will also pay attention to the usage of units and the side effects of scaling and shifting, since they can contradict our expectations in unexpected ways. Furthermore we will explore a few obscure areas.

2.1 Making graphics

In this manual we will use METAPOST in a rather straightforward way, and we will try to avoid complicated math as much as possible. We will do a bit of drawing, clipping, and moving around. Occasionally we will see some more complicated manipulations.

When defined as stand-alone graphic, a METAPOST file looks like this:

```
% Let's draw a circle.

beginfig (7) ;
  draw fullcircle scaled 3cm withpen pencircle scaled 1cm ;
endfig ;

end .
```

The main structuring components in such a file are the `beginfig` and `endfig` macros. Like in a big story, the file has many sub-sentences, where each sub-sentence ends with a semi-colon. Although the `end` command at the end of the file concludes the story, putting a period there is a finishing touch. Actually, after the `end` command you can put whatever text you wish, your comments, your grocery list, whatever. Comments in METAPOST, prefixed by a percent sign, as in `% Let's draw a circle`, are ignored by the interpreter, but useful reminders for the programmer.

If the file is saved as `yourfile.mp`, then the file is processed by METAPOST by issuing the following command:

```
mpost yourfile
```

after which you will have a graphic called `yourfile.7`, which contains a series of POSTSCRIPT commands. Because METAPOST does all the work, this file is efficient and compact. The number of distinct POSTSCRIPT operators used is limited, which has the advantage that we can postprocess this file rather easily. Alternatively METAPOST can generate SVG output. It does when you say

```
outputformat := "svg" ;
```

Here we will not go into details about this format. Even POSTSCRIPT is not covered in detail as we use METAPOST mostly in embedded form.

We can view this file in a POSTSCRIPT viewer like GHOSTVIEW or convert the graphic to PDF (using `mptopdf`) and view the result in a suitable PDF viewer like ACROBAT. Of course, you can embed such a file in a CONTEXT document, using a command like:

```
\externalfigure[yourfile.7]
```

We will go in more detail about embedding graphics in chapter 3.

If you have installed `CONTEXT`, somewhere on your system there resides a file `mp-tool.mp`. If you make a stand-alone graphic, it's best to put the following line at the top of your file:

```
input mp-tool ; % or input metafun ;
```

By loading this file, the resulting graphic will provide a high resolution bounding box, which enables more accurate placement. The file also sets the prologues `:= 1` so that viewers like `GHOSTVIEW` can refresh the file when it is changed.

Next we will introduce some more `METAPOST` commands. From now on, we will omit the encapsulating `beginfig` and `endfig` macros. If you want to process these examples yourself, you should add those commands yourself, or if you use `CONTEXT` you don't need them at all.

```
pickup pencircle scaled .5cm ;
draw unitsquare xscaled 8cm yscaled 1cm withcolor .625white ;
draw origin withcolor .625yellow ;
pickup pencircle scaled 1pt ;
draw bbox currentpicture withcolor .625red ;
```

In this example we see a mixture of so called primitives as well as macros. A primitive is something hard coded, a built-in command, while a macro is a collection of such primitives, packaged in a way that they can be recalled easily. Where `scaled` is a primitive and `draw` a macro, `unitsquare` is a path variable, an abbreviation for:

```
unitsquare = (0,0) -- (1,0) -- (1,1) -- (0,1) -- cycle ;
```

The double dash (`--`) is also a macro, used to connect two points with a straight line segment. However, `cycle` is a primitive, which connects the last point of the `unitsquare` to the first on `unitsquare`'s path. Path variables must first be declared, as in:

```
path unitsquare ;
```

A large collection of such macros is available when you launch `METAPOST`. Consult the `METAPOST` manual for details.



In the first line of our example, we set the drawing pen to `.5cm`. You can also specify such a dimension in other units, like points (`pt`). When no unit is provided, `METAPOST` will use a big point (`bp`), the `POSTSCRIPT` approximation of a point.

The second line does just as it says: it draws a rectangle of certain dimensions in a certain color. In the third line we draw a colored dot at the origin of the coordinate system in which we are drawing. Finally, we set up a smaller pen and draw the bounding box of the current picture, using the variable `currentpicture`. Normally, all drawn shapes end up in this picture variable.

2.2 Bounding boxes

If you take a close look at the last picture in the previous section, you will notice that the bounding box is larger than the picture. This is one of the nasty side effects of `METAPOST`'s `bbox` macro. This macro draws a box, but with a certain offset. The next example shows how we can manipulate

this offset. Personally I never use the `bbox` macro because this offset is rather annoying. Also, the `boundingbox` operator combined with `enlarged` can provide any offset you want.

```
pickup pencircle scaled .5cm ;
draw unitsquare xscaled 8cm yscaled 1cm withcolor .625white ;
path bb ; bboxmargin := 0pt ; bb := bbox currentpicture ;
draw bb withpen pencircle scaled 1pt withcolor .625red ;
draw origin withpen pencircle scaled 5pt withcolor .625yellow ;
```

In the third line we define a path variable. We assign the current bounding box to this variable, but first we set the offset to zero. The last line demonstrates how to draw such a path. Instead of setting the pen as we did in the first line, we pass the dimensions directly.



Where `draw` draws a path, the `fill` macro fills one. In order to be filled, a path should be closed, which is accomplished by the `cycle` primitive, as we saw in constructing the `unitsquare` path.

```
pickup pencircle scaled .5cm ;
fill unitsquare xscaled 8cm yscaled 1cm withcolor .625white ;
path bb ; bboxmargin := 0pt ; bb := bbox currentpicture ;
draw bb withpen pencircle scaled 1pt withcolor .625red ;
draw origin withpen pencircle scaled 5pt withcolor .625yellow ;
```

This example demonstrates that when we fill the path, the resulting graphic is smaller. Where `draw` follows the center of a path, `fill` stays inside the path.



A third alternative is the `filldraw` macro. From the previous examples, we would expect a bounding box that matches the one of the drawn path.

```
pickup pencircle scaled .5cm ;
filldraw unitsquare xscaled 8cm yscaled 1cm withcolor .625white ;
path bb ; bboxmargin := 0pt ; bb := bbox currentpicture ;
draw bb withpen pencircle scaled 1pt withcolor .625red ;
draw origin withpen pencircle scaled 5pt withcolor .625yellow ;
```

The resulting graphic has the bounding box of the fill. Note how the path, because it is stroked with a `.5cm` pen, extends beyond the border of the previous bounding box. The way this image shows up depends on the viewer (settings) you use to render the graphic. For example, in `GHOSTVIEW`, if you disable clipping to the bounding box, only the positive quadrant of the graphic is shown.⁴



⁴ Old versions of `METAPOST` calculated the boundingbox differently for a `filldraw`: through the middle of the penpath.

From the previous examples, you can conclude that the following alternative results in a proper bounding box:

```
pickup pencircle scaled .5cm ;
path p ; p := unitsquare xscaled 8cm yscaled 1cm ;
fill p withcolor .625white ;
draw p withcolor .625white ;
path bb ; bboxmargin := 0pt ; bb := bbox currentpicture ;
draw bb withpen pencircle scaled 1pt withcolor .625red ;
draw origin withpen pencircle scaled 5pt withcolor .625yellow ;
```



The `CONTEXT` distribution comes with a set of `METAPOST` modules, one of which contains the `drawfill` macro, which provides the outer bounding box.⁵ Next we demonstrate its use in another, more complicated example.

```
picture finalpicture ; finalpicture := nullpicture ;
numeric n ; n := 0 ; bboxmargin := 0pt ;
pickup pencircle scaled .5cm ;

def shape =
  unitsquare scaled 2cm withcolor .625white ;
  draw bbox currentpicture
    withpen pencircle scaled .5mm withcolor .625red ;
  addto finalpicture also currentpicture shifted(n*3cm,0) ;
  currentpicture := nullpicture ; n := n+1 ;
enddef ;

fill shape ; draw shape ; filldraw shape ; drawfill shape ;

currentpicture := finalpicture ;
```

Here we introduce a macro definition, `shape`. In `METAPOST`, the start of a macro definition is indicated with the keyword `def`. Thereafter, you can insert other variables and commands, even other macro definitions. The keyword `enddef` signals the end of the macro definition. The result is shown in figure 2.1; watch the bounding boxes. Close reading of the macro will reveal that the `fill`, `draw`, `filldraw` and `drawfill` macros are applied to the first `unitsquare` path in the macro.

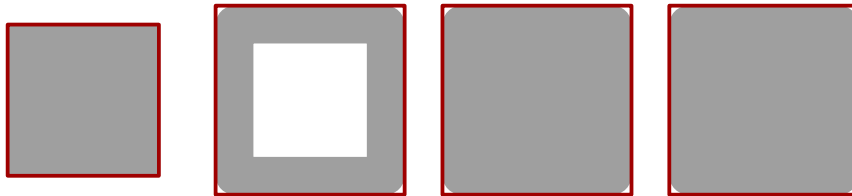

Figure 2.1 A `fill`, `draw`, `filldraw` and `drawfill` applied to the same square.

⁵ Starting from version 1.0 `METAPOST` calculates the boundingbox differently and the distinction between `drawfill` and `filldraw` is gone. We keep them around both for compatibility.

In this macro, `bbox` calls a macro that returns the enlarged bounding box of a path. By setting `bboxmargin` we can influence how much the bounding box is enlarged. Since this is an existing variable, we don't have to allocate it, like we do with `numeric n`. Unless you take special precautions, variables are global by nature and persistent outside macros.

```
picture finalpicture ; finalpicture := nullpicture ;
```

Just as `numeric` allocates an integer variable, the `picture` primitive allocates a picture data structure. We explicitly have to set this picture to nothing using the built-in primitive `nullpicture`.

Later on, we will add the drawn paths as accumulated in `currentpicture` to this `finalpicture` in the following manner.

```
addto finalpicture also currentpicture shifted(n*3cm,0) ;
```

Since we want to add a few more and don't want them to overlap, we shift them. Therefore we have to erase the current picture as well as increment the shift counter.

```
currentpicture := nullpicture ; n := n+1 ;
```

The `drawfill` macro is one of the `METAFUN` macros. Another handy macro is `boundingbox`. When used instead of `bbox`, you don't have to set the margin to zero.

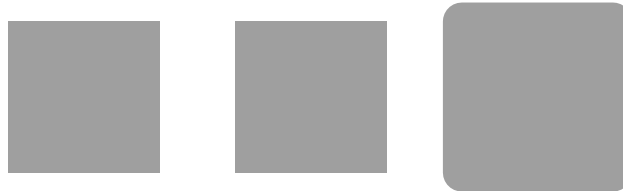

Figure 2.2 The influence of pens on fill.

There is a subtle point in filling a shape. In figure 2.2 you see the influence of the pen on a fill operation. An indirect specification has no influence, and results in a filled rectangle with sharp corners. The third rectangle is drawn with a direct pen specification which results in a larger shape with rounds corners. However, the bounding box is the same in all three cases. The graphic is defined as follows. This time we don't use a (complicated) macro.

```
drawoptions (withcolor .625white) ;
path p ; p := unitsquare scaled 2cm ;
fill p shifted (3cm,0) ;
pickup pencircle scaled .5cm ; fill p shifted (6cm,0) ;
fill p shifted (9cm,0) withpen pencircle scaled .5cm ;
```

When a graphic is constructed, its components end up in an internal data structure in a more or less layered way. This means that as long as a graphic is not flushed, you may consider it to be a stack of paths and texts with the paths being drawn or filled shapes or acting as clipping paths or bounding boxes.

When you ask for the dimensions of a graphic the lower left and upper right corner are calculated using this stack. Because you can explicitly set bounding boxes, you can lie about the dimensions of a graphic. This is a very useful feature. In the rare case that you want to know the truth and nothing but the truth, you can tweak the `truecorners` numeric variable. We will demonstrate this with a few examples.

```
fill fullcircle scaled 1cm withcolor .625yellow ;
```



```
fill fullcircle scaled 1cm withcolor .625yellow ;
setbounds currentpicture to boundingbox currentpicture enlarged 2mm ;
```



```
fill fullcircle scaled 1cm withcolor .625yellow ;
setbounds currentpicture to boundingbox currentpicture enlarged 2mm ;
interim truecorners := 1 ;
```



```
fill fullcircle scaled 1cm withcolor .625yellow ;
interim truecorners := 1 ;
setbounds currentpicture to boundingbox currentpicture enlarged 2mm ;
```



As you can see here, as soon as we set `truecorners` to 1, the bounding box settings are ignored.⁶

There are two related macros: `bbwidth` and `bbheight` that you can apply to a path.

```
fill unitcircle xscaled 4cm yscaled 2cm
  withpen pencircle scaled 1mm withcolor .625red ;
draw origin -- (bbwidth(currentpicture),0)
  withpen pencircle scaled 1mm withcolor .625yellow ;
draw origin -- (0,bbheight(currentpicture))
  withpen pencircle scaled 1mm withcolor .625white ;
```

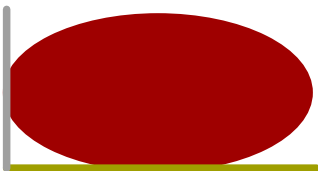

Yet another helper is `boundingcircle`. Its effect can best be demonstrated with a few examples:

```
path p ; p := fullsquare scaled 2cm ;

draw          p withpen pencircle scaled 3mm withcolor .625white ;
draw center   p withpen pencircle scaled 3mm withcolor .625white ;
draw boundingbox p withpen pencircle scaled 1mm withcolor .625red ;
draw boundingcircle p withpen pencircle scaled 1mm withcolor .625yellow ;
```

⁶ Normally you will use grouping to keep the interim local. In METAFUN each figure restores this variable at the beginning.

```

path p ; p := fullcircle scaled 2cm ;

draw          p withpen pencircle scaled 3mm withcolor .625white ;
draw center   p withpen pencircle scaled 3mm withcolor .625white ;
draw boundingbox p withpen pencircle scaled 1mm withcolor .625red ;
draw boundingcircle p withpen pencircle scaled 1mm withcolor .625yellow ;

path p ; p := fulltriangle scaled 2cm ;

draw          p withpen pencircle scaled 3mm withcolor .625white ;
draw center   p withpen pencircle scaled 3mm withcolor .625white ;
draw boundingbox p withpen pencircle scaled 1mm withcolor .625red ;
draw boundingcircle p withpen pencircle scaled 1mm withcolor .625yellow ;

```

You can consider the boundingcircle to be a round boundingbox.

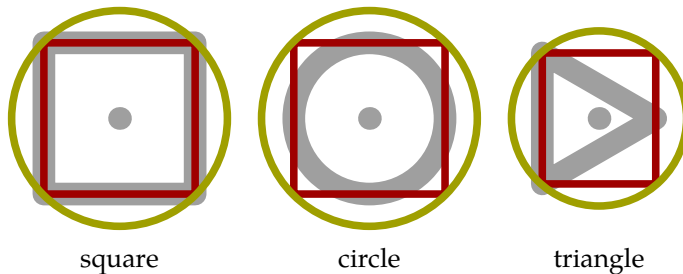

2.3 Units

Like \TeX , METAPOST supports multiple units of length. In \TeX , these units are hard coded and handled by the parser, where the internal unit of length is the scaled point (sp), something on the nanometer range. Because METAPOST is focused on POSTSCRIPT output, its internal unit is the big point (bp). All other units are derived from this unit and available as numeric instead of hard coded.

```

mm = 2.83464 ; pt = 0.99626 ; dd = 1.06601 ; bp := 1 ;
cm = 28.34645 ; pc = 11.95517 ; cc = 12.79213 ; in := 72 ;

```

Careful reading reveals that only the bp and in are fixed, while the rest of the dimensions are scalar multiples of bp.

Since we are dealing with graphics, the most commonly used dimensions are pt, bp, mm, cm and in.



The text in the center of the leftmost graphic is typeset by METAPOST as a label.

```

fill fullsquare scaled 72.27pt withcolor .625yellow ;
fill fullcircle scaled 72.27pt withcolor white ;
label("72.27pt", center currentpicture) ;

```

In METAPOST the following lines are identical:

```
draw fullcircle scaled 100 ;
draw fullcircle scaled 100bp ;
```

You might be tempted to omit the unit, but this can be confusing, particularly if you also program in a language like METAFONT, where the pt is the base unit. This means that a circle scaled to 100 in METAPOST is not the same as a circle scaled to 100 in METAFONT. Consider the next definition:

```
pickup pencircle scaled 0 ;
fill unitsquare
  xscaled 400pt yscaled -.5cm withcolor .625red ;
fill unitsquare
  xscaled 400bp yscaled +.5cm withcolor .625yellow ;
drawoptions(withcolor white) ;
label.rt("400 pt", origin shifted (0, -.25cm)) ;
label.rt("400 bp", origin shifted (0, +.25cm)) ;
```

When processed, the difference between a pt and bp shows rather well. Watch how we use .rt to move the label to the right; you can compare this with T_EX's macro \rlap. You might want to experiment with .lft, .top, .bot, .ulft, .urt, .llft and .lrt.

The difference between both bars is exactly 1.5pt (as calculated by T_EX).

400 bp

400 pt

Where T_EX is anchored in tradition, and therefore more or less uses the pt as the default unit, METAPOST, much like POSTSCRIPT, has its roots in the computer sciences. There, to simplify calculations, an inch is divided in 72 big points, and .72pt is sacrificed.

When you consider that POSTSCRIPT is a high end graphic programming language, you may wonder why this sacrifice was made. Although the difference between 1bp and 1pt is miniscule, this difference is the source of much (unknown) confusion. When T_EX users talk about a 10pt font, a desktop publisher hears 10bp. In a similar vein, when we define a papersize having a width of 600pt and a height of 450pt, which is papersize S6 in CONTEX_T, a POSTSCRIPT or PDF viewer will report slightly smaller values as page dimensions. This is because those programs claim the pt to be a bp. [This confusion can lead to interesting discussions with desktop publishers when they have to use T_EX. They often think that their demand of a baseline distance of 13.4 is met when we set it to 13.4pt, while actually they were thinking of 13.4bp, which of course in other programs is specified using a pt suffix.]

Therefore, when embedding graphics in CONTEX_T, we strongly recommend that you use pt as the base unit instead. The main reason why we spend so many words on this issue is that, when neglected, large graphics may look inaccurate. Actually, when taken care of, it is one of the (many) reasons why T_EX documents always look so accurate. Given that the eye is sensitive to distortions of far less than 1pt, you can be puzzled by the fact that many drawing programs only provide a bounding box in rounded units. Thereby, they round to the next position, to prevent unwanted cropping. For some reason this low resolution has made it into the high end POSTSCRIPT standard.

In CONTEX_T we try to deal with these issues as well as possible.

2.4 Scaling and shifting

When we draw a shape, METAPOST will adapt the bounding box accordingly. This means that a graphic has its natural dimensions, unless of course we adapt the bounding box manually. When you limit your graphic to a simple shape, say a rectangle, shifting it to some place can get obscured by this fact. Therefore, the following series of shapes appear to be the same.

```
draw
  unitsquare xscaled 6cm yscaled 1.5cm
  withpen pencircle scaled 2mm withcolor .625red ;
```



```
draw
  unitsquare shifted (.5,.5) xscaled 6cm yscaled 1.5cm
  withpen pencircle scaled 2mm withcolor .625red ;
```



```
draw
  unitsquare shifted (-.5,-.5) xscaled 6cm yscaled 1.5cm
  withpen pencircle scaled 2mm withcolor .625red ;
```



```
draw
  unitsquare xscaled 6cm yscaled 1.5cm shifted (1cm,1cm)
  withpen pencircle scaled 2mm withcolor .625red ;
```



```
draw
  unitsquare xscaled 6cm yscaled 1.5cm shifted (1.5cm,1cm)
  withpen pencircle scaled 2mm withcolor .625red ;
```



However, when we combine such graphics into one, we will see in what respect the scaling and shifting actually takes place.

```

draw
  unitsquare xscaled 6cm yscaled 2cm
  withpen pencircle scaled 3.0mm withcolor .625yellow ;
draw
  unitsquare shifted (.5,.5) xscaled 6cm yscaled 2cm
  withpen pencircle scaled 3.0mm withcolor .625red ;
draw
  unitsquare xscaled 6cm yscaled 2cm shifted (1cm,1cm)
  withpen pencircle scaled 3.0mm withcolor .625white ;
draw
  unitsquare xscaled 6cm yscaled 2cm shifted (1.5cm,1cm)
  withpen pencircle scaled 1.5mm withcolor white ;
draw
  unitsquare shifted (-.5,-.5) xscaled 6cm yscaled 2cm
  withpen pencircle scaled 1mm withcolor black ;
draw origin withpen pencircle scaled 1mm ;

```

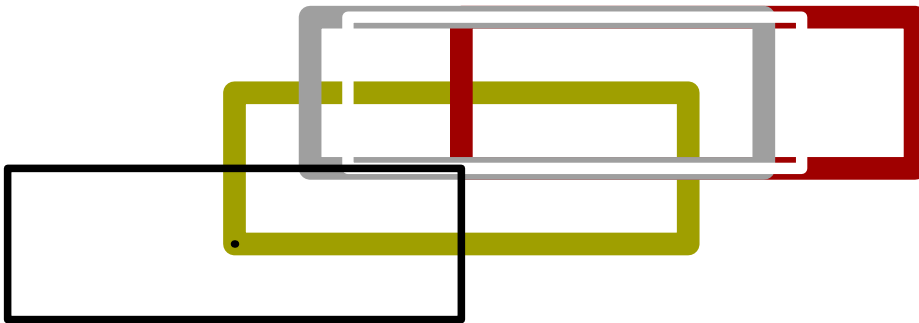

As you can see, the transformations are applied in series. Sometimes this is not what we want, in which case we can use parentheses to force the desired behaviour. The lesson learned is that *scaling and shifting* is not always the same as *shifting and scaling*.

```

draw
  origin -- origin shifted ((4cm,0cm) shifted (4cm,0cm))
  withpen pencircle scaled 1cm withcolor .625white ;
draw
  origin -- origin shifted (4cm,0cm) shifted (4cm,0cm)
  withpen pencircle scaled 8mm withcolor .625yellow ;
draw
  (origin -- origin shifted (4cm,0cm)) shifted (4cm,0cm)
  withpen pencircle scaled 6mm withcolor .625red ;
draw
  origin -- (origin shifted (4cm,0cm) shifted (4cm,0cm))
  withpen pencircle scaled 4mm withcolor white ;

```



Especially when a path results from a call to a macro, using parentheses around a path may help, as in the following example.

```

def unitlant = origin -- origin shifted (1,1) endef ;

```

```

draw
  unitslant xscaled 5cm yscaled 1cm
  withpen pencircle scaled 1cm withcolor .625red ;
draw
  (unitslant) xscaled 5cm yscaled 1cm
  withpen pencircle scaled 5mm withcolor .625yellow ;

```

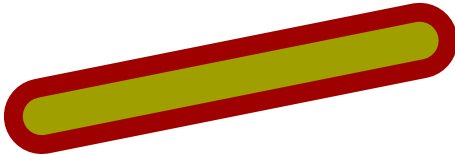

The next definition of `unitslant` is therefore better.

```

def unitslant = (origin -- origin shifted (1,1)) enddef ;
draw
  unitslant xscaled 5cm yscaled 1cm
  withpen pencircle scaled 5mm withcolor .625red ;

```



An even better alternative is:

```

path unitslant ; unitslant = origin -- origin shifted (1,1) ;
draw
  unitslant xscaled 5cm yscaled 1cm
  withpen pencircle scaled 5mm withcolor .625yellow ;

```



2.5 Curve construction

Chapter 3 of the METAFONT book explains the mathematics behind the construction of curves. Both METAFONT and METAPOST implement Bézier curves. The fact that these curves are named after Pierre Bézier obscures the fact that the math behind them originates with Sergeï Bernšteïn.

The points on the curve are determined by the following formula:

$$z(t) = (1 - t)^3 z_1 + 3(1 - t)^2 t z_2 + 3(1 - t) t^2 z_3 + t^3 z_4$$

Here, the parameter t runs from $[0, 1]$. As you can see, we are dealing with four points. In practice this means that when we construct a curve from multiple points, we act on two points and the two control points in between. So, the segment that goes from z_1 to z_4 is calculated using these two points and the points that METAFONT/METAPOST calls post control point and pre control point.

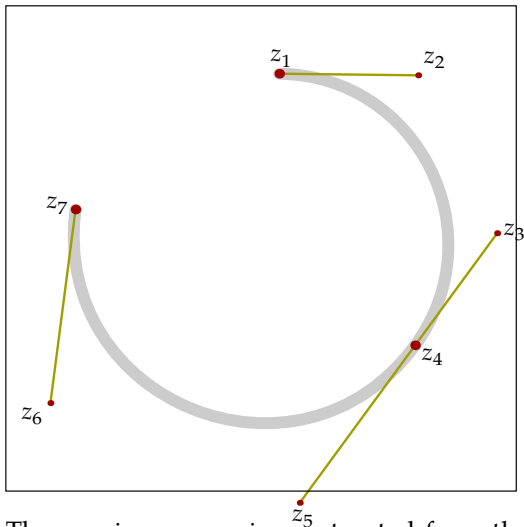

The previous curve is constructed from the three points z_1 , z_4 and z_7 . The curve is drawn in METAPOST by $z_1..z_4..z_7$ and is made up out of two segments. The first segment is determined by the following points:

1. point z_1 of the curve
2. the postcontrol point z_2 of z_1
3. the precontrol point z_3 of z_4
4. point z_4 of the curve

On the next pages we will see how the whole curve is constructed from these quadruples of points. The process comes down to connecting the mid points of the straight lines to the points mentioned. We do this three times, which is why these curves are classified as third order approximations.

The first series of graphics demonstrates the process of determining the mid points. The third order midpoint is positioned on the final curve. The second series focuses on the results: new sets of four points that will be used in a next stage. The last series only shows the third order midpoints. As you can see, after some six iterations we have already reached a rather good fit of the final curve. The exact number of iterations depends on the resolution needed. You will notice that the construction speed (density) differs per segment.

The path in these examples is defined as follows:

```
path p ; p := (4cm,4cm)..(6cm,0cm)..(1cm,2cm) ;
```

If you are playing with graphics like this, the METAFUN macro `randomize` may come in handy:

```
p := p randomized (1cm,.5cm) ;
```

If we apply this operation a couple of times we can see how the (control) points vary. (Using the randomizer saves us the troubles of finding nice example values.) The angle between the tangent as well as the distance from the parent point determine the curve.

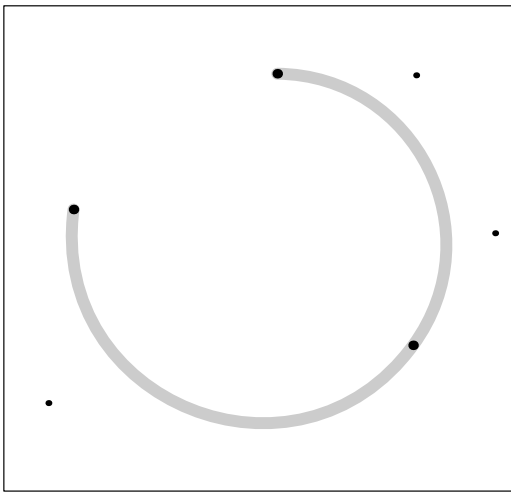

points

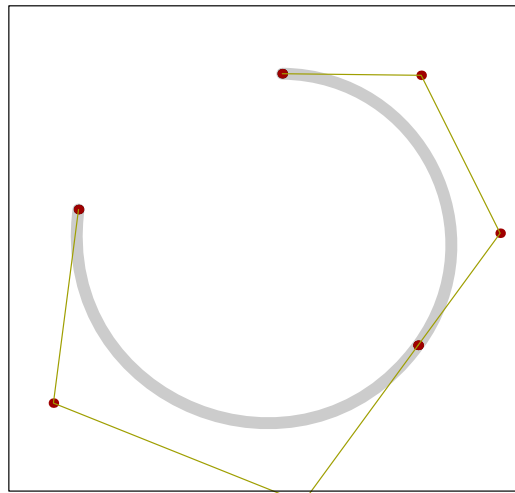

first order curve

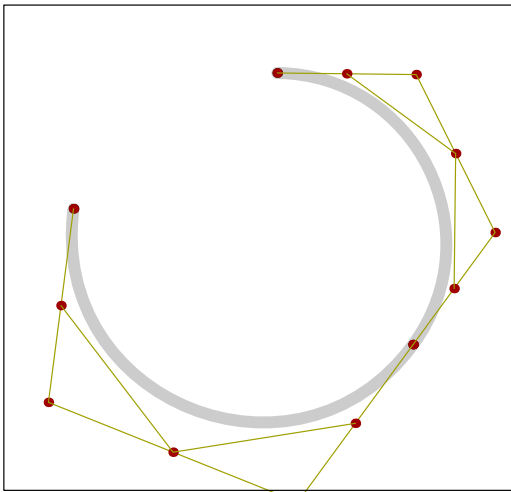

second order curve

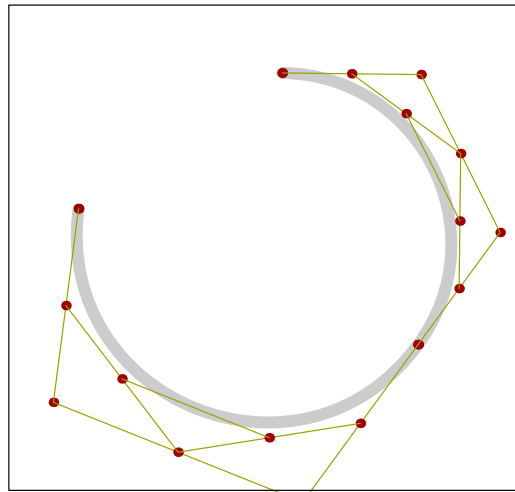

third order curve

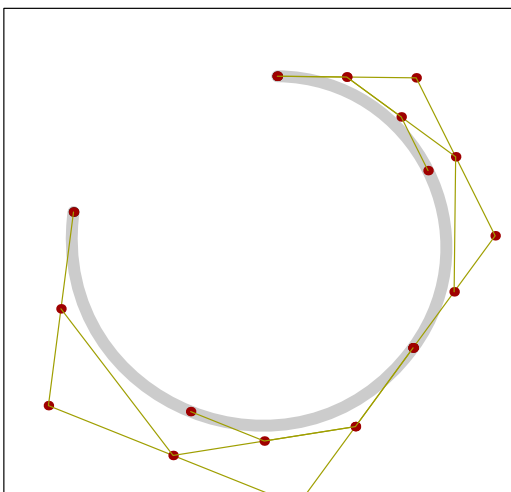

left side curves

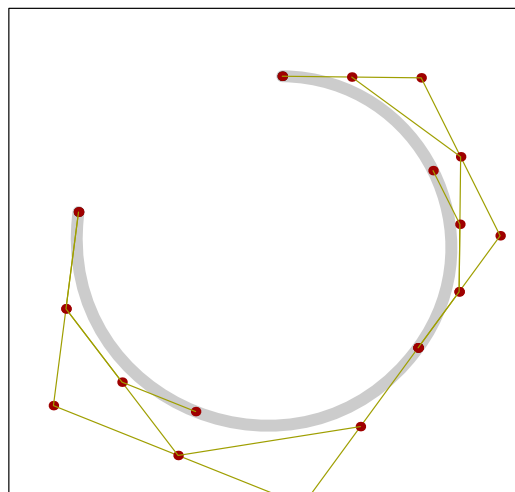

right side curves

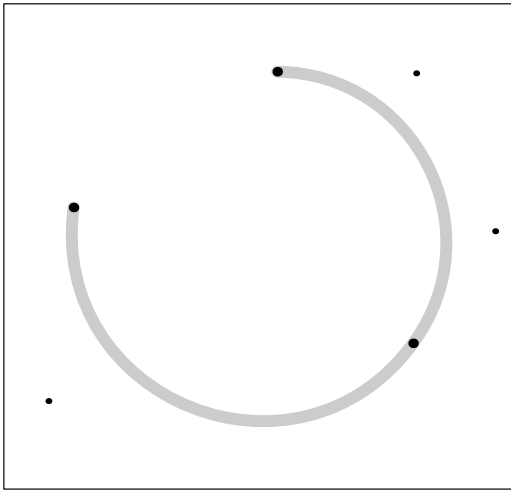

points

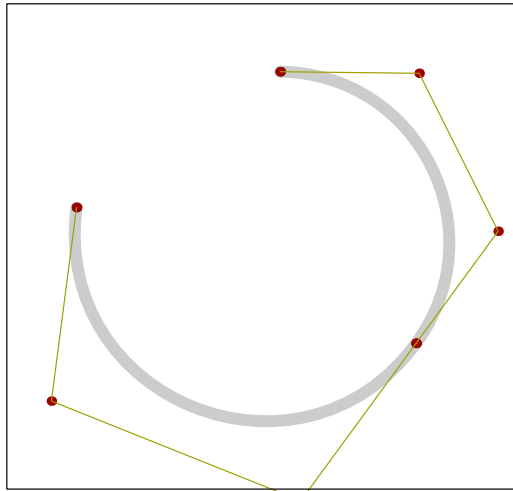

first order points

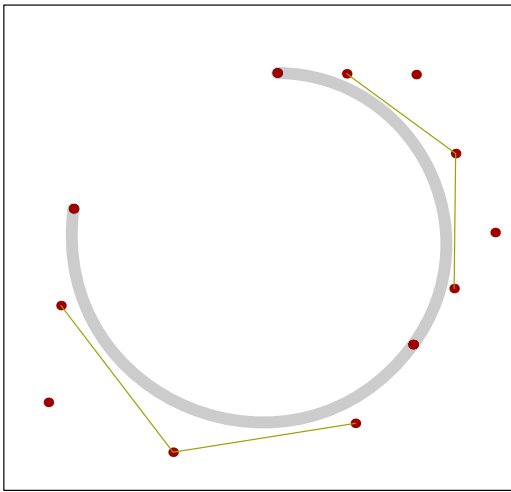

second order points

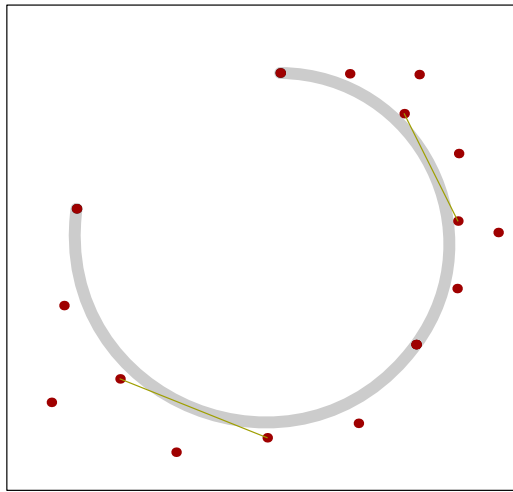

third order points

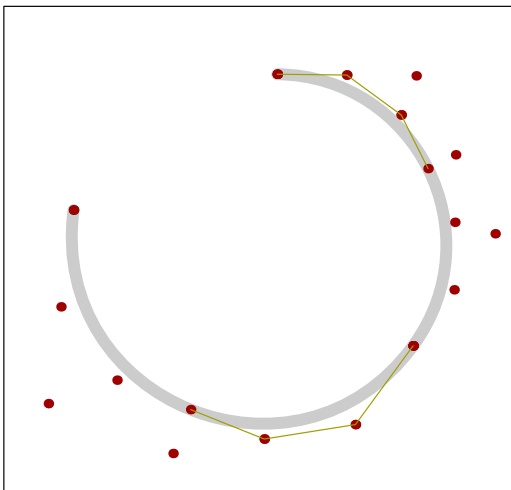

left side points

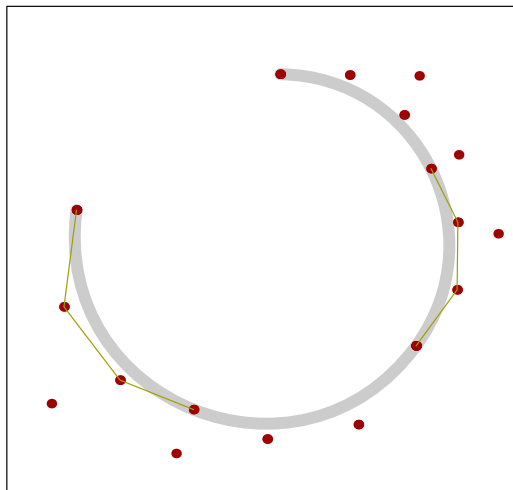

right side points

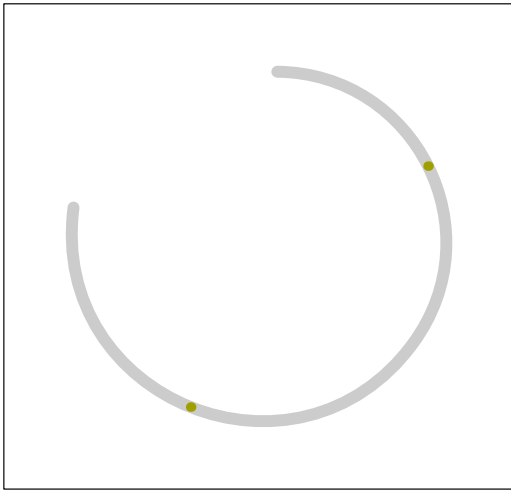

first iteration

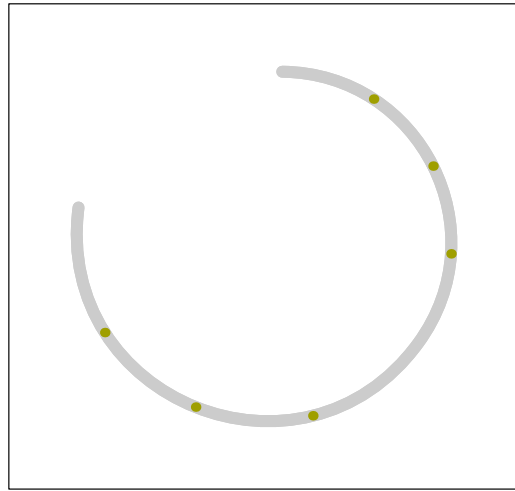

second iteration

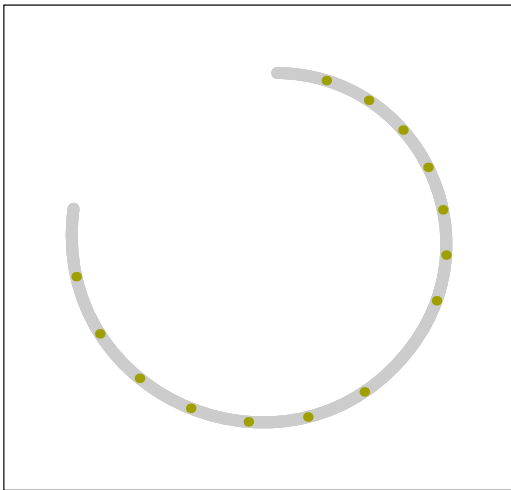

third iteration

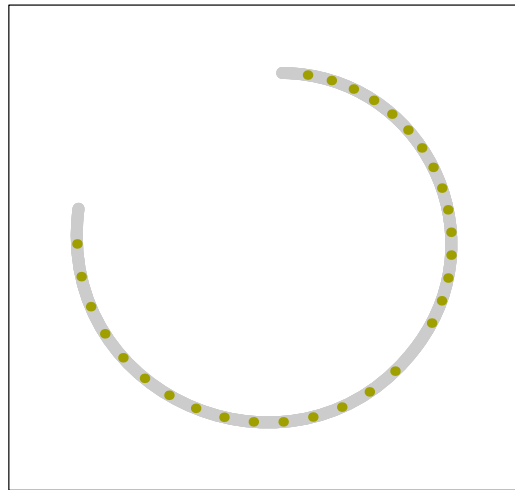

fourth iteration

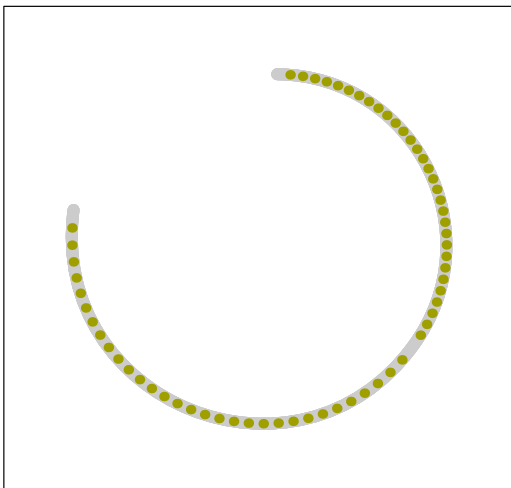

fifth iteration



sixths iteration

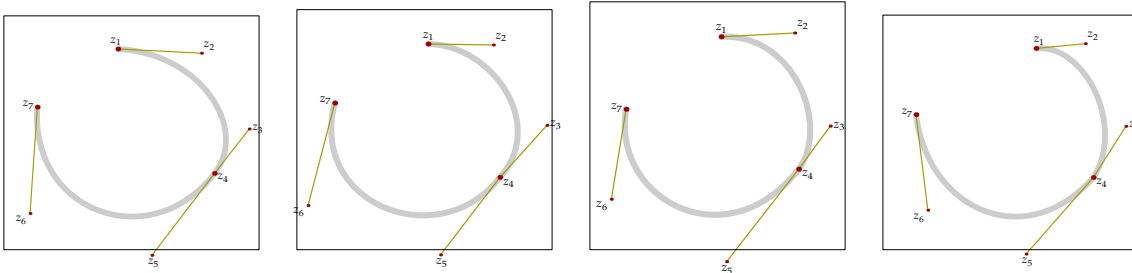

Just in case you are interested in how such graphical simulations can be organized, we show simplified versions of the macros used here. (In the previous examples we minimized the complexity of the code by using buffers, but describing this mechanism is out of the scope of this section.)

We need to loop over all segments of a curve, where for each segment the left and right side sub curves are handled recursively, upto the requested depth (denoted as n). For this we define the following macros.

```

vardef dodrawmidpoints (expr a, b, c, d, n) =
  save e, f, g, h, i, j ; pair e, f, g, h, i, j ;
  e := .5[a,b] ; f := .5[b,c] ; g := .5[c,d] ;
  h := .5[e,f] ; i := .5[f,g] ; j := .5[h,i] ;
  draw j ;
  if n>1 :
    dodrawmidpoints(a, e, h, j, n-1) ;
    dodrawmidpoints(j, i, g, d, n-1) ;
  fi ;
enddef ;

vardef drawmidpoints (expr p, n) =
  save a, b, c, d ; pair a, b, c, d ;
  for x=0 upto length(p)-1 :
    a := point x of p ; b := postcontrol x of p ;
    d := point x+1 of p ; c := precontrol x+1 of p ;
    dodrawmidpoints(a, b, c, d, n) ;
  endfor ;
enddef ;

```

We apply this macro to a simple shape:

```
drawmidpoints (fullcircle xscaled 300pt yscaled 50pt, 1) ;
```

When drawn, this results in the points that makes up the curve:



We now add an extra iteration (resulting in the yellow points):

```
drawmidpoints (fullcircle xscaled 300pt yscaled 50pt, 2) ;
```

and get:



We don't even need that much iterations to get a good result. The depth needed to get a good result depends on the size of the pen and the resolution of the device on which the curve is visualized.

```
for i=1 upto 7 :
  drawmidpoints (fullcircle
    xscaled (300pt+i*10pt) yscaled (50pt+i*10pt), i) ;
endfor ;
```

Here we show 7 iterations in one graphic.

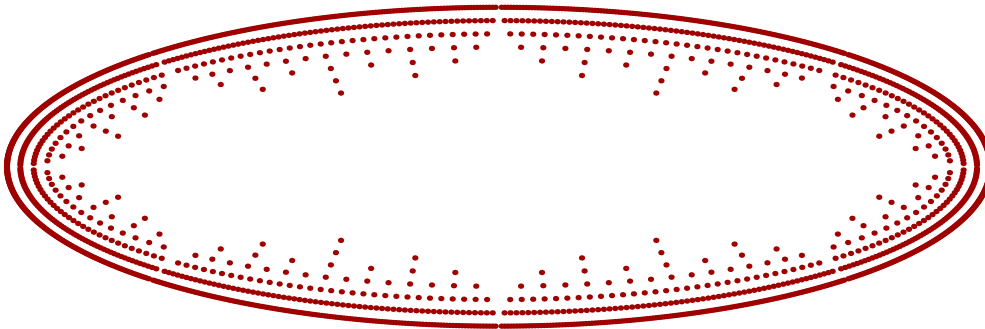

In practice it is not that trivial to determine the depth needed. The next example demonstrates how the resolution of the result depends on the length and nature of the segment.

```
drawmidpoints (fullsquare
  xscaled 300pt yscaled 50pt randomized (20pt,10pt), 5) ;
```



2.6 Inflection, tension and curl

The METAPOST manual describes the meaning of `...` as “choose an inflection-free path between these points unless the endpoint directions make this impossible”. To use the words of David Arnold: a point of inflection is where a path switches concavity, from concave up to concave down, for example.

It is surprisingly difficult to find nice examples that demonstrate the difference between `..` and `...`, as it is often ‘impossible’ to honour the request for less inflection. We will demonstrate this with a few graphics.

In the four figures on the next pages, you will see that `...` is not really suited for taming wild curves. If you really want to make sure that a curve stays within certain bounds, you have to specify it as such using control or intermediate points. In the figures that follow, the gray curves

draw the random path using .. on top of yellow curves that use the ... connection. As you can see, in only a few occasions do the yellow 'inflection' free curves show up.

For those who asked for the code that produces these pictures, we now include it here. We use a macro `sample` which we define as a usable graphic (nearly all examples in this manual are coded in the document source).

```

\startuseMPgraphic{sample}
def sample (expr rx, ry) =
  path p, q ; numeric n, m, r, a, b ;
  color c ; c := \MPcolor{lightgray} ;
  a := 3mm ; b := 2mm ; r := 2cm ; n := 7 ; m := 5 ;
  q := unitsquare scaled r xyscaled (n,m) shifted (.5r,.5r) ;
  draw q withpen pencircle scaled (b/4) withcolor .625yellow;
  for i=1 upto n : for j=1 upto m :
    p := (fullcircle scaled r randomized (r/rx,r/ry))
      shifted ((i,j) scaled r) ;
    pickup pencircle scaled a ;
    draw for k=0 upto length(p) :
      point k of p .. endfor cycle withcolor c ;
    draw for k=0 upto length(p) :
      point k of p ... endfor cycle withcolor c ;
    pickup pencircle scaled b ;
    draw for k=0 upto length(p) :
      point k of p .. endfor cycle withcolor .625yellow ;
    draw for k=0 upto length(p) :
      point k of p ... endfor cycle withcolor .625white ;
    for k=0 upto length(p) :
      draw point k of p withcolor .625red ;
    endfor ;
  endfor ; endfor ;
  setbounds currentpicture to q ;
enddef ;
\stopuseMPgraphic

```

As you see, not so much code is needed. The graphics themselves were produced with a couple of commands like:

```

\placefigure
{Circles with minimized inflection and 25% randomized points.}
{\startMPcode
  \includeMPgraphic{sample} ; sample(4,4) ;
  \stopMPcode}

```

The tension specifier can be used to influence the curvature. To quote the METAPOST manual once more: "The tension parameter can be less than one, but it must be at least 3/4". The following paths are the same:

```

z1 .. z2
z1 .. tension 1 .. z2
z1 .. tension 1 and 1 .. z2

```

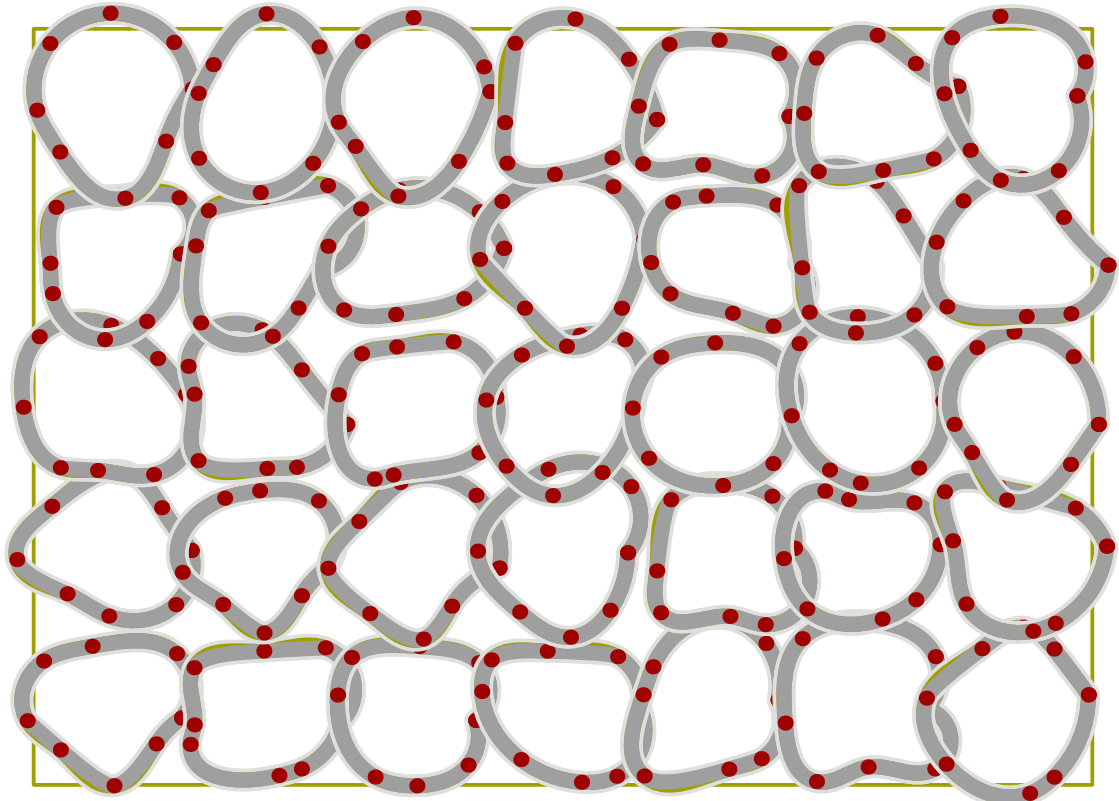

Figure 2.3 Circles with minimized inflection and 25% randomized points.

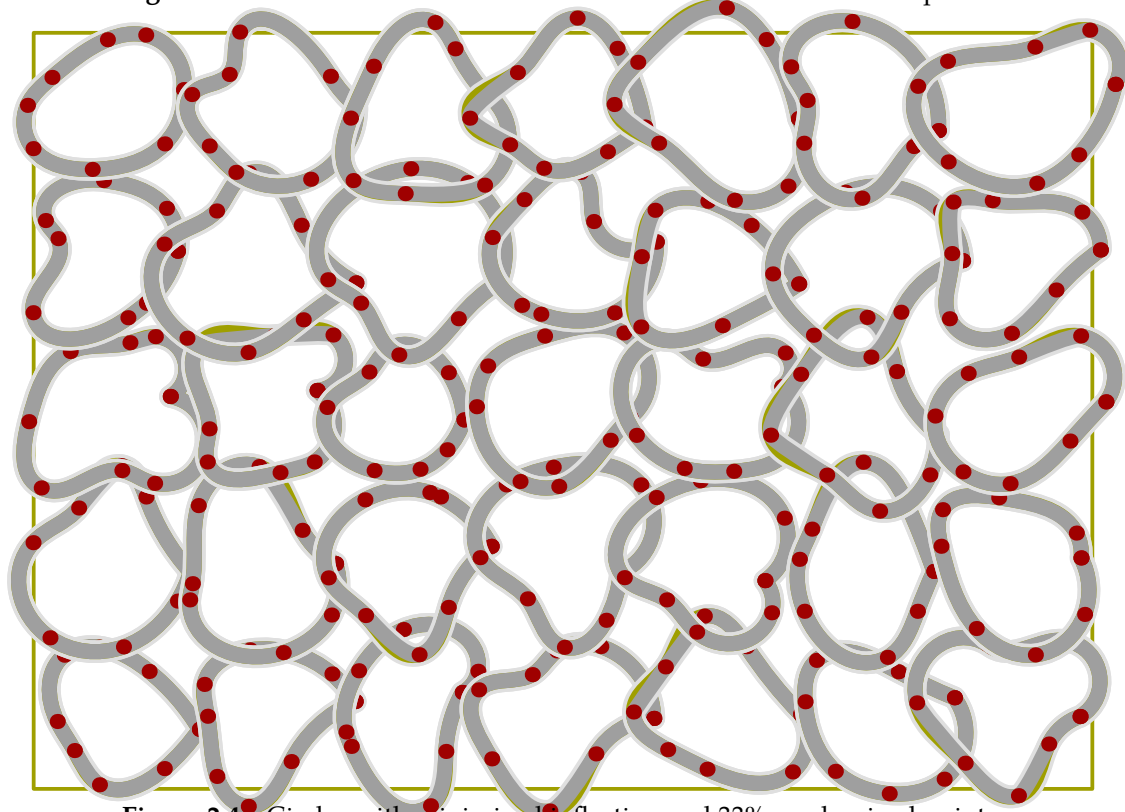

Figure 2.4 Circles with minimized inflection and 33% randomized points.

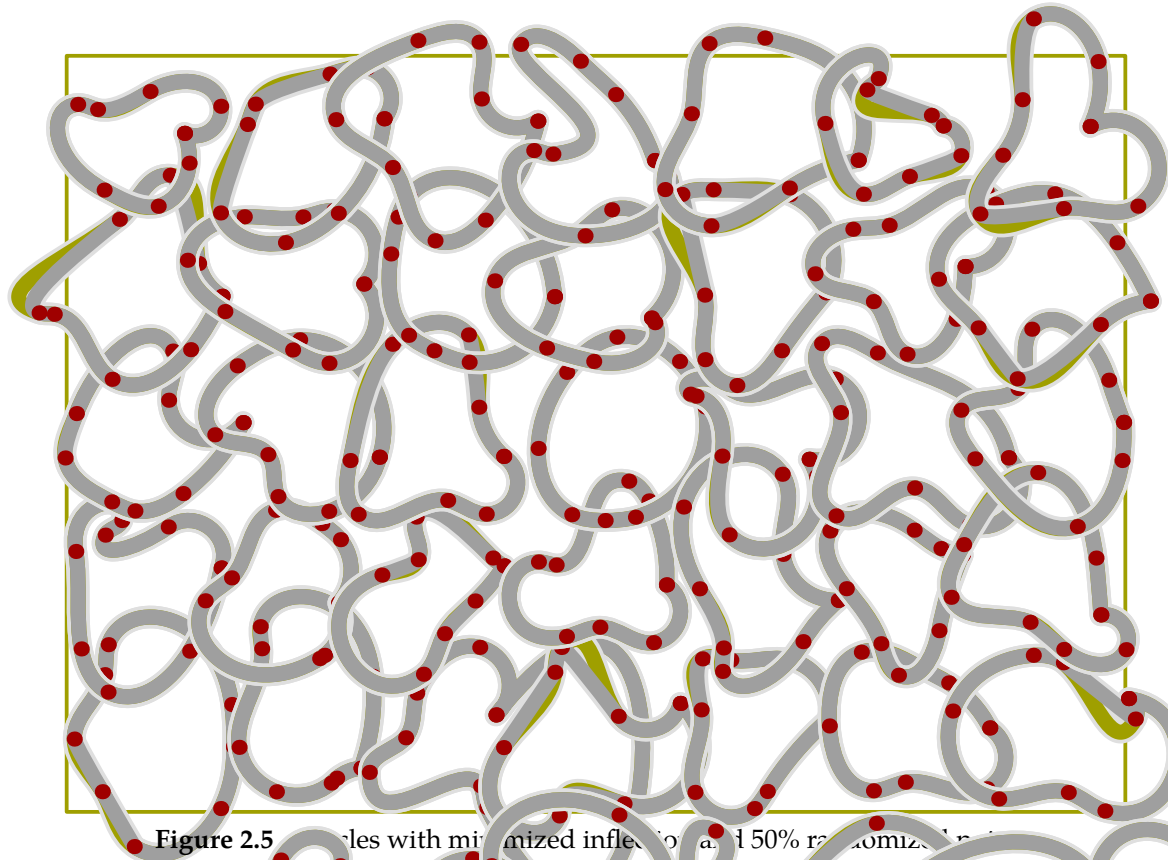

Figure 2.5 Circles with minimized inflection and 150% randomized points.

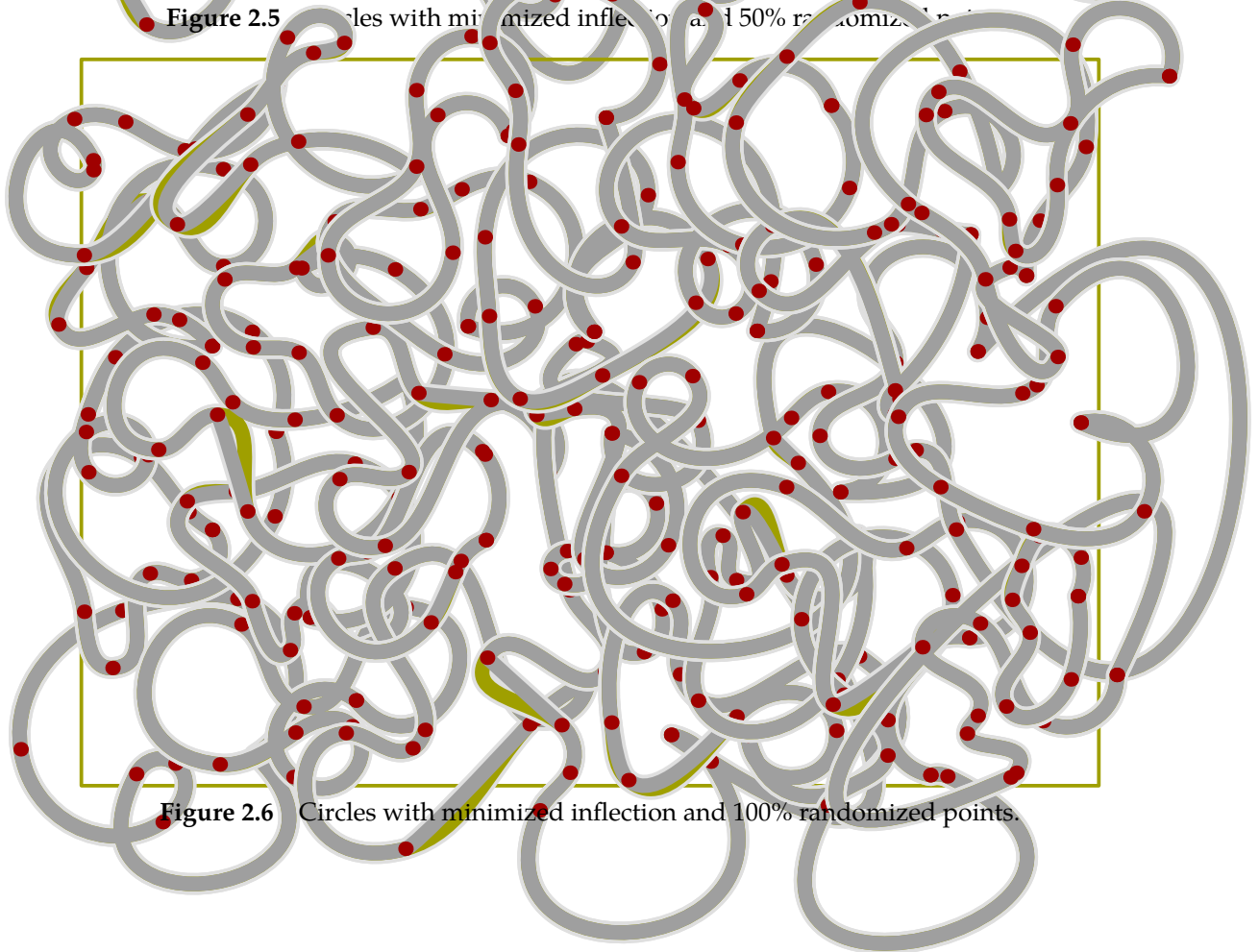

Figure 2.6 Circles with minimized inflection and 100% randomized points.

The triple dot command `...` is actually a macro that makes the following commands equivalent. Both commands will draw identical paths.

```
z1 ... z2
z1 .. tension atleast 1 .. z2
```

The `atleast` directive tells METAPOST to do some magic behind the screens. Both the `3/4` and the `atleast` lead directly to the question: “What, exactly, is the influence of the tension directive?” We will try to demystify the `tension` specifier through a sequence of graphics.

```
u := 1cm ; z1 = (0,0) ; z2 = (2u,4u) ; z3 = (4u,0) ;
def sample (expr p, c) =
  draw p withpen pencircle scaled 2.5mm withcolor white ;
  draw p withpen pencircle scaled 2.0mm withcolor c ;
enddef ;
for i=.75 step .05 until 1 :
  sample (z1 .. tension i .. z2 .. z3, .625red) ;
endfor ;
for i=1 step .05 until 2 :
  sample (z1 .. tension i .. z2 .. z3, .625yellow) ;
endfor ;
sample (z1 .. z2 .. z3, .625white) ;
sample (z1 ... z2 ... z3, .625white) ;
```

Indeed values less than `.75` give an error message, but large values are okay. As you can see, the two gray curves are the same. Here, `atleast 1` means 1, even if larger values are useful.

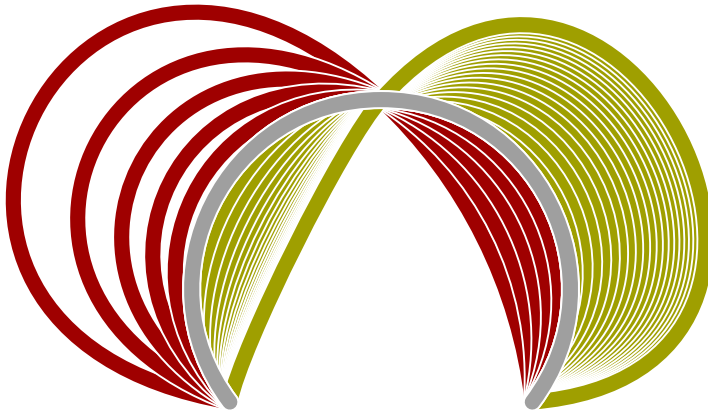

Curves finally are made up out of points, and each point has two control points. Since the `tension` specifier finally becomes a control point, it is not surprising that you may specify two tension values. If we replace the `tension` in the previous example by

```
.. tension i and 2i ..
```

we get the following graphic:

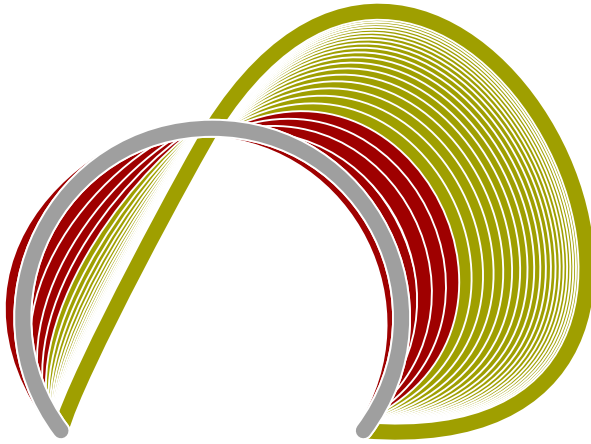

If we swap both values (`.. tension 2i` and `i ..`) we get:

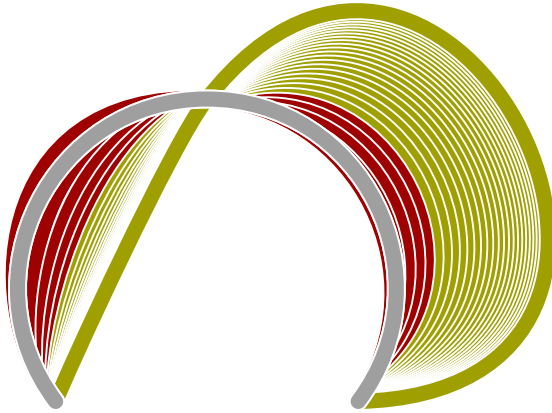

We mentioned control points. We will now draw a few extreme tensions and show the control points as METAPOST calculates them.

```
sample (z1 .. tension 0.75 .. z2 .. z3, .625red) ;
sample (z1 .. tension 2.00 .. z2 .. z3, .625yellow) ;
sample (z1 ..                z2 .. z3, .625white) ;
```

First we will show the symmetrical tensions.

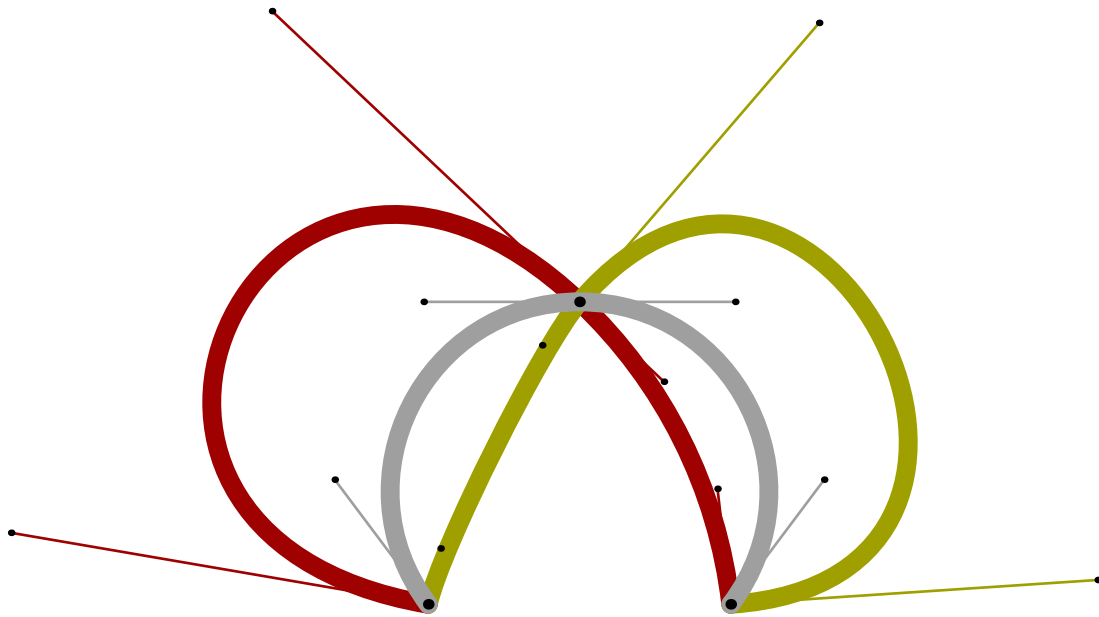

The asymmetrical tensions are less prominent. We use the following values:

```
sample (z1 .. tension .75 and 10 .. z2 .. z3, .625red) ;
sample (z1 .. tension 10 and .75 .. z2 .. z3, .625yellow) ;
sample (z1 .. z2 .. z3, .625white) ;
```

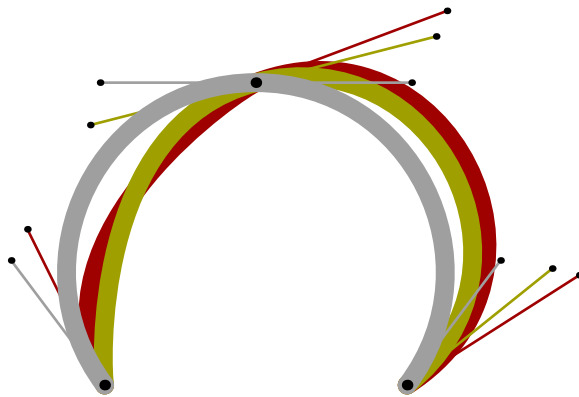

What happens when you use the METAPOST maximum value of infinity instead of 10? Playing with this kind of graphic can be fun, especially when we apply a few tricks.

```
def sample (expr p, c) =
  draw p withpen pencircle scaled 2.5mm withcolor white ;
  draw p withpen pencircle scaled 2.0mm withcolor c ;
enddef;

u := 1cm ; z1 = (0,0) ; z2 = (2u,4u) ; z3 = (4u,0) ;

for i=0 step .05 until 1 :
  sample(z1 .. tension (.75+i) .. z2 .. z3, i[.625red,.625yellow]) ;
endfor;
```

Here we change the color along with the tension. This clearly demonstrates that we're dealing with a non linear phenomena.

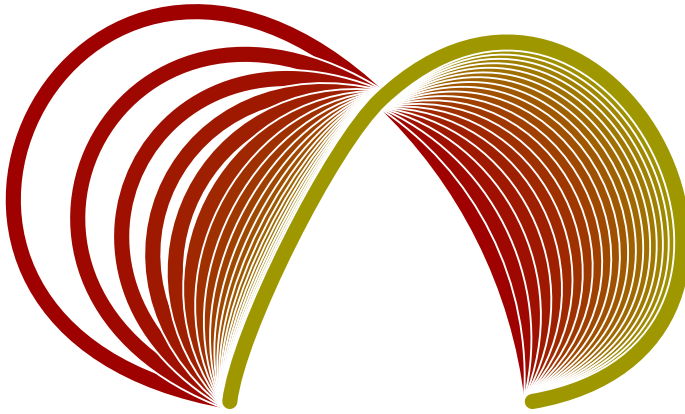

We can (misuse) transparent colors to illustrate how the effect becomes less with growing tension.

```
def sample (expr p) (text c)=
  draw p withpen pencircle scaled 2.0mm withcolor c ;
enddef;

u := 1cm ; z1 = (0,0) ; z2 = (2u,4u) ; z3 = (4u,0) ;

for i=0 step .05 until 1 :
  sample(z1 .. tension (.75+i) .. z2 .. z3, transparent(1,1-i,.625red)) ;
endfor;
```

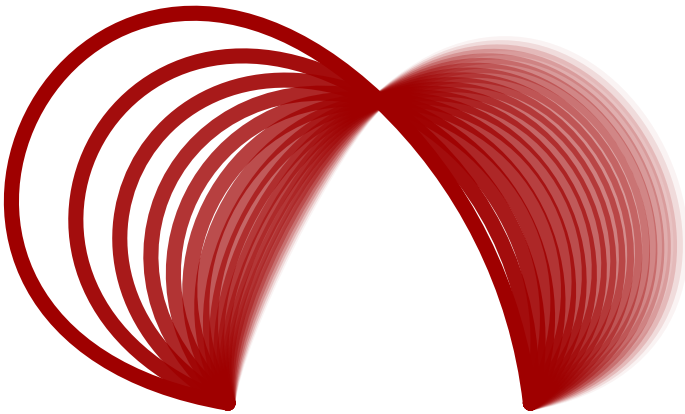

A third magic directive is `curl`. The curl is attached to a point between `{ }`, like `{curl 2}`. Anything between curly braces is a direction specifier, so instead of a `curl` you may specify a vector, like `{(2,3)}`, a pair of numbers, as in `{2,3}`, or a direction, like `{dir 30}`. Because vectors and angles are straightforward, we will focus a bit on `curl`.

```
z0 .. z1 .. z2
z0 {curl 1} .. z1 .. {curl 1} z2
```

So, a `curl` of 1 is the default. When set to 1, the begin and/or end points are approached. Given the following definitions:

```
u := 1cm ; z1 = (0,0) ; z2 = (2u,4u) ; z3 = (4u,0) ;
```

```
def sample (expr p, c) =
  draw p withpen pencircle scaled 2.5mm withcolor white ;
  draw p withpen pencircle scaled 2.0mm withcolor c ;
enddef ;
```

We can draw three curved paths.

```
sample (z1 {curl 0} .. z2 .. {curl 0} z3, .625red) ;
sample (z1 {curl 2} .. z2 .. {curl 2} z3, .625yellow) ;
sample (z1 {curl 1} .. z2 .. {curl 1} z3, .625white) ;
```

The third (gray) curve is the default situation, so we could have left the `curl` specifier out of the expression.

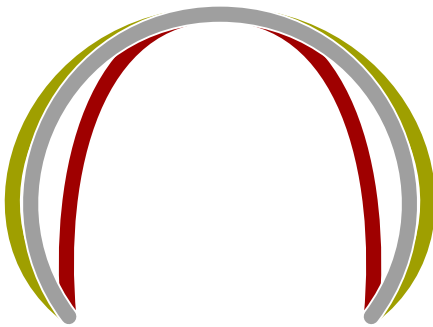

The curly specs have a lower bound of zero and no upper bound. When we use METAPOST maximum value of `infinity` instead of 2, we get:

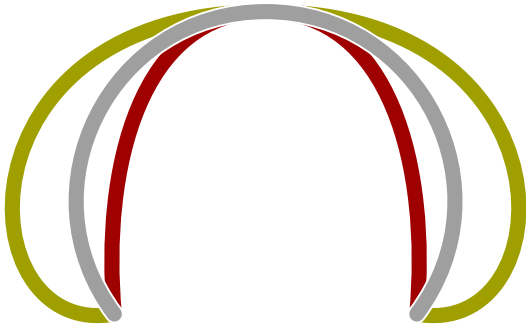

These curves were defined as:

```
sample (z1 {curl      0} .. z2 .. {curl      0} z3, .625red) ;
sample (z1 {curl infinity} .. z2 .. {curl infinity} z3, .625yellow) ;
sample (z1 {curl      1} .. z2 .. {curl      1} z3, .625white) ;
```

It may sound strange, but internally METAPOST can handle larger values than `infinity`.

```
sample (z1 {curl infinity} .. z2 .. {curl infinity} z3, .625red) ;
sample (z1 {curl 4infinity} .. z2 .. {curl 4infinity} z3, .625yellow) ;
sample (z1 {curl 8infinity} .. z2 .. {curl 8infinity} z3, .625white) ;
```

Although this is quite certainly undefined behaviour, interesting effects can be achieved. When you turn off METAPOST's first stage overflow catcher by setting `warningcheck` to zero, you can go

upto 8 times infinity, which, being some 2^{15} , is still far from what today's infinity is supposed to be.

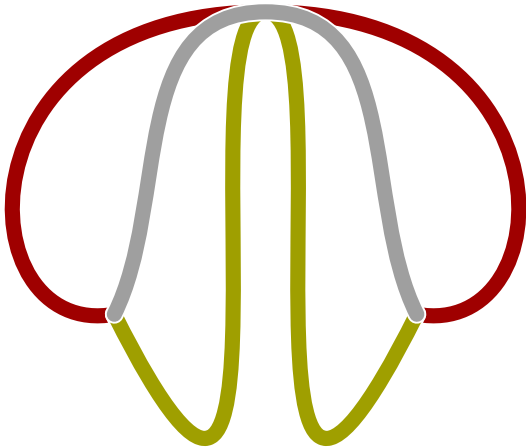

As the built-in METAPOST command `..` accepts the `curl` and `tension` directives as described in this section, you will now probably understand the following plain METAPOST definitions:

```
def -- = {curl 1} .. {curl 1}   enddef ;
def --- = .. tension infinity .. enddef ;
def ... = .. tension atleast 1 .. enddef ;
```

These definitions also point out why you cannot add directives to the left or right side of `--`, `---` and `...`: they are directives themselves!

2.7 Transformations

A transform is a vector that is used in what is called an affine transformation. To quote the METAPOST manual:

"If $p = (p_x, p_y)$ is a pair and T is a transform, then p transform T is a pair of the form:

$$(t_x + t_{xx}p_x + t_{xy}p_y, t_y + t_{yx}p_x + t_{yy}p_y)$$

where the six numeric quantities $(t_x, t_y, t_{xx}, t_{xy}, t_{yx}, t_{yy})$ determine T ."

In literature concerning POSTSCRIPT and PDF you will find many references to such transformation matrices. A matrix of $(s_x, 0, 0, s_y, 0, 0)$ is scaling by s_x in the horizontal direction and s_y in the vertical direction, while $(1, 0, t_x, 1, 0, t_y)$ is a shift over t_x, t_y . Of course combinations are also possible.

Although these descriptions seem in conflict with each other in the nature and order of the transform components in the vectors, the concepts are the same. You normally populate transformation matrices using `scaled`, `shifted`, `rotated`.

```
transform t ; t := identity shifted (a,b) rotated c scaled d ;
path p ; p := fullcircle transformed t ;
```

The previous lines of code are equivalent to:

```
path p ; p := fullcircle shifted (a,b) rotated c scaled d ;
```

You always need a starting point, in this case the identity matrix identity: $(0, 0, 1, 0, 0, 1)$. By the way, in POSTSCRIPT the zero vector is $(1, 0, 0, 1, 0, 0)$. So, unless you want to extract the components using `xpart`, `xypart`, `xxpart`, `ypart`, `yxpart` and/or `yypart`, you may as well forget about the internal representation.

You can invert a transformation using the `inverse` macro, which is defined as follows, using an equation:

```
vardef inverse primary T =
  transform T_ ; T_ transformed T = identity ; T_
enddef ;
```

Using transform matrices makes sense when similar transformations need to be applied on many paths, pictures, pens, or other transforms. However, in most cases you will use the predefined commands `scaled`, `shifted`, `rotated` and alike. We will now demonstrate the most common transformations in a text example.

```
draw btex \bfd MetaFun etex ;
draw boundingbox currentpicture withcolor .625yellow ;
```

Before an independent METAPOST run, the `btex ... etex`'s are filtered from the file and passed on to \TeX . After that, the DVI file is converted to a list of pictures, which is consulted by METAPOST. This is no longer the case in L $\text{UAT}\text{E}\text{X}$ where we use MPLIB, so users don't have to worry about these issues: just ignore what is mentioned in the official METAPOST manual.

We can manipulate the pictures representing text like any graphic as well as draw it with `draw`.

MetaFun

We show the transformations in relation to the origin and make the origin stand out a bit more by painting it a bit larger in white first.

```
draw origin withpen pencircle scaled 1.5mm withcolor white ;
draw origin withpen pencircle scaled 1mm withcolor .625red
```

The origin is in the lower left corner of the picture.

MetaFun

Because the transformation keywords are proper english, we let the pictures speak for themselves.

```
currentpicture := currentpicture shifted (0,-1cm) ;
```

.

MetaFun

```
currentpicture := currentpicture rotated 180 ;
```

MetaFun

```
currentpicture := currentpicture rotatedaround(origin,30) ;
```

MetaFun

```
currentpicture := currentpicture scaled 1.75 ;
```

MetaFun

```
currentpicture := currentpicture scaled -1 ;
```

MetaFun

```
currentpicture := currentpicture xscaled 3.50 ;
```

MetaFun

```
currentpicture := currentpicture xscaled -1 ;
```

MetaFun

```
currentpicture := currentpicture yscaled .5 ;
```

MetaFun

```
currentpicture := currentpicture yscaled -1 ;
```

MetaFun

```
currentpicture := currentpicture slanted .5 ;
```

MetaFun

```
currentpicture := currentpicture slanted -.5 ;
```

MetaFun

```
currentpicture := currentpicture zscaled (.75,.25) ;
```

MetaFun

```
currentpicture := currentpicture
  reflectedabout(llcorner currentpicture,urcorner currentpicture) ;
```



A path has a certain direction. When the turningnumber of a path is larger than zero, it runs in clockwise direction. The METAPOST primitive `reverse` changes the direction, while the macro `counterclockwise` can be used to get a path running in a well defined direction.

```
drawoptions(withpen pencircle scaled 2pt withcolor .625red) ;
path p ; p := fullcircle scaled 1cm ;
drawarrow p ;
drawarrow reverse p shifted (2cm,0) ;
drawarrow counterclockwise p shifted (4cm,0) ;
drawarrow counterclockwise reverse p shifted (6cm,0) ;
drawarrow reverse counterclockwise p shifted (8cm,0) ;
```



2.8 Only this far

When you take a close look at the definitions of the Computer Modern Roman fonts, defined in the METAFONT book, you will notice a high level of abstraction. Instead of hard coded points you will find points defined in terms of ‘being the same as this point’ or ‘touching that point’. In this section we will spend some time on this touchy aspect.



This rectangle is a scaled instance of the predefined METAFUN path `fullsquare` which is centered around the origin.

```
pickup pencircle scaled 2mm ;
path p ; p := fullsquare scaled 2cm ;
draw p withcolor .625white ;
```

On this path, halfway between two of its corners, we define a point `q`:

```
pair q ; q := .5[llcorner p, lrcorner p] ;
```

We draw this point in red, using:

```
draw q withcolor .625red ;
```

As you can see, this point is drawn on top of the path.

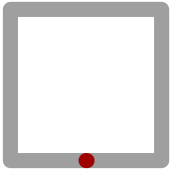

There are four of those midpoints, and when we connect them, we get:

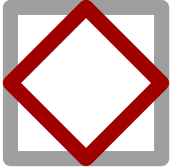

Because path `p` is centered around the origin, we can simply rotate point `q` a few times.

```
draw q -- q rotated 90 -- q rotated 180 --
      q rotated 270 -- cycle withcolor .625red ;
```

There are situations, where you don't want the red path to be drawn inside another path, or more general: where you want points to touch instead of being overlaid.



We can achieve this by defining point `q` to be located on top of the midpoint.

```
pair q ; q := top .5[l1corner p, lrcorner p] ;
```

The predefined macro `top` moves the point over the distance similar to the current pen width.



Because we are dealing with two drawing operations, and since the path inside is drawn through the center of points, we need to repeat this move in order to draw the red path really inside the other one.

```
pair q ; q := top top .5[l1corner p, lrcorner p] ;
```

Operations like `top` and its relatives `bot`, `lft` and `rt` can be applied sequentially.

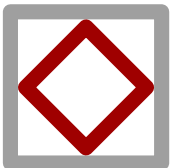

We already showed that `q` was defined as a series of rotations.

```
draw q -- q rotated 90 -- q rotated 180 --
      q rotated 270 -- cycle withcolor .625red ;
```

As an intermezzo we will show an alternative definition of `q`. Because each point is rotated 90 degrees more, we can define a macro that expands into the point and rotates afterwards. Because each consecutive point on the path is rotated an additional 90 degrees, we use the METAPOST macro `hide` to isolate the assignment. The `hide` command executes the hidden command and afterwards continues as if it were never there. You must not confuse this with grouping, since the hidden commands are visible to its surroundings.

```
def qq = q hide(q := q rotated 90) enddef ;
draw qq -- qq -- qq -- qq -- cycle withcolor .625red ;
```

The macro `top` uses the characteristics of the current pen to determine the displacement. However, for the more complicated pen shapes we need a different trick to get an inside path. Let's start by defining an elliptical path.

```
pickup pencircle xscaled 3mm yscaled 5mm rotated 30 ;
path p ; p := fullcircle xscaled 6cm yscaled 3cm ;
draw p withcolor .625white ;
```

We draw this path using a non standard pen. In the METAFONT manual you will find methods to draw shapes with similar pens, where the pen is also turning, as it does in real calligraphy. Here we stick to a more simple one.

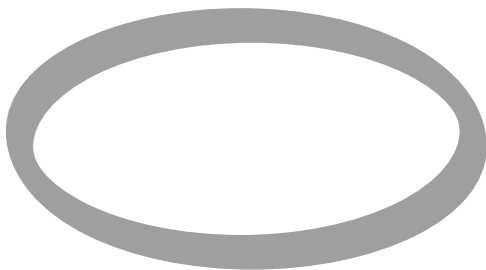

We construct the inner path from the points that make up the curve. Watch how we use a `for` loop to compose the new path. When used this way, no semi colon may be used to end the loop, since it would isolate the color directive.

```
draw point 0 of p
      for i=1 upto length(p) : -- point (i) of p endfor
      withcolor .625red ;
```

The points are still located on the original path.

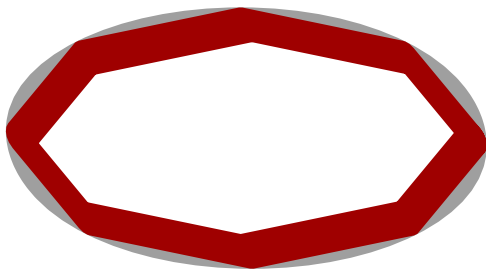

We can move the points to the inside by shifting them over the penwidth in the direction perpendicular to the point. Because we use this transformation more than once, we wrap it into a macro. This also keeps the code readable.

```
vardef inside expr pnt of p =
  (point pnt of p shifted
   -(penoffset direction pnt of p of currentpen))
enddef ;
draw inside 0 of p
  for i=1 upto length(p) : -- inside i of p endfor
  withcolor .625red ;
```

Whenever you define a pen, METAFONT stores its characteristics in some private variables which are used in the top and alike directives. The `penoffset` is a built in primitive and is defined as the “point on the pen furthest to the right of the given direction”. Deep down in METAFONT pens are actually simple paths and therefore METAFONT has a notion of a point on the penpath. In the METAFONT book and METAFONT manual you can find in depth discussions on pens.

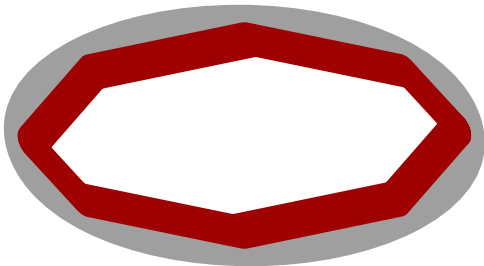

We’re still not there. Like in a previous example, we need to shift over twice the pen width. To get good results, we should determine the width of the pen at that particular point, which is not trivial. The more general solution, which permits us to specify the amount of shifting, is as follows.

```
vardef penpoint expr pnt of p =
  save n, d ; numeric n, d ;
  (n,d) = if pair pnt : pnt else : (pnt,1) fi ;
  (point n of p shifted
   ((penoffset direction n of p of currentpen) scaled d))
enddef ;
```

When the point specification is extended with a distance, in which case we have a pair expression, the point and distance are derived from this specification. First we demonstrate the simple case:

```
draw penpoint 0 of p
  for i=1 upto length(p)-1 : .. penpoint i of p endfor .. cycle
  withcolor .625red ;
```

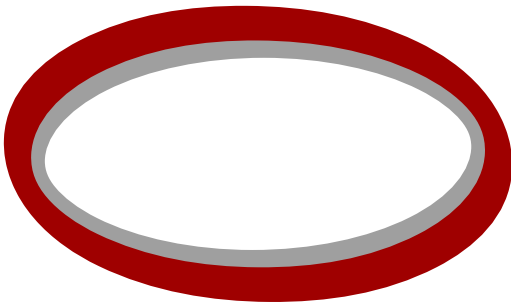

In the next graphic, we draw both an inner and an outer path.

```
draw penpoint (0,-2) of p
  for i=1 upto length(p)-1 : .. penpoint (i,-2) of p endfor .. cycle
  withcolor .625red ;
draw penpoint (0,+2) of p
  for i=1 upto length(p)-1 : .. penpoint (i,+2) of p endfor .. cycle
  withcolor .625yellow ;
```

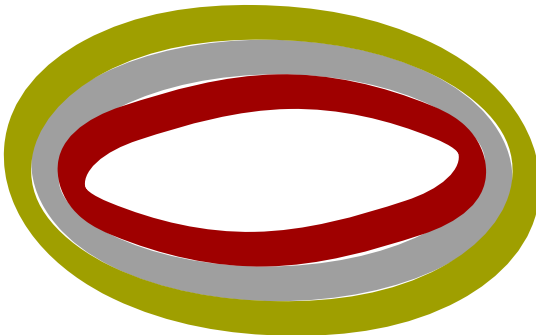

Another case when top and friends cannot be applied in a general way is the following. Consider the three paths:

```
path p, q, r ;
p := fullcircle scaled 3cm ;
q := p shifted (7cm,0cm) ;
r := center p -- center q ;
```

We draw these paths with:

```
draw p withpen pencircle scaled 10pt withcolor .625red ;
draw q withpen pencircle scaled 10pt withcolor .625yellow ;
draw r withpen pencircle scaled 20pt withcolor .625white ;
```

The line is drawn from center to center and since the line has a non zero width and a round line cap, it extends beyond this point.



If we want the line to stop at the circular paths, we can cut off the pieces that extend beyond those paths.

```
pair pr, qr ;
pr := p intersectionpoint r ;
qr := q intersectionpoint r ;
r := r cutbefore pr cutafter qr ;
```

This time we get:



Due to the thicker line width used when drawing the straight line, part of that line is still visible inside the circles. So, we need to clip off a bit more.

```
r := r cutbefore (point 5pt on r) ;
r := r cutafter (point -5pt on r) ;
```

The point ... on operation is a METAFUN macro that takes a dimension.



In order to save you some typing, METAFUN provides a macro cutends that does the same job:

```
r := r cutends 5pt ;
```

This time we draw the path in a different order:

```
draw r withpen pencircle scaled 20pt withcolor .625white ;
draw p withpen pencircle scaled 10pt withcolor .625red ;
```

```
draw q withpen pencircle scaled 10pt withcolor .625yellow ;
```

That way we hide the still remaining overlapping part of the line.



2.9 Directions

Quite often you have to tell METAPOST in what direction a line should be drawn. A direction is specified as a vector. There are four predefined vectors: `up`, `down`, `left`, `right`. These are defined as follows:

```
pair up, down, left, right ;
up = -down = (0,1) ; right = -left = (1,0) ;
```

We can use these predefined pairs as specifications and in calculations.

```
dotlabel.top("up" , up * 1cm) ;
dotlabel.bot("down" , down * 1cm) ;
dotlabel.lft("left" , left * 1cm) ;
dotlabel.rt ("right", right * 1cm) ;

drawoptions (withpen pencircle scaled .25mm withcolor .625 red) ;

drawarrow origin -- up * 1cm ;
drawarrow origin -- down * 1cm ;
drawarrow origin -- left * 1cm ;
drawarrow origin -- right * 1cm ;
```

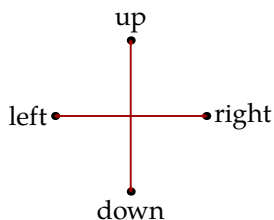

This graphic can also be defined in a more efficient (but probably more cryptic) way. The next definition demonstrates a few nice tricks. Instead of looping over the four directions, we loop over their names. Inside the loop we convert these names, or strings, into a pair by scanning the string using `scantokens`. The `freedotlabel` macro is part of `METAFUN` and takes three arguments: a label string (or alternatively a picture), a point (location), and the 'center of gravity'. The label is positioned in the direction opposite to this center of gravity.

```
pair destination ;
for wheretoto = "up", "down", "left", "right" :
  destination := scantokens(wheretoto) * 1cm ;
```

```

freedotlabel(wheret, destination, origin) ;
drawarrow origin -- destination
  withpen pencircle scaled .25mm withcolor .625 red ;
endfor ;

```

So, in this code fragment, we use the string as string and (by means of scantokens) as a point or vector.

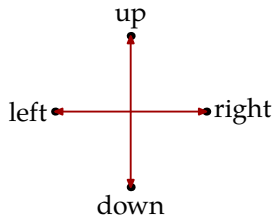

The previous definition is a stepping stone to the next one. This time we don't use points, but the dir command. This command converts an angle into an unitvector.

```

pair destination ;
for wheret = 0 step 30 until 330 :
  destination := dir(wheret) * 1.5cm ;
  freedotlabel(decimal wheret, destination, origin) ;
  drawarrow origin -- destination
    withpen pencircle scaled .25mm withcolor .625 red ;
endfor ;

```

In METAPOST the angles go counter clockwise, which is not that illogical if you look at it from the point of view of vector algebra.

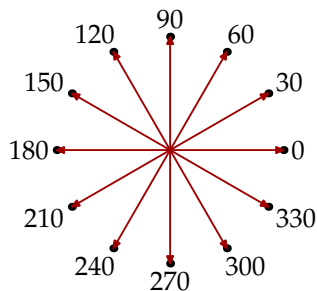

2.10 Analyzing pictures

Unless you really want to know all details, you can safely skip this section. The METAPOST features discussed here are mainly of importance when you write (advanced) macros.

We can decompose METAPOST pictures using a within loop. You may wonder if such a within loop construct has any real application, and as you can expect, it has. In section 13.4 a macro is defined that draws a colored circle. If you want the inverted alternative, you can pass the inverted color specification, but wouldn't it be more convenient if there was an operator that did this for you automatically? Unfortunately there isn't one so we have to define one ourselves in a macro.

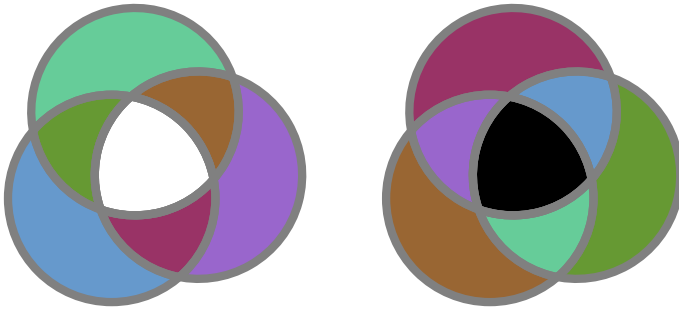

These circles were drawn using:

```
colorcircle(4cm,(.4,.6,.8),(.4,.8,.6),(.6,.4,.8)) ;
addto currentpicture also inverted currentpicture shifted (5cm,0) ;
```

When we draw a path, or stroke a path, as it is called officially, we actually perform an addition:

```
addto currentpicture doublepath somepath
```

The fill command is actually:

```
addto currentpicture contour somepath
```

We will need both `doublepath` and `contour` operations in the definition of `inverted`.

When METAPOST has digested a path into a picture, it keeps track of some characteristics. We can ask for them using `part...` operators. The following operators can be applied to a transform vector (one of METAPOST's data types), but also to a picture. Say that we have drawn a circle:

```
draw fullcircle
  xscaled 3cm yscaled 2cm
  dashed dashpattern(on 3mm off 3mm)
  withpen pencircle scaled 1mm
  withcolor .625red ;
picture p ; p := currentpicture ;
```

This circle looks like:

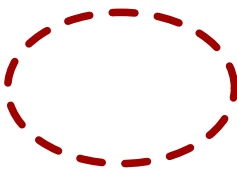

We can now ask for some of the characteristics of `currentpicture`, like its color. We could write the values to the log file, but it is more convenient to put them on paper.

```
label.rt("redpart: " & decimal redpart p, (4cm,+ .5cm)) ;
label.rt("greenpart: " & decimal greenpart p, (4cm, 0cm)) ;
label.rt("bluepart: " & decimal bluepart p, (4cm,- .5cm)) ;
```

Here the `&` glues strings together, while the decimal operator converts a number into a string.

The result has no typographic beauty—keep in mind that here we use METAPOST to typeset the text—but the result serves its purpose.

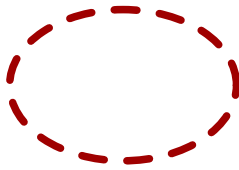

```
redpart: 0.625
greenpart: 0
bluepart: 0
```

We can also ask for the path itself (`pathpart`), the pen (`penpart`) and the dashpattern (`dashpart`), but these can only be assigned to variables of the corresponding type.

A path can be stroked or filled, in which case it is a cyclic path. It can have a non natural bounding box, be a clip path, consist of line segments or contain text. All these characteristics can be tested.

```
label.rt("filled: " & condition filled      p, (4cm,+1.25cm)) ;
label.rt("stroked: " & condition stroked     p, (4cm,+0.75cm)) ;
label.rt("textual: " & condition textual     p, (4cm,+0.25cm)) ;
label.rt("clipped: " & condition clipped     p, (4cm,-0.25cm)) ;
label.rt("bounded: " & condition bounded    p, (4cm,-0.75cm)) ;
label.rt("cycle: " & condition cycle pathpart p, (4cm,-1.25cm)) ;
```

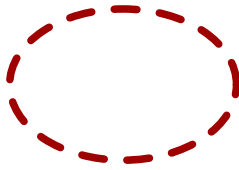

```
fi
stroked: true
textual: false
clipped: false
bounded: false
cycle: true
```

In this code snippet, `condition` is a macro that takes care of translating a boolean value into a string (like `decimal` does with a numeric value).

```
def condition primary b =
  if b : "true" else : "false" fi
enddef ;
```

Clip paths and bounding boxes are kind of special in the sense that they can obscure components. The following examples demonstrate this. In case of a clip path or bounding box, the `pathpart` operator returns this path. In any case that asking for a value does not make sense—a clipping path for instance has no color—a zero (null) value is returned.

```
draw      fullcircle withpen pencircle scaled 6mm ;
clip      currentpicture to fullcircle ;
setbounds currentpicture to fullcircle ;
```

```
n: 2 / length: 1 / stroked: false / clipped: true / bounded: false
```

```
draw      fullcircle withpen pencircle scaled 6mm ;
setbounds currentpicture to fullcircle ;
clip      currentpicture to fullcircle ;
```

```
n: 2 / length: 1 / stroked: false / clipped: false / bounded: true
```



```
clip      currentpicture to fullcircle ;
draw      fullcircle withpen pencircle scaled 6mm ;
setbounds currentpicture to fullcircle ;
```



```
n: 2 / length: 0 / stroked: false / clipped: true / bounded: false
n: 3 / length: 1 / stroked: true / clipped: false / bounded: false
```

```
clip      currentpicture to fullcircle ;
setbounds currentpicture to fullcircle ;
draw      fullcircle withpen pencircle scaled 6mm ;
```



```
n: 2 / length: 1 / stroked: false / clipped: false / bounded: true
n: 3 / length: 1 / stroked: true / clipped: false / bounded: false
```

```
setbounds currentpicture to fullcircle ;
clip      currentpicture to fullcircle ;
draw      fullcircle withpen pencircle scaled 6mm ;
```



```
n: 2 / length: 1 / stroked: false / clipped: true / bounded: false
n: 3 / length: 1 / stroked: true / clipped: false / bounded: false
```

```
setbounds currentpicture to fullcircle ;
draw      fullcircle withpen pencircle scaled 6mm ;
clip      currentpicture to fullcircle ;
```

```
n: 2 / length: 0 / stroked: false / clipped: false / bounded: true
n: 3 / length: 1 / stroked: true / clipped: false / bounded: false
```

The description lines were generated by the following loop:

```
n := 1 ;
for i within currentpicture : n := n + 1 ;
  label("n: " & decimal n & " / " &
    "length: " & decimal length i & " / " &
    "stroked: " & condition stroked i & " / " &
    "clipped: " & condition clipped i & " / " &
    "bounded: " & condition bounded i , (0,-n*.5cm)) ;
endfor ;
```

The textual capabilities built in METAPost are rather limited but in CONTEXT we have overloaded the relevant operators. There we hook into the normal font handler. The native text related operators are:

```
draw "MetaFun" infont "somefont" scaled 2 rotated 30 slanted .5 ;
```

```
draw btex MetaFun etex scaled 2 rotated 30 slanted .5 ;
```

The `infont` operator directly calls for a font and in stock METAPOST is limited to (eight bit) TYPE1 fonts. In `CONTEXT` you can do this:

```
draw "MetaFun" infont "SerifBold*default" xscaled 5 rotated 5 slanted .5 ;
```

The specification is a regular `CONTEXT` font specification.

MetaFun

The `btex ... etex` variant in normal METAPOST delegates to `TEX` and in MKII indeed we filter them and process them between runs (or at runtime). In MKIV they are also handled by `TEX` but in an even more integrated and immediate way.

The two primitives `textpart` and `fontpart` that can be used to disassemble a picture don't apply to METAFUN as contrary to METAPOST we don't convert the result to a picture. In later chapters we will discuss text in more detail.

From the previous examples it may be clear that each picture has some associated data stored with it. From the bounded boolean test we can conclude that the bounding box is part of this data. Internally METAPOST keeps track of two bounding boxes: the natural one, and the forced one. The forced one is actually a component of the picture which applies to all previously added graphics. You can calculate the bounding box from the `llcorner` and `urcorner` or if you like `ulcorner` and `lrcorner` and the METAFUN command `boundingbox` does so.

The four corners that make up the bounding box are either the natural ones, or the ones forced by `setbounds`. You can force METAPOST to report the natural ones by setting `truecorners` to 1. The next example demonstrates this feature.

```
pickup pencircle scaled 2mm ; path p, q ;
draw fullcircle
  scaled 4cm slanted .5 withcolor .625white ;
setbounds currentpicture to
  boundingbox currentpicture enlarged -5mm ;
interim truecorners := 0 ; p := boundingbox currentpicture ;
interim truecorners := 1 ; q := boundingbox currentpicture ;
pickup pencircle scaled 1mm ;
draw p withcolor .625red ;
draw q withcolor .625yellow ;
```

We use `interim` because `truecorners` is an internal METAPOST variable.

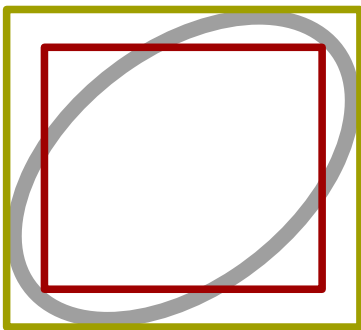

2.11 Filling

In most cases a path ends up being drawn or filled. When filling a path, it doesn't matter in what direction the path runs, as long as it's closed you're fine. You can however change the direction any time along the path. Here is an example of what happens when you fill a path that is partially reversed.

```
fill fullsquare rotated 45 scaled 2cm
  withcolor .625 red ;
fill fullcircle scaled 2cm -- reverse fullcircle scaled 1cm -- cycle
  withcolor .625 yellow ;
```

You'll notice that the inner circle is not filled:

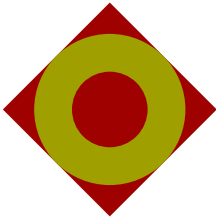

Now watch the following:

```
fill
  fullsquare rotated 45 scaled 2cm
  -- fullcircle scaled 2cm
  -- cycle
  withcolor .625 red ;
```

This results in:

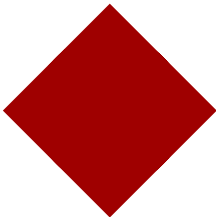

Compare this with:

```
fill
  fullsquare rotated 45 scaled 2cm
  -- reverse fullcircle scaled 2cm -- cycle
  -- cycle
  withcolor .625 red ;
```

giving:

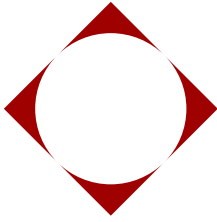

The normal filling happens according to the non-zero winding rule. An alternative is the odd-even rule. There we don't need the reverse trick:

```
eofill fullsquare rotated 45 scaled 2cm
-- fullcircle scaled 2cm -- cycle
withcolor .625 red ;
```

The `eofill` is a METAFUN extension. Hopefully the next explains a bit how this works (you can find explanations on the internet).

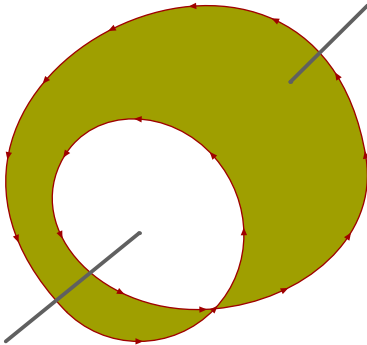
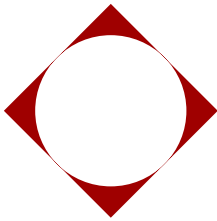

`eofill`

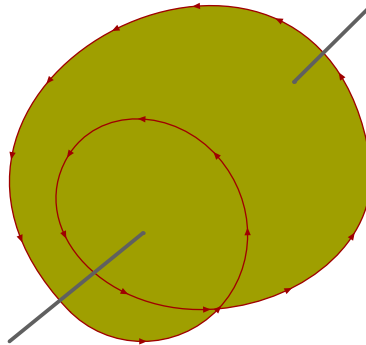

`fill`

In the case of a normal fill, the non-zero winding rule is applied: a winding number is calculated by subtracting 1 each time the line (from inside an area to someplace outside) is crossed clockwise while 1 is added each time we cross anti-clockwise. When the total is non zero the area is filled. Here we run in one direction and therefore we always get a fill. In the previous example where we used a reverse, an anti-clockwise crossing was nulled by a clockwise one.

The leftmost shape uses `eofill` and therefore the odd-even rule gets applied. This time we follow the line and when it gets crossed an even number of times the area will not be filled.

A glyph is often constructed from more than one path and eventually the shape is filled with an odd-even fill (`eofill`) operation. Take the following sequence:

```
pickup pencircle scaled 1mm ;
draw fullsquare scaled 2cm ;
draw fullsquare scaled 2cm shifted (1cm,0) ;
```

```
draw fullsquare scaled 2cm shifted (0,1cm) ;
```

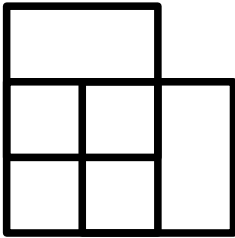

We can use a sequence of `nofill` ending with a `eofill` to create a combined shape. This is not done in METAPOST but in the backend.

```
nofill fullsquare scaled 2cm ;
nofill fullsquare scaled 2cm shifted (1cm,0) ;
eofill fullsquare scaled 2cm shifted (0,1cm) ;
```

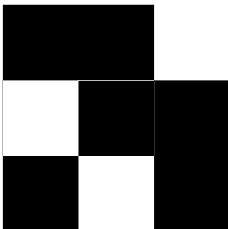

As this is used for glyphs, we demonstrate this mechanism with a simple 0 shape:

```
nofill fullcircle xyscaled (2cm,3cm) ;
eofill fullcircle xyscaled (1cm,2cm) ;
```

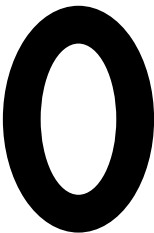

Another backend related feature is `fillup`. This is just a combination of a fill and a draw in one go. It can save some bytes in the output file.

```
draw image (
  pickup pencircle scaled 5mm ;
  fill fullsquare scaled 2cm ;
  draw fullsquare scaled 2cm ;
  fillup fullsquare scaled 2cm shifted (4cm,0) ;
) withcolor .625red ;
```

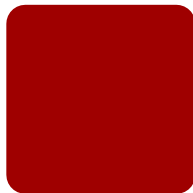
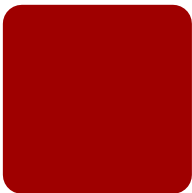

2.12 Pitfalls

When writing macros, you need to be careful in what operations apply to what object. There is for instance a difference between the following code:

```
pickup pencircle scaled 2pt ;
draw (0,0)--(0,1)--(1,1) scaled 1cm withcolor .625 red ;
draw ((0,0)--(0,1)--(1,1)) scaled 2cm withcolor .625 yellow ;
```

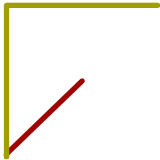

The scaled operates on the previous expression which in the first case is the point (1,1) and in the second case the whole path.

```
pickup pencircle scaled 2pt ;
draw (0,0)--(0,1)--(1,1)--cycle scaled 1cm withcolor .625 red ;
draw ((0,0)--(0,1)--(1,1)--cycle) scaled 2cm withcolor .625 yellow ;
```

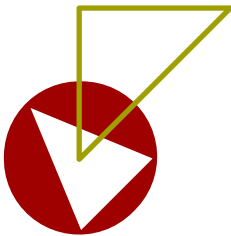

Here the last element in the first case is not the cycle, and the next alternative does not help us much in discovering what is going on. (Well, at least something *is* going on, because the result seems to have some dimensions.)

```
pickup pencircle scaled 2pt ;
draw (1,1)--cycle scaled 1cm withcolor .625 red ;
draw ((1,1)--cycle) scaled 1cm withcolor .625 yellow ;
```

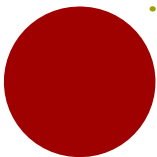

The next lines demonstrate that we're dealing with the dark sides of METAPOST, and from that we may conclude that in case of doubt it's best to add parenthesis when such fuzzy situations threaten to occur.

```
pickup pencircle scaled 2pt ;
draw (0,1)--(1,1)--cycle scaled 1cm withcolor .625 red ;
draw ((0,1)--(1,1)--cycle) scaled 1cm withcolor .625 yellow ;
```

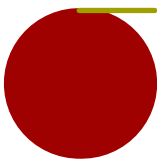

There are more cases where the result may surprise you. Take the following code:

```
drawarrow ((0,0)--(10,0))
  withpen pencircle scaled 2pt
  withcolor red randomized (.4,.9) ;
currentpicture := currentpicture scaled 8 ;
```

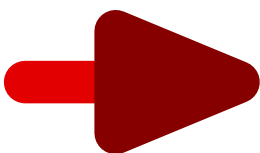

The arrow is made up out of two pieces and each piece gets a different shade of red. This is because the attributes are collected and applied to each of the components that make up the arrow. Because for each component the attribute code is expanded again, we get two random colors. One way around this is to apply the color afterwards.

```
draw
  image (drawarrow ((0,0)--(10,0)) withpen pencircle scaled 2pt)
  scaled 8 withcolor red randomized (.4,.9) ;
```

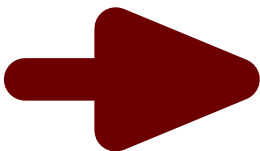

Here the image macro creates a picture and as you can see, this provides a way to draw within a draw operation.

Once you see the benefits of `image`, you will use it frequently. Another handy (at first sight strange) macro is `hide`. You can use this in situations where you don't want code to interfere.

```
def mydraw text t =
  boolean error ; error := false ;
  def withpencil expr p = hide (error := true) enddef ;
  draw t ;
  if error : message "pencils are not supported here" fi ;
enddef ;
mydraw fullcircle scaled 10cm withpencil sharp ;
```

Here, setting the boolean normally interferes with the draw operation, but by hiding the assignment, this code becomes valid. This code will bring the message to your terminal and log file.

Once you start using expressions you have a good chance of encountering messages with regard to redundant expressions. The following code is for instance a recipe for problems:

```
z1 = (1,0) ; z1 = (2,0) ;
```

Changing the = into := helps, but this may not be what you want.

Because the z-variables are used frequently, they are reset each figure. You can also reset them yourself, using the `clearxy` macro. The METAFUN version clears all z-variables, unless you explicitly specify what variables to reset.⁷ If you want to play with this macro, see what happens when you run the following code:

```
show x0 ; z0 = (10,10) ;
show x0 ; x0 := whatever ; y0 := whatever ;
show x0 ; z0 = (20,20) ;
show x0 ; clearxy 0 ;
show x0 ; z0 = (30,30) ;
```

So, the following calls are all legal:

```
clearxy ; clearxy 1 ; clearxy 1, 8, 10 ;
```

Keep in mind that for each figure a full clear is done anyway. You should not confuse this command with `clearit`, which clears `currentpicture`.

2.13 T_EX versus MetaPost

If you are defining your own T_EX and METAPOST macros, you will notice that there are a couple of essential differences between the two macro languages. In T_EX the following code is invalid.⁸

```
\def\fancyplied#1%
  {\ifnum#1=0
    \message{zero argument}%
    \fi
    \count0=#1 \multiply \count0 by \count0
    \count2=#1 \multiply \count2 by 2
    \count4=#1 \divide \count4 by 2
    \advance \count0 by \count2
    \advance \count0 by \count4
    \count4 }
\hskip \fancyplied{3} pt
```

This is because T_EX is very strict in what tokens it expects next. In METAPOST however, you can use `vardef'd` macros to hide nasty intermediate calculations.

```
vardef fancyplied expr x =
  if x=0 : message "x is zero" ; (x*x+2x+x/2)
enddef ;
a := a shifted (fancyplied 3pt,0) ;
```

Hiding intermediate calculations and manipulations is a very strong point of METAPOST.

Another important difference between both languages is the way grouping is implemented. Because T_EX is dealing with a flow of information, strong grouping is a must and therefore part of

⁷ This version resulted from a discussion on the METAFONT discussion list and is due to Bogusław Jackowski.

⁸ In ϵ -T_EX the calculation can be done in less lines using a `\numexpr`.

the language. Occasionally you run into situations where you wished that you could reach over a group (for instance in order to pass a value).

In METAPOST grouping behaves quite different. First of all, it provides the mechanism that hides processing from the current flow. The previously mentioned `vardef` is implicitly grouped. Contrary to \TeX , in METAPOST all assignments are global by default, even in a group. If you assign a variable inside a group it is persistent unless you first save the variable (or macro) using the `save` operator.

So, in the next code snippet, the value of `\value` inside the box is *no* but after the box is typeset, it will be *yes* again.

```
\def\value{yes} \hbox{\def\value{no}\value} \value
```

To make a value local in METAPOST, the following code is needed.

```
string value ; value := "yes" ;
def intermezzo
  begingroup ;
  save value ; string value ; value := "no" ;
  endgroup ;
enddef ;
```

Once you start writing your own METAPOST macros, you will appreciate this ‘always global’ behaviour. As with other differences between the two languages, they make sense if you look at what the programs are supposed to do.

2.14 Internals and Interims

Related to grouping is the internal numeric datatype. When numeric variables are defined as interim, you can quickly overload them inside a group.

```
newinternal mynumber ; mynumber := 1 ;
begingroup ; ... interim mynumber := 0 ; ... ; endgroup ;
```

You can only interim a variable if it is already defined using `newinternal`.

Among the METAPOST macros is one called `drawdot`. This macro is kind of redundant because, at least at first sight, you can use `draw` to achieve the same result. There is however a very subtle difference: a dot is slightly larger than a drawn point. We guess that it’s about the device pixel, so you may not even notice it. It may even be due to differences in accuracy of the methods to render them.

```
pickup pencircle scaled 50pt ;
drawdot origin shifted (-120pt,0) ; draw origin shifted (-60pt,0) ;
drawdot origin ; draw origin withcolor white ;
setbounds currentpicture to boundingbox currentpicture enlarged 1pt ;
```

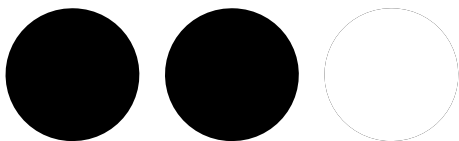

2.15 Named colors

The `withcolor` operator accepts a color expression but in METAFUN it also accepts a string indicating a color defined at the \TeX end. Most helpers that deal with colors are able to deal with named colors as well. Here are some examples. First we define a few colors:

```
\definecolor [MyColor1] [r=.5]
\definecolor [MyColor2] [g=.5]
\definecolor [MyColor3] [b=.5]
\definecolor [MyColor4] [s=.8]
```

Here we access them:

```
fill fullcircle scaled 12 withcolor "MyColor1" ;
fill fullcircle scaled 10 withcolor "MyColor2" ;
fill fullcircle scaled 8 withcolor complementary "MyColor3" ;
fill fullcircle scaled 6 withcolor complemented "MyColor3" ;
fill fullcircle scaled 4 withcolor "MyColor4" randomized 2 ;
fill fullcircle scaled 2 withcolor "MyColor4" randomized 2 ;
addbackground
  withcolor .5[resolvedcolor("MyColor4"),resolvedcolor("MyColor2")] ;
currentpicture := currentpicture ysize 4cm ;
```

And get:

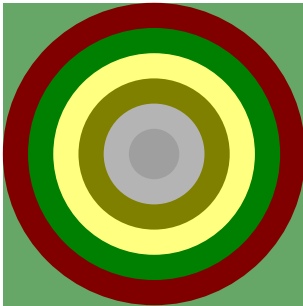

2.16 Formatted text

Text support in METAFUN has evolved quite a bit over years. For compatibility reasons we keep old methods around but in practice one can probably do all with the following:

```
texttext [.anchor] (str)      position a text relative to the origin
thetexttext [.anchor] (str, pos) position a text relative to the given position
rawtexttext [.anchor] (str, pos) idem but with less checking
```

If needed all functionality could be combined in one call (`texttext`) but we keep it this way.

You need to keep in mind that text in METAFUN is not a first class object but something virtual that is known to METAFUN as something with path like properties but is actually dealt with in the backend. This means that timing is important.

```
\startMPinitializations
picture p ; p := image(draw texttext("Foo"));
```

```

\stopMPinitializations

\startMPcode
  picture q ; q := image(draw texttext("Bar"));
  picture r ; r := image(draw texttext("Gnu"));
  draw p ;
  draw q shifted (2cm,0) ;
  draw r shifted (4cm,0) ;
\stopMPcode

```

This will work out well because an initialization is part of a figure, but this will fail:

```

\startMPinclusions
picture p ; p := image(draw texttext("Foo"));
\stopMPinclusions

```

because inclusions happen before the local texttexts get initialized and due to the multipass implementation are not seen a second time. The order of processing is:

action	first pass	second pass
definitions	yes	
extensions	yes	
inclusions	yes	
begin figure	yes	yes
initializations	yes	yes
metapost code	yes	yes
end figure	yes	yes

The graph package (that comes with METAPOST) has some pseudo typesetting on board needed to format numbers. Because we don't want to interfere with the definitions of macros used in that package we provide another set of macros for formatting: `fmmtext`, `thefmtext` and `rawfmmtext`.

```

\startMPcode
draw thefmmtext("\bf@3.2f done",123.45678) withcolor darkred ;
\stopMPcode

```

Here we pass one variable to the format but there can be more: **123.46 done**. In LUA the % is used as format directive but that does not work well in T_EX and LUA which is why we use @ instead. The formatting is done with the formatters subsystem which is an extension to the regular LUA format function. More information can be found in `clf-mkiv.pdf` but one extension is not mentioned there: `%!texexp!`. This directive takes one argument by default but optionally can take one or two extra arguments: the format of the base number and one for the exponent. The following code demonstrates this:

```

\startMPcode{doublefun}
draw image (
  draw thefmmtext.rt("@!texexp!", 10.4698E30, (0,-1LineHeight)) ;
  draw thefmmtext.rt("@1!texexp!",10.4698E30, (0,-2LineHeight)) ;
  draw thefmmtext.rt("@2!texexp!",10.4698E30,"@2.3f", (0,-3LineHeight)) ;
  draw thefmmtext.rt("@3!texexp!",10.4698E30,false,"@2i", (0,-4LineHeight)) ;
  draw thefmmtext.rt("@3!texexp!",10.4698E30,"@2.3f","@2i", (0,-5LineHeight)) ;
) withcolor darkblue ;

```

```
\stopMPcode
```

We switch to double mode because we use large numbers.

```
1.046980 × 1031
1.046980 × 1031
1.047 × 1031
1.046980 × 1031
1.047 × 1031
```

Of course this extra formatter is also supported in the context command:

```
\startluacode
context("%!texexp!, ", 10.4698E30)
context("%1!texexp!, ", 10.4698E30)
context("%2!texexp!, ", 10.4698E30,"@2.3f")
context("%3!texexp! and ",10.4698E30,false,"@2i")
context("%3!texexp!", 10.4698E30,"@2.3f","@2i")
\stopluacode
```

This gives: 1.046980×10^{31} , 1.046980×10^{31} , 1.047×10^{31} , 1.046980×10^{31} and 1.047×10^{31} .

2.17 Lists (aka suffixed variables)

Sometimes graphics are constructed using lists. There are a few helpers (and maybe there will be some more) that can make things a bit easier. Say that we do this:

```
pair a[] ;
a[1] := (0,0) ; a[2] := (1,0) ;
a[3] := (1,1) ; a[4] := (0,1) ;
a[5] := (1,1) ; a[6] := (2,0) ;

draw topath(a,--) ysize 2cm
  withpen pencircle scaled 1mm
  withcolor .625red ;
```

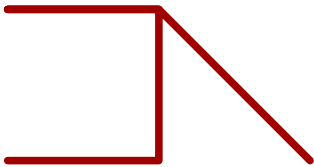

The topath macro converts the list into a path, in this case an ugly one.

Say that we want to get rid of the sixth entry. For that we can use the dispose macro. You can use the dispose for any type (except a macro).

```
dispose(a[6]) ;
draw topath(a,--) ysize 2cm
  withpen pencircle scaled 1mm
  withcolor .625yellow ;
```

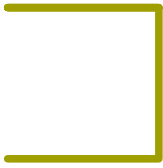

We still have some duplicate entries here:

```
dispose(a[6]) ;
drawpoints topath(a,--) ysize 2cm
  withpen pencircle scaled 1mm
  withcolor .625red ;
drawpointlabels topath(a,--) ysize 2cm ;
```



These can be removed with:

```
uniquelist(a) ;
draw topath(a,--) ysize 2cm
  withpen pencircle scaled 1mm
  withcolor .625yellow ;
drawpoints topath(a,--) ysize 2cm
  withpen pencircle scaled 1mm
  withcolor .625red ;
drawpointlabels topath(a,--) ysize 2cm ;
```

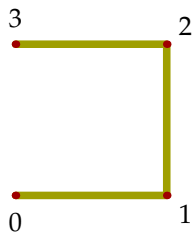

Sometimes a list needs to be sorted and here is the solution:

```
sortlist(a,nothing) ;
draw topath(a,--) ysize 2cm
  withpen pencircle scaled 1mm
  withcolor .625red ;
```



The second argument can be an operator that takes a pair variable:

```
sortlist(a,xpart) ;
draw topath(a,--) ysize 2cm
  withpen pencircle scaled 3mm
  withcolor .625red ;
sortlist(a,ypart) ;
draw topath(a,--) ysize 2cm
  withpen pencircle scaled 2mm
  withcolor .625yellow ;
```



Constructing a list can be sped up with the `tolist` macro.

```
pair a[], b[], c[], d[] ;
tolist(a,1,(0,0),(1,0),(1,1),(0,1)--(1,1)--(2,2)) ;
tolist(b,0,(0,0),(1,0),(1,1),(0,1)--(1,1)--(2,2)) ;
tolist(c,(0,0),(1,0),(1,1),(0,1)--(1,1)--(2,2)) ;
tolist(d,(0,0),(1,0),(1,1)) ;

draw image (
  draw topath(a,--) shifted (0,0) ;
  draw topath(b,--) shifted (3,0) ;
  draw topath(c,--) shifted (6,0) ;
  draw topath(d,--) shifted (9,0) ;
) ysize 2cm withpen pencircle scaled 1mm withcolor .625red ;
```

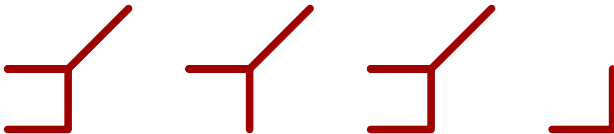

2.18 Segmented paths

There are all kind of helpers in METAFUN and some are discussed here. In figure 2.7 we see a few macros that return a (smooth) path made from segments. You can for instance use these to do things that use the points on a path, like anchoring text.

```
def DrawSomePath(text t) =
  drawpath      t withcolor .625red ;
  drawpoints    t withcolor white ;
  drawpointlabels t ;
enddef ;

DrawSomePath(circularpath(5) scaled 12cm) ;
DrawSomePath(squarepath (5) scaled 8cm) ;
DrawSomePath(linearpath (5) scaled 4cm) ;
```

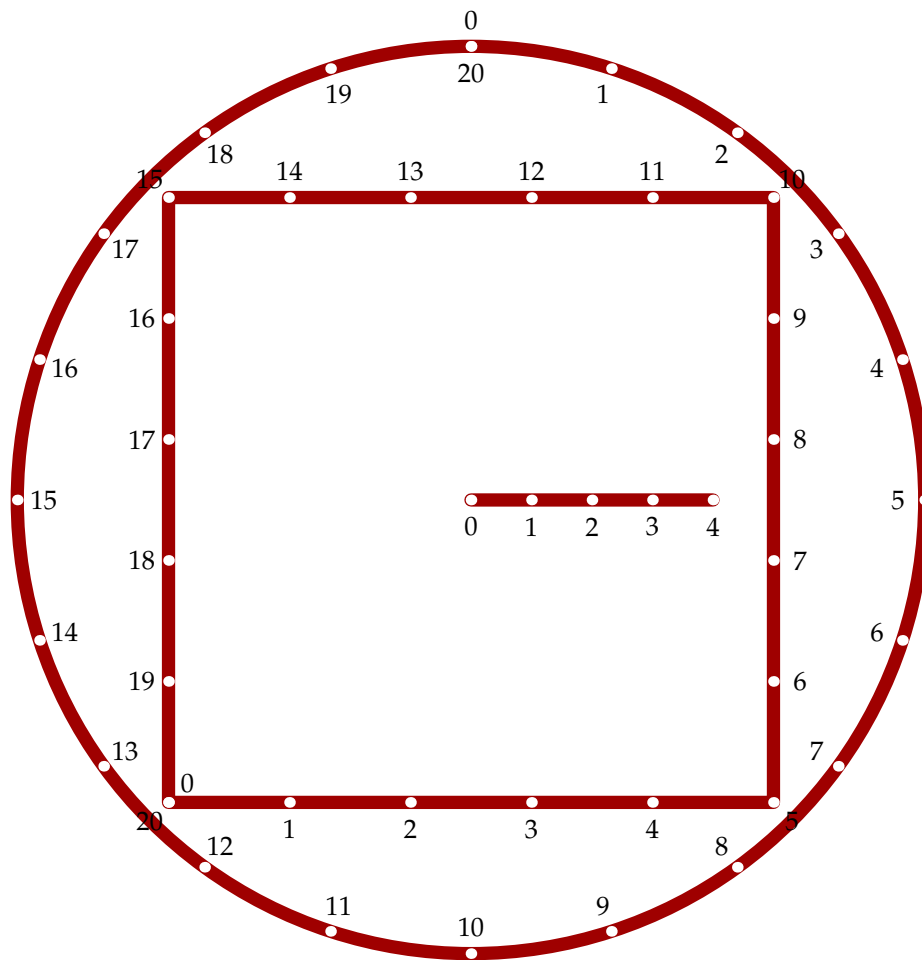

Figure 2.7 A few segmented paths.

The following examples demonstrates two mechanisms. In the image two paths are drawn on top of each other but one of them has holes where the other one crosses. The `crossingunder` macro was written by Alan Braslau as part of the node based diagram builder. In the process the arrow drawing code was adapted to accept a picture.

```
drawarrow image (
  draw ((fullcircle scaled 2.25cm) crossingunder (fullsquare scaled 2cm))
    withpen pencircle scaled 1mm withcolor .625green ;
  draw (fullsquare scaled 2cm)
    withpen pencircle scaled 1mm withcolor .625blue ;
) ;
drawarrow image (
  draw (fullsquare scaled 4cm)
    withpen pencircle scaled 1mm withcolor .625red ;
  draw ((fullcircle scaled 5cm) crossingunder (fullsquare scaled 4cm))
    withpen pencircle scaled 1mm withcolor .625yellow ;
) ;
```

The next variant uses a different order:

```

drawarrow image (
  draw ((fullsquare scaled 2cm) crossingunder (fullcircle scaled 2.25cm))
    withpen pencircle scaled 1mm withcolor .625blue ;
  draw (fullcircle scaled 2.25cm)
    withpen pencircle scaled 1mm withcolor .625green ;
) ;
drawarrow image (
  draw (fullcircle scaled 5cm)
    withpen pencircle scaled 1mm withcolor .625yellow ;
  draw ((fullsquare scaled 4cm) crossingunder (fullcircle scaled 5cm))
    withpen pencircle scaled 1mm withcolor .625red ;
) ;

```

The results are shown in figure 2.8. The internal variable `crossingscale` can be used to make the gap wider or narrower. The gap has a default value of 20.

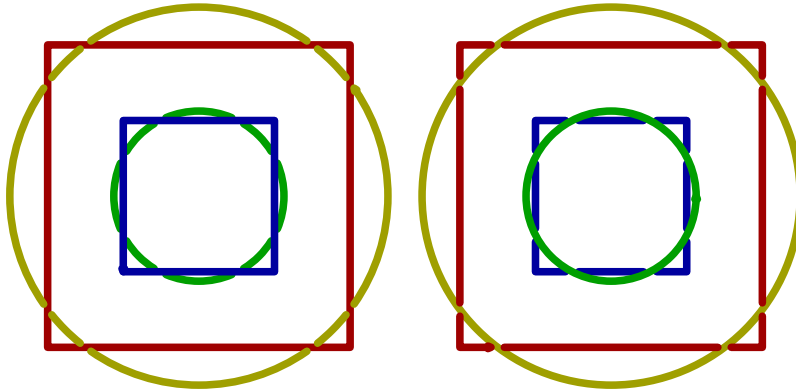

Figure 2.8 Crossing paths without touching

3 Embedded graphics

In addition to the `beginfig–endfig` method, there are other ways to define and include a METAPOST graphic. Each method has its advantages and disadvantages.

In the previous chapter we were still assuming that the graphic was defined in its own file. In this chapter we will introduce the interface between CONTEXT and METAPOST and demonstrate how the definitions of the graphics can be embedded in the document source.

3.1 Getting started

From now on, we will assume that you have CONTEXT running on your platform. Since PDF has full graphics support, we also assume that you use L^AT_EX in combination with CONTEXT MKIV, although most will also work with other engines and MKII. Since this document is not meant as a CONTEXT tutorial, we will limit this introduction to the basics needed to run the examples.

A simple document looks like:

```
\starttext
  Some text.
\stoptext
```

You can process this document with the LUA based command line interface to CONTEXT. If the source code is embedded in the file `mytext.tex`, you can say:

```
context mytext
```

We will use color, and in MKIV color is enabled by default. If you don't want color you can tell CONTEXT, so

```
\setupcolors[state=stop]
\starttext
  Some \color[blue]{text} and/or \color[green]{graphics}.
\stoptext
```

comes out in black and white.

In later chapters we will occasionally see some more CONTEXT commands show up. If you want to know more about what CONTEXT can do for you, we recommend the beginners manual and the reference manual, as well as the wiki pages.

3.2 External graphics

Since T_EX has no graphic capabilities built in, a graphic is referred to as an external figure. A METAPOST graphic often has a number as suffix, so embedding such a graphic is done by:

```
\externalfigure[graphic.123][width=4cm]
```

An alternative method is to separate the definition from the inclusion. An example of a definition is:

```
\useexternalfigure[pentastar][star.803][height=4cm]
```

```
\useexternalfigure[octostar] [star.804] [pentastar]
```

Here, the second definition inherits the characteristics from the first one. These graphics can be summoned like:

```
\placefigure
  {A five||point star drawn by \METAPOST.}
  {\externalfigure[pentastar]}
```

Here the stars are defined as stand-alone graphics, in a file called `star.mp`. Such a file can look like:

```
def star (expr size, n, pos) =
  for a=0 step 360/n until round(360*(1-1/n)) :
    draw (origin -- (size/2,0))
      rotatedaround (origin,a) shifted pos ;
  endfor ;
enddef ;

beginfig(803) ;
  pickup pencircle scaled 2mm ; star(2cm,5,origin) ;
endfig ;

beginfig(804) ;
  pickup pencircle scaled 1mm ; star(1cm,8,origin) ;
  pickup pencircle scaled 2mm ; star(2cm,7,(3cm,0)) ;
endfig ;

end.
```

This star macro will produce graphics like:



But, now that we have instant METAPOST available in L^AT_EX, there is no need for external images and we can collect them in libraries, as we will see later on.

3.3 Integrated graphics

An integrated graphic is defined in the document source or in a style definition file. The most primitive way of doing this is just inserting the code:

```
\startMPcode
  fill fullcircle scaled 200pt withcolor .625white ;
\stopMPcode
```

Such a graphic is used once at the spot where it is defined. In this document we also generate graphics while we finish a page, so there is a good chance that when we have constructed a graphic which will be called on the next page, the wrong graphic is placed.

For this reason there are more convenient ways of defining and using graphics, which have the added advantage that you can predefine multiple graphics, thereby separating the definitions from the usage.

The first alternative is a *usable* graphic. Such a graphic is calculated anew each time it is used. An example of a usable graphic is:

```
\startuseMPgraphic{name}
  fill fullcircle scaled 200pt withcolor .625yellow ;
\stopuseMPgraphic
```

When you put this definition in the preamble of your document, you can place this graphic anywhere in the file, saying:

```
\useMPgraphic{name}
```

As said, this graphic is calculated each time it is placed, which can be time consuming. Apart from the time aspect, this also means that the graphic itself is incorporated many times. Therefore, for graphics that don't change, `CONTEXT` provides *reusable* graphics:

```
\startreusableMPgraphic{name}
  fill fullcircle scaled 200pt withcolor .625yellow;
\stopreusableMPgraphic
```

This definition is accompanied by:

```
\reuseMPgraphic{name}
```

Imagine that we use a graphic as a background for a button. We can create a unique and reusable graphic by saying:

```
\def\MyGraphic
  {\startreusableMPgraphic{name:\overlaywidth:\overlayheight}
    path p ; p := unitsquare
      xscaled OverlayWidth yscaled OverlayHeight ;
    fill p withcolor .625yellow ;
    draw p withcolor .625red ;
    \stopreusableMPgraphic
    \reuseMPgraphic{name:\overlaywidth:\overlayheight}}
```

Notice the use of `OverlayWidth` and `OverlayHeight`. These variables are set for each call to `METAPOST`. After this we can say:

```
\defineoverlay[my graphic][\MyGraphic]
\button[background=my graphic,frame=off]{Go Home}[firstpage]
```

Say that we have a 30pt by 20pt button, then the identifier will be `name:30pt:20pt`. Different dimensions will lead to other identifiers, so this sort of makes the graphics unique.

We can bypass the ugly looking `\def` by using a third class of embedded graphics, the *unique* graphics.

```
\startuniqueMPgraphic{name}
  path p ; p := unitsquare
    xscaled OverlayWidth yscaled OverlayHeight ;
  fill p withcolor .625yellow ;
  draw p withcolor .625red ;
\stopuniqueMPgraphic
```

Now we can say:

```
\defineoverlay[my graphic][\uniqueMPgraphic{name}]
\button[background=my graphic,frame=off]{Go Home}[firstpage]
```

A shorter variant is:

```
\startuniqueMPgraphic{name}
  fill OverlayBox withcolor .625yellow ;
  draw OverlayBox withcolor .625red ;
\stopuniqueMPgraphic
```

You may wonder why unique graphics are needed when a single graphic might be used multiple times by scaling it to fit the situation. Since a unique graphic is calculated for each distinctive case, we can be sure that the current circumstances are taken into account. Also, scaling would result in incomparable graphics. Consider the following definition:

```
\startuseMPgraphic{demo}
  draw unitsquare
    xscaled 5cm yscaled 1cm
    withpen pencircle scaled 2mm
    withcolor .625red ;
\stopuseMPgraphic
```

Since we reuse the graphic, the dimensions are sort of fixed, and because the graphic is calculated once, scaling it will result in incompatible line widths.



These graphics were placed with:

```
\hbox \bgroup
  \scale[width=5cm,height=1cm]{\useMPgraphic{demo}}\quad
  \scale[width=8cm,height=1cm]{\useMPgraphic{demo}}%
\egroup
```

Imagine what happens when we add some buttons to an interactive document without taking care of this side effect. All the frames would look different. Consider the following example.

```
\startuniqueMPgraphic{right or wrong}
  pickup pencircle scaled .075 ;
  fill unitsquare withcolor .8white ;
  draw unitsquare withcolor .625red ;
  currentpicture := currentpicture
    xscaled OverlayWidth yscaled OverlayHeight ;
\stopuniqueMPgraphic
```

Let's define this graphic as a background to some buttons.

```
\defineoverlay[button][\uniqueMPgraphic{right or wrong}]
\setupbuttons[background=button,frame=off]
```

```

\hbox
  {\button {previous}           [previouspage]\quad
   \button {next}              [nextpage]\quad
   \button {index}             [index]\quad
   \button {table of contents} [content]}

```

The buttons will look like:



Compare these with:



Here the graphic was defined as:

```

\startuniqueMPgraphic{wrong or right}
  pickup pencircle scaled 3pt ;
  path p ; p := unitsquare
    xscaled OverlayWidth yscaled OverlayHeight ;
  fill p withcolor .8white ;
  draw p withcolor .625red ;
\stopuniqueMPgraphic

```

The last class of embedded graphics are the *runtime* graphics. When a company logo is defined in a separate file `mylogos.mp`, you can run this file by saying:

```

\startMPrun
  input mylogos ;
\stopMPrun

```

The source for the logo is stored in a file named `mylogos.mp`.

```

beginfig(21) ;
  draw fullsquare           withcolor .625red ;
  draw fullsquare rotated 45 withcolor .625red ;
  picture cp ; cp := currentpicture ;
  def copy = addto currentpicture also cp enddef ;
  copy scaled .9 withcolor .625white ;
  copy scaled .7 withcolor .625yellow ;
  copy scaled .6 withcolor .625white ;
  copy scaled .4 withcolor .625red ;
  copy scaled .3 withcolor .625white ;
  fill fullcircle scaled .2 withcolor .625yellow ;
  currentpicture := currentpicture scaled 50 ;
endfig ;
end .

```

In this example the result is available in the virtual file `mprun.21`. This file can be included in the normal way, using:

```

\externalfigure[mprun.21][width=5cm]

```

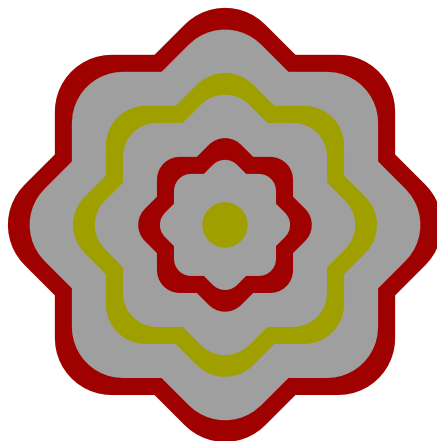

Figure 3.1 The logo is defined in the file `mylogos.mp` as figure 21 and processed by means of the `mprun` method.

Optionally you can specify a name and an instance. This has the advantage that the graphics don't interfere with the regular inline graphics. Here the instance used is `extrafun` and the name where the run is stored is `mydemo`.

```
\startMPrun{extrafun::mydemo}
  input mfun-mrun-demo.mp ;
\stopMPrun

\placefigure
{An external file can have multiple graphics. Here we show a few
 images that we used to use on the \PRAGMA\ \CONTEXT\ website.}
{\startcombination[2*2]
  {\externalfigure[mprun:extrafun::mydemo.1] [height=6cm]} {downloads}
  {\externalfigure[mprun:extrafun::mydemo.2] [height=6cm]} {links}
  {\externalfigure[mprun:extrafun::mydemo.3] [height=6cm]} {mirrors}
  {\externalfigure[mprun:extrafun::mydemo.4] [height=6cm]} {team}
\stopcombination}
```

Keep in mind that the whole file will be processed (using the built in library) in order to get one graphic. Normally this is no big deal.

3.4 Using METAFUN but not CONTEXT

If you don't want to use `CONTEXT` but still want to use `METAFUN`, a rather convenient method is the following. Create a file that

```
\startMPpage
  % Your mp code goes here. You can use the texttext
  % macro as discussed later to deal with typeset text.
\stopMPpage
```

When you process that file with the `context` command you will get a PDF file that you can include in any application that can embed a PDF image. In this case your exposure to `CONTEXT` is minimal.

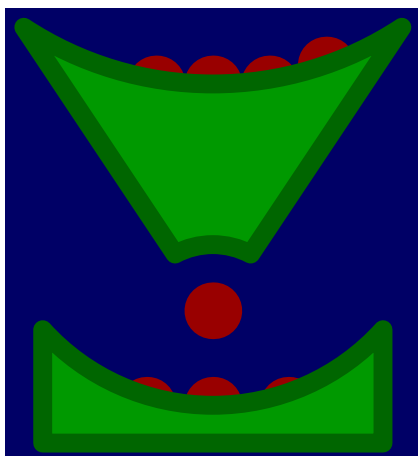

downloads



links

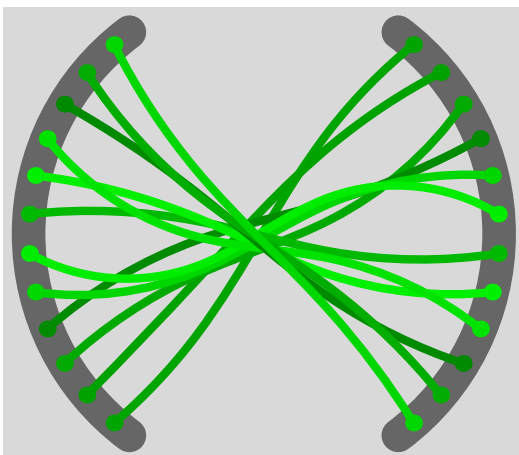

mirrors



team

Figure 3.2 An external file can have multiple graphics. Here we show a few images that we used to use on the PRAGMA ADE CON_TE_XT website.

3.5 Graphic buffers

In addition to the macros defined in the previous section, you can use CON_TE_XT's buffers to handle graphics. This can be handy when making documentation, so it makes sense to spend a few words on them.

A buffer is a container for content that is to be (re)used later on. The main reason for their existence is that they were needed for typesetting manuals and articles on T_EX. By putting the code snippets in buffers, we don't have to key in the code twice, since we can either show the code of buffers verbatim, or process the code as part of the text flow. This means that the risk of mismatch between the code shown and the typeset text is minimized.

```
\startbuffer
You are reading the \METAFUN\ manual.
\stopbuffer
```

This buffer can be typeset verbatim using `\typebuffer` and processed using `\getbuffer`, as we will do now:

An other advantage of using buffers, is that they help you keeping the document source clean. In many places in this manual we put table or figure definitions in a buffer and pass the buffer to another command, like:

```
\placefigure{A very big table}{\getbuffer}
```

Sometimes it makes sense to collect buffers in separate files. In that case we give them names.

This time we should say `\typebuffer[mfun]` to typeset the code verbatim. Instead of \TeX code, we can put `METAPOST` definitions in buffers.

Buffers can be used to stepwise build graphics. By putting code in multiple buffers, you can selectively process this code.

```
\startbuffer[red]
drawoptions(withcolor .625red) ;
\stopbuffer

\startbuffer[yellow]
drawoptions(withcolor .625yellow) ;
\stopbuffer
```

We can now include the same graphic in two colors by simply using different buffers. This time we use the special command `\processMPbuffer`, since `\getbuffer` will typeset the code fragment, which is not what we want.

```
\startlinecorrection[blank]
\processMPbuffer[red,graphic]
\stoplinecorrection
```

The line correction macros take care of proper spacing around the graphic. The `[blank]` directive tells `CONTEXT` to add more space before and after the graphic.

```
\startlinecorrection[blank]
\processMPbuffer[yellow,graphic]
\stoplinecorrection
```

Which mechanism you use, (multiple) buffers or (re)usable graphics, depends on your preferences. Buffers are slower but don't take memory, while (re)usable graphics are stored in memory which means that they are accessed faster.

3.6 Communicating color

Now that color has moved to the desktop, even simple documents have become more colorful, so we need a way to consistently apply color to text as well as graphics. In `CONTEXT`, colors are called by name.

The next definitions demonstrate that we can define a color using different color models, RGB or CMYK. Depending on the configuration, `CONTEXT` will convert one color system to the other, RGB to CMYK, or vice versa. The full repertoire of color components that can be set is as follows.

```

\definecolor[color one] [r=.1, g=.2, b=.3]
\definecolor[color two] [c=.4, m=.5, y=.6, k=.7]
\definecolor[color three] [s=.8]

```

The numbers are limited to the range 0...1 and represent percentages. Black is represented by:

```

\definecolor[black 1] [r=0, g=0, b=0]
\definecolor[black 2] [c=0, m=0, y=0, k=1]
\definecolor[black 3] [s=0]

```

Predefined colors are passed to METAPOST graphics via the `\MPcolor`. First we define some colors.

```

\definecolor[darkyellow] [y=.625] % a CMYK color
\definecolor[darkred] [r=.625] % a RGB color
\definecolor[darkgray] [s=.625] % a gray scale

```

These are the colors we used in this document. The next example uses two of them.

```

\startuseMPgraphic{color demo}
  pickup pencircle scaled 1mm ;
  path p ; p := fullcircle xscaled 10cm yscaled 1cm ;
  fill p withcolor \MPcolor{darkgray} ;
  draw p withcolor \MPcolor{darkred} ;
\stopuseMPgraphic
\useMPgraphic{color demo}

```

The previous example uses a pure RGB red shade, combined with a gray fill.



Originally METAPOST only supported only the RGB and gray color spaces. In METAFUN we also supported CMYK and spot colors, using an extension mechanism that hooked into the backend. At some point METAPOST got native support for CMYK. When you use mixed color models you need to be aware of the fact that their related variables have different types:

```

gray  numeric   s
rgb   color     (r,g,b)
cmyk  cmykcolor (c,m,y,k)

```

Because in METAFUN (`mpiv`) we hook deeply into the `CONTEXT` color mechanisms we can use symbolic names instead. and these are just strings.

There is a fundamental difference between a yellow as defined in `CONTEXT` using CMYK and a RGB yellow.

```

\definecolor[cmyyellow] [y=1]
\definecolor[rgbyellow] [r=1,g=1]

\definecolor[cmydarkyellow] [y=.625]
\definecolor[rgbdarkyellow] [r=.625,g=.625]

```

Figure 3.3 demonstrates what happens when we multiply colors by a factor. Since we are not dealing with real CMYK colors, multiplication gives different results for CMYK colors passed as `\MPcolor`. Figure 3.4 we show the same colors but this time we use a different method, one that avoids the `TEX` macro. This method can be used in MKIV. We will use both methods in examples.

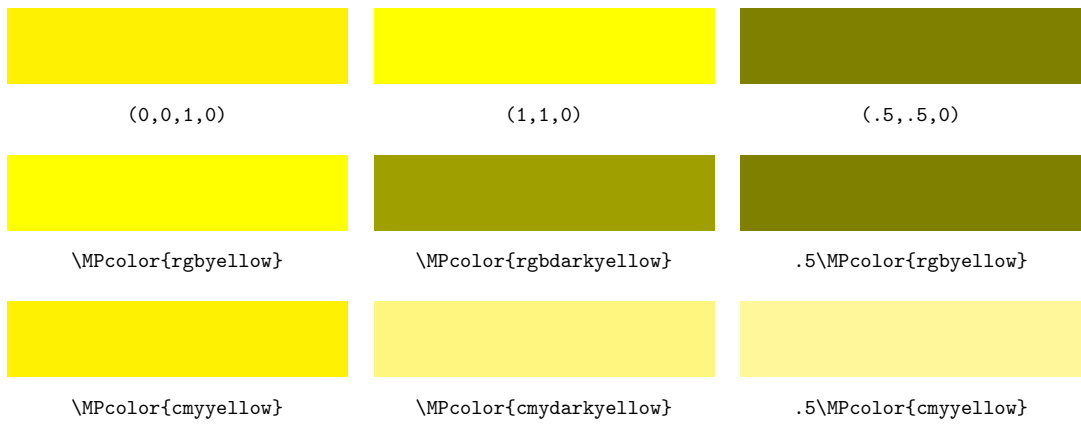

Figure 3.3 All kinds of yellow (passing valued from T_{EX}).

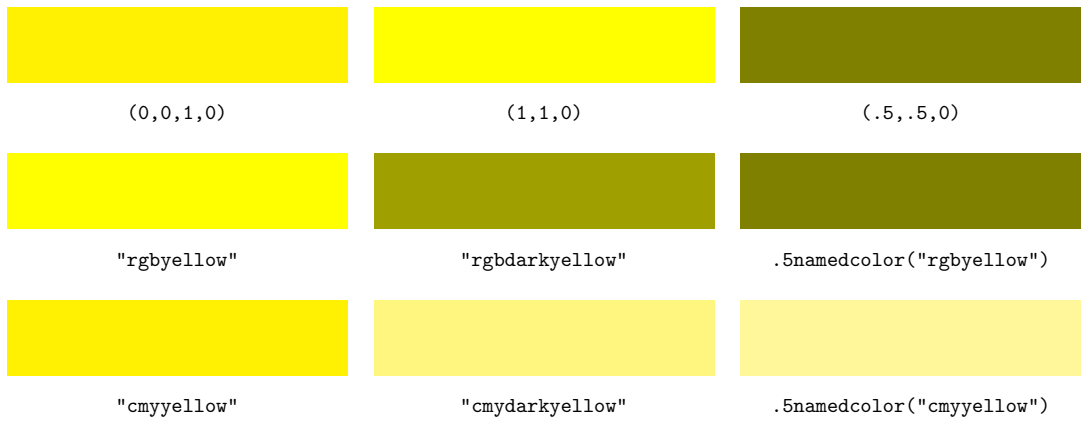

Figure 3.4 All kinds of yellow (fetching values from T_{EX}).

So, `.625red` is the same as `[r=.5]`, but `.625yellow` is not the same as `[y=.5]`, but matches `[r=.5,g=.5]`. Figure 3.5 shows the pure and half reds.

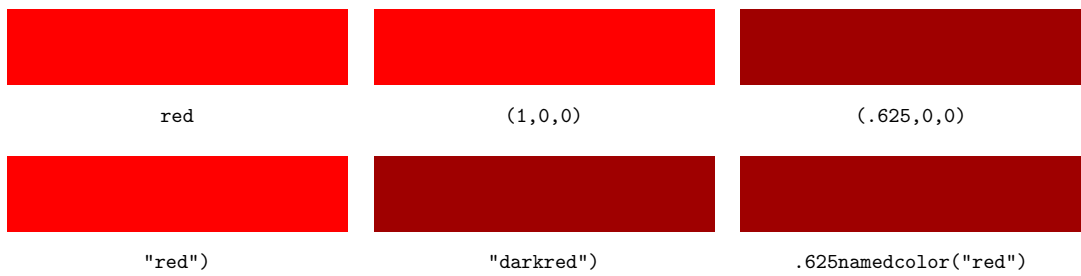

Figure 3.5 Some kinds of red.

In order to prevent problems, we advise you to stick to RGB color when you create documents for screen and CMYK when producing for print.

In the METAFUN macro collection there is a macro `cmym` that takes four arguments, representing the cyan, magenta, yellow, and black component. Nowadays you don't need it as we have native CMYK.

```
fill unitsquare xyscaled (10cm, 5mm) withcolor cmyk(1,0,.3,.3) ;
fill unitsquare xyscaled (10cm,-5mm) withcolor (1,.3,0,.3) ;
```



If you take a close look at the numbers, you will notice that the cyan component results in a 100% ink contribution. You will also notice that 30% black ink is added. This means that we cannot safely convert this color to RGB ($r = 1 - c - k < 0$) without losing information. Nevertheless the previous blue bar is presented all right. This is due to the fact that in METAFUN the CMYK colors are handled as they should, even when METAPOST does not support this color model.

If you use this feature independent of CONTEXT, you need to enable it by setting `cmkcolors` to true. You have to convert the resulting graphic to PDF by using for instance the `mptopdf` suite.

In CONTEXT you can influence this conversion by changing parameters related to color handling:

```
\setupcolors[cmk=yes,rgb=no]
```

Unless you know what you are doing, you don't have to change the default settings (both yes). In the CONTEXT reference manual you can also read how color reduction can be handled.

Special care should be paid to gray scales. Combining equal quantities of the three color inks will not lead to a gray scale, but to a muddy brown shade.

```
fill fullsquare xyscaled (10cm, 2cm) withcolor .5white ;
fill fullsquare xyscaled ( 6cm,1.5cm) withcolor cmyk(.5,.5,.5,0) ;
fill fullsquare xyscaled ( 2cm, 1cm) withcolor cmyk(0,0,0,.5) ;
```



In figure 3.6 and 3.7 you can see some more colors defined in the CMYK color space. When you display the screen version of this document, you will notice that the way colors are displayed can differ per viewer. This is typical for CMYK colors and has to do with the fact that some assumptions are made with respect to the (print) medium.



Figure 3.6 CMYK support enabled.

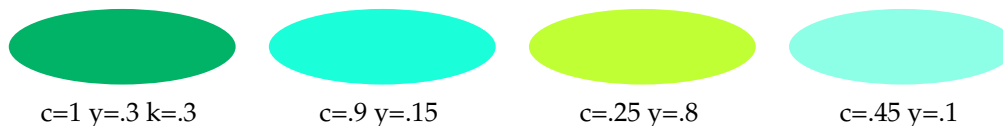

Figure 3.7 CMYK support disabled, no support in METAPOST.

3.7 One page graphics

An advantage of using CONTEXT to make your METAPOST graphics is you don't have to bother about specials, font inclusion and all those nasty things that can spoil a good day. An example of such a graphic is the file `mfun-800` that resides on the computer of the author.

```

% language-uk
%
% copyright=pragma-ade readme=readme.pdf licence=cc-by-nc-sa

\setupMPpage
  [offset=1pt,
   background=color,
   backgroundcolor=gray]

\definecolor [gray] [s=.625]
\definecolor [red] [r=.625]
\definecolor [yellow] [r=.625,g=.625]

\startuseMPgraphic{test}
  fill fullsquare rotated 45 scaled 4cm
  withcolor \MPcolor{yellow} ;
\stopuseMPgraphic

\starttext

\startMPpage
  \includeMPgraphic{test}
  fill fullcircle scaled 3cm
  withcolor \MPcolor{red} ;
\stopMPpage

\stoptext

```

Given that `CONTEXT` is present on your system, you can process this file with:

```
context mfun-800
```

You can define many graphics in one file. Later you can include individual pages from the resulting PDF file in your document:

```

\placefigure
  {A silly figure, demonstrating that stand||alone||graphics
   can be made.}
  {\typesetfile[mfun-800.tex][page=1]}

```

In this case the `page=1` specification is not really needed. You can scale and manipulate the figure in any way supported by the macro package that you use.

3.8 Managing resources

A graphic consists of curves, either or not filled with a given color. A graphic can also include text, which means that fonts are used. Finally a graphic can have special effects, like a shaded fill. Colors, fonts and special effects go under the name resources, since they may demand special care or support from the viewing or printing device.

Special effects, like shading, are supported by dedicated `METAPOST` modules. These are included in the `CONTEXT` distribution and will be discussed later in chapter 8.

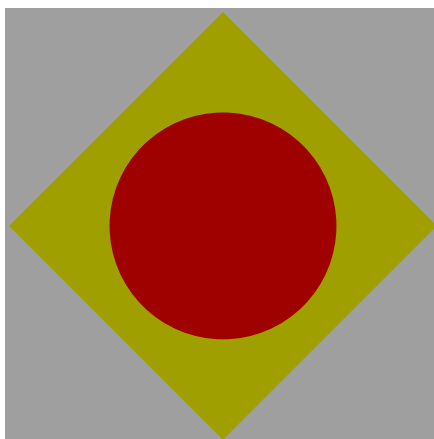

Figure 3.8 A silly figure, demonstrating that stand-alone-graphics can be made.

Since METAPOST supports color, an embedded graphic can be rather colorful. However, when color support is disabled or set up to convert colors to gray scales, CONTEXT will convert the colors in the graphics to gray scales.

You may wonder what the advantage is of weighted gray conversion. Figure 3.9 shows the difference between natural colors, weighted gray scales and straightforward, non-weighted, gray scales.

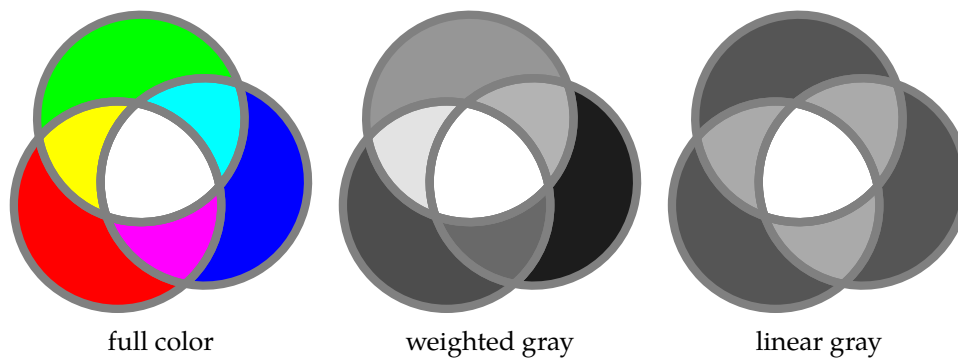

Figure 3.9 The advantage of weighted gray over linear gray.

When we convert color to gray, we use the following formula. This kind of conversion also takes place in black and white televisions.

$$G = .30r + .59g + .11b$$

Section 8.6 introduces the `grayed` operation that you can use to convert a colored picture into a gray one. This macro uses the same conversion method as mentioned here.

3.9 Instances

There are a few instances predefined and if you want to isolate your own graphics from whatever CONTEXT itself cooks up, you can define more as the extra overhead can be neglected.

name	format	extensions	initializations	method
metafun	metafun	yes	yes	

extrafun	metafun	yes	yes	
lessfun	metafun			
doublefun	metafun	yes	yes	double
binaryfun	metafun	yes	yes	binary
decimalfun	metafun	yes	yes	decimal

According to this the doublefun instance is defined as:

```
\defineMPinstance
  [doublefun]
  [format=metafun,
   extensions=yes,
   initializations=yes,
   method=double]
```

The extensions key relates to:

```
\startMPextensions
  % some code
\stopMPextensions
```

that are used to pass (common) extensions to the instance. The initializations key relates to:

```
\startMPinitializations
  % some code
\stopMPinitializations
```

that are used to communicate TeX properties to the instance (they are expanded each graphic). Instance bound definitions can be set with:

```
\startMPdefinitions{doublefun}
  % some code
\stopMPdefinitions
```

We do have more instances, for instance for the chemical subsystem. If you load the graph module you get a double precision graph instance. We might use more private ones in the future.

When you make graphic pages, you can do this:

```
\startMPpage[instance=doublefun]
  % some code
\stopMPpage
```

When you use the other commands you can optionally specify an instance:

```
\startMPcode{metafun}
  draw texttext(decimal pi) scaled 2 withcolor .625red ;
  draw boundingbox currentpicture enlarged 2pt ;
\stopMPcode

\startMPcode{extrafun}
  draw texttext(decimal pi) scaled 2 withcolor .625green ;
  draw boundingbox currentpicture enlarged 2pt ;
\stopMPcode
```

```

\startMPcode{doublefun}
  draw texttext(decimal pi) scaled 2 withcolor .625blue ;
  draw boundingbox currentpicture enlarged 2pt ;
\stopMPcode

\startMPcode{binaryfun}
  draw texttext(decimal pi) scaled 2 withcolor .625yellow ;
  draw boundingbox currentpicture enlarged 2pt ;
\stopMPcode

\startMPcode{decimalfun}
  draw texttext(decimal pi) scaled 2 withcolor .375white ;
  draw boundingbox currentpicture enlarged 2pt ;
\stopMPcode

```

The result is shown in figure 3.10 and as expected there is a different value for π reported.

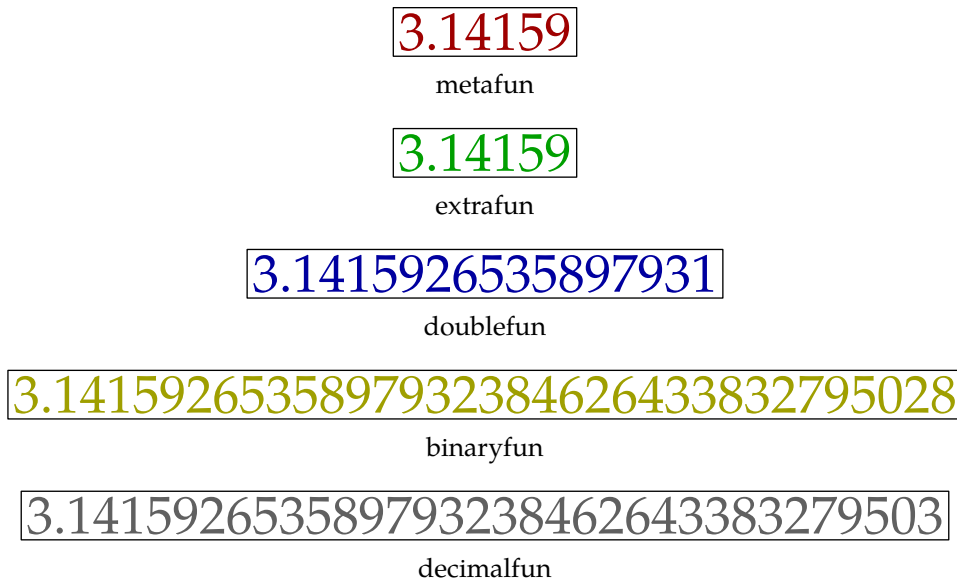

Figure 3.10 Instances can use different number systems.

You need to be aware of the fact that the results of a (for instance) double instance can differ from a scaled (the default) one. As long as graphics can be processed in both models (which is the case as long as the dimensions stay below 4096 base points) the outcome is probably not that different. However, we've seen that the accuracy of for instance π (just a variable) differs. I like to use random values and the random generators are definitely different: each of the number libraries has its own implementation. Let's look at that. We define two random graphic generators:

```

\startuseMPgraphic{normaldeviate}
  randomseed := 100 ;
  draw fullsquare
    withpen pencircle scaled 1/200
    withcolor .5white ;
  for i=1 upto 500 :
    draw (normaldeviate,normaldeviate)
      scaled 1/3

```

```

        withpen pencircle scaled 1/30
        withtransparency (1,.5) ;
    endfor ;
    setbounds currentpicture to
        boundingbox fullcircle
        enlarged 1/2 ;
    currentpicture :=
        currentpicture
        xsized (2TextWidth/5) ;
\stopuseMPgraphic

```

And:

```

\startuseMPgraphic{uniformdeviate}
    randomseed := 100 ;
    draw fullsquare
        withpen pencircle scaled 1/200
        withcolor .5white ;
    for i=1 upto 500 :
        draw (-1/2 + uniformdeviate 1,-1/2 + uniformdeviate 1)
            withpen pencircle scaled 1/30
            withtransparency (1,.5) ;
    endfor ;
    setbounds currentpicture to
        boundingbox fullcircle
        enlarged 1/2 ;
    currentpicture :=
        currentpicture
        xsized (2TextWidth/5) ;
\stopuseMPgraphic

```

We show the results for a normaldeviate in figure 3.11 upto 3.14 you see the randomizers per number system. In figure 3.15 we demonstrate that the scaled version has its own variant.

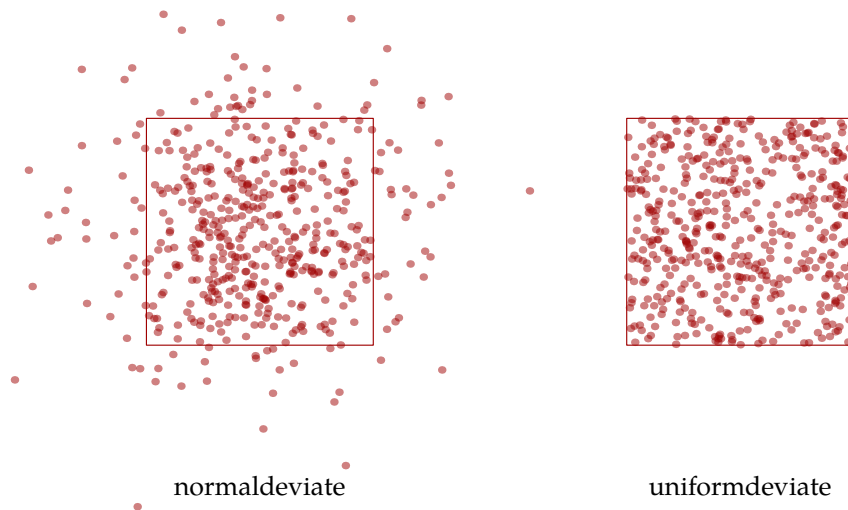

Figure 3.11 The scaled randomizers.

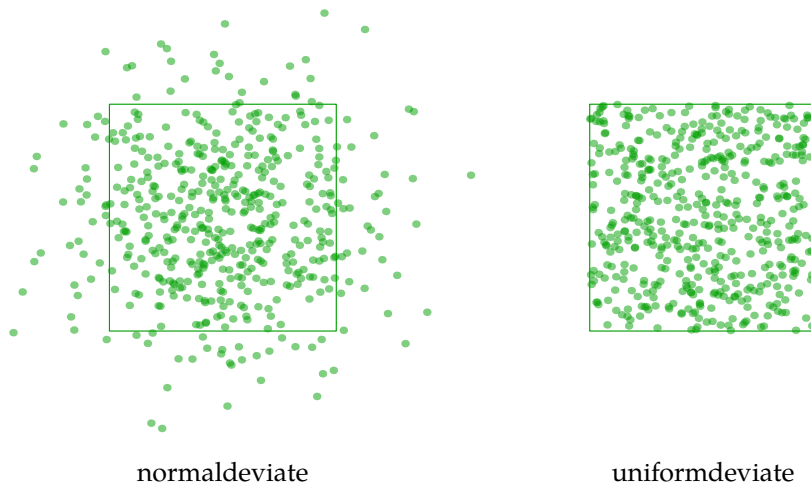

Figure 3.12 The double randomizers.

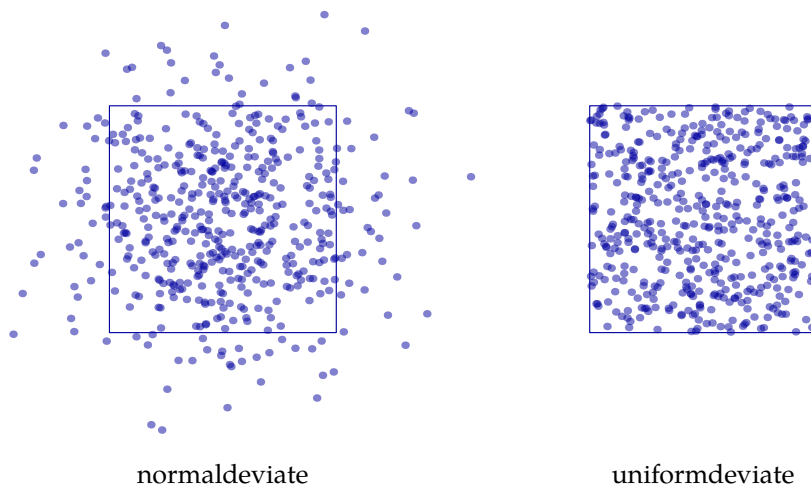

Figure 3.13 The decimal randomizers.

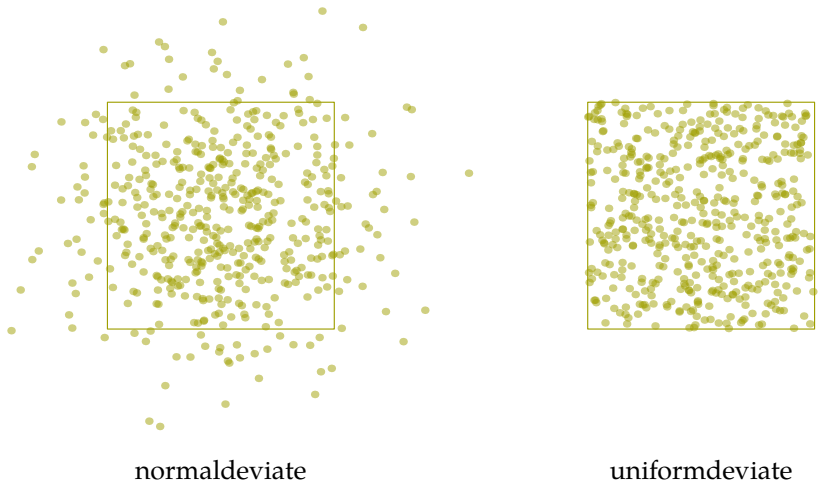

Figure 3.14 The binary randomizers.

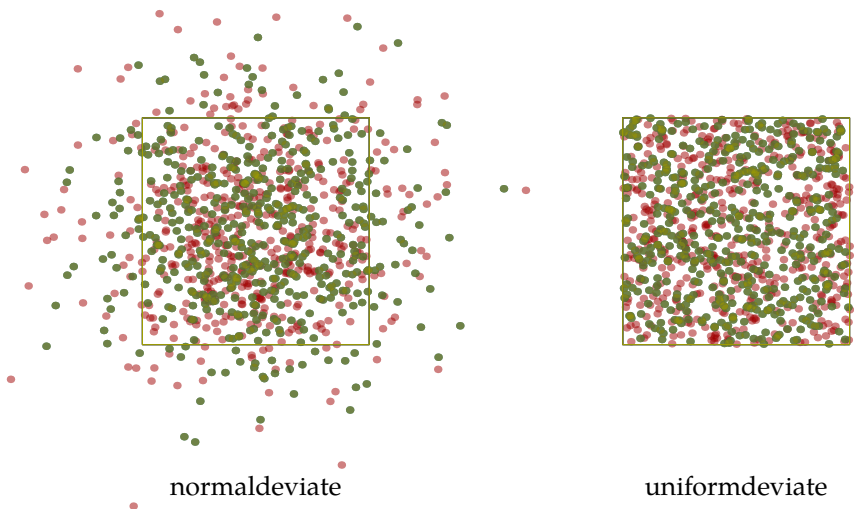

Figure 3.15 Normaldeviate and uniformdeviate overlaid.

4 Enhancing the layout

One of the most powerful and flexible commands of `CONTEXT` is `\framed`. We can use the background features of this command to invoke and position graphics that adapt themselves to the current situation. Once understood, overlays will become a natural part of the `CONTEXT` users toolkit.

4.1 Overlays

Many `CONTEXT` commands support overlays. The term *overlay* is a bit confusing, since such an overlay in most cases will lay under the text. However, because there can be many layers on top of each other, the term suits its purpose.

When we want to put a `METAPOST` graphic under some text, we go through a three step process. First we define the graphic itself:

```
\startuniqueMPgraphic{demo circle}
  path p ;
  p := fullcircle xscaled \overlaywidth yscaled \overlayheight ;
  fill p withcolor .85white ;
  draw p withpen pencircle scaled 2pt withcolor .625red ;
\stopuniqueMPgraphic
```

This graphic will adapt itself to the width and height of the overlay. Both `\overlaywidth` and `\overlayheight` are macros that return a dimension followed by a space. The next step is to register this graphic as an overlay.

```
\defineoverlay[demo circle][\uniqueMPgraphic{demo circle}]
```

We can now use this overlay in any command that provides the `\framed` functionality. Since this graphic is defined as unique, `CONTEXT` will try to reuse already calculated and embedded graphics when possible.

```
\framed[background=demo circle]{This text is overlaid.}
```

The background can be set to `color`, `screen`, an overlay identifier, like `demo circle`, or a comma separated list of those.

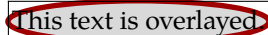

The `\framed` command automatically draws a ruled box, which can be quite useful when debugging a graphic. However, in this case we want to turn the frame off.

```
\framed
  [background=demo circle,frame=off]
  {This text is overlaid.}
```



In this case, it would have made sense to either set the `offset` to a larger value, or to set `backgroundoffset`. In the latter case, the ellipse is positioned outside the frame.

The difference between the three offsets `offset`, `frameoffset` and `backgroundoffset` is demonstrated in figure 4.1. While the `offset` is added to the (natural or specified) dimensions of the content of the box, the other two are applied to the frame and background and don't add to the dimensions.

In the first row we only set the `offset`, while in the second row, the (text) `offset` is set to 3pt. When not specified, the `offset` has a comfortable default value of `.25ex` (some 25% of the height of an `x`).

```
\setupframed
  [width=.3\textwidth,
   background=demo circle]
\startcombination[3*3]
  {\framed[offset=none]           {\TeX}} {\tt offset=none}
  {\framed[offset=overlay]       {\TeX}} {\tt offset=overlay}
  {\framed[offset=0pt]           {\TeX}} {\tt offset=0pt}
  {\framed[offset=1pt]           {\TeX}} {\tt offset=1pt}
  {\framed[offset=2pt]           {\TeX}} {\tt offset=2pt}
  {\framed[offset=4pt]           {\TeX}} {\tt offset=4pt}
  {\framed[offset=3pt]           {\TeX}} {\tt offset=3pt}
  {\framed[frameoffset=3pt]      {\TeX}} {\tt frameoffset=3pt}
  {\framed[backgroundoffset=3pt]{\TeX}} {\tt backgroundoffset=3pt}
\stopcombination
```

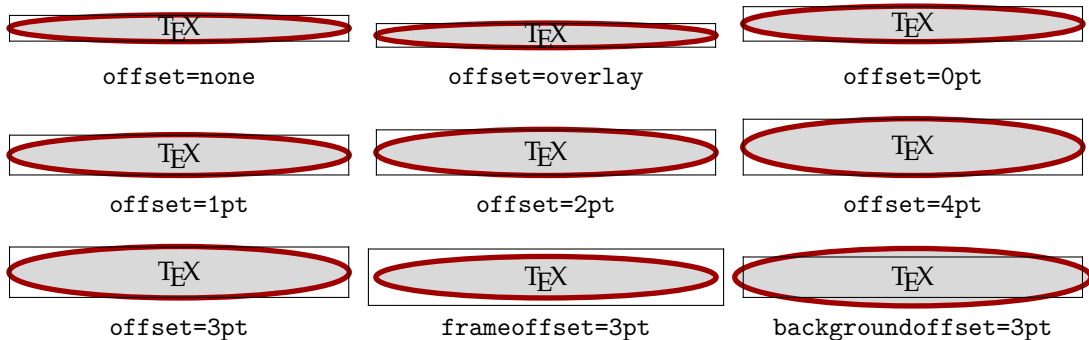

Figure 4.1 The three offsets.

As the first row in figure 4.1 demonstrates, instead of a value, one can pass a keyword. The `overlay` keyword implies that there is no offset at all and that the lines cover the content. With `none` the frame is drawn tight around the content. When the `offset` is set to 0pt or more, the text is automatically set to at least the height of a line. You can turn this feature off by saying `strut=off`. More details can be found in the `CONTEXT` manual.

In figure 4.2 we have set `offset` to 3pt, `frameoffset` to 6pt and `backgroundoffset` to 9pt. Both the frame and background offset are sort of imaginary, since they don't contribute to the size of the box.

```
\ruledhbox
  {\framed
    [offset=3pt,frameoffset=6pt,backgroundoffset=9pt,
     background=screen,backgroundscreen=.85]
    {Welcome in the hall of frame!}}
```

Welcome in the hall of frame!

Figure 4.2 The three offsets.

4.2 Overlay variables

The communication between \TeX and embedded METAPOST graphics takes place by means of some macros.

overlay status macro	meaning
<code>\overlaywidth</code>	the width of the graphic, as calculated from the actual width and background offset
<code>\overlayheight</code>	the height of the graphic, as calculated from the actual height, depth and background offset
<code>\overlaydepth</code>	the depth of the graphic, if available
<code>\overlaycolor</code>	the background color, if given
<code>\overlaylinecolor</code>	the color of the frame
<code>\overlaylinewidth</code>	the width of the frame

The dimensions of the overlay are determined by dimensions of the background, which normally is the natural size of a `\framed`. When a background offset is specified, it is added to `overlayheight` and `overlaywidth`.

Colors can be converted by `\MPcolor` and in addition to the macros mentioned, you can use all macros that expand into a dimension or dimen register prefixed by the \TeX primitive `\the` (this and other primitives are explained in “The \TeX book”, by Donald Knuth).

4.3 Stacking overlays

A background can be a gray scale (`screen`), a color (`color`), a previously defined overlay identifier, or any combination of these. The next assignments are therefore valid:

```
\framed[background=color,backgroundcolor=red]{...}
\framed[background=screen,backgroundscreen=.8]{...}
\framed[background=circle]{...}
\framed[background={color,cow},backgroundcolor=red]{...}
\framed[background={color,cow,grid},backgroundcolor=red]{...}
```

In the last three cases of course you have to define `circle`, `cow` and `grid` as overlay. These items are packed in a comma separated list, which has to be surrounded by `{}`.

4.4 Foregrounds

The overlay system is actually a system of layers. Sometimes we are confronted with a situation in which we want the text behind another layer. This can be achieved by explicitly placing the foreground layer, as in figure 4.3.

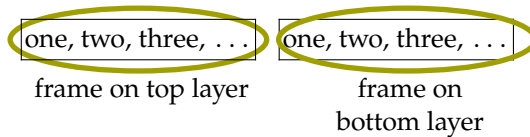

Figure 4.3 Foreground material moved backwards.

The graphic layer is defined as follows:

```
\startuniqueMPgraphic{backfore}
  draw fullcircle
    xscaled \overlaywidth yscaled \overlayheight
    withpen pencircle scaled 2pt
    withcolor .625yellow ;
\stopuniqueMPgraphic

\defineoverlay[backfore][\uniqueMPgraphic{backfore}]
```

The two framed texts have a slightly different definition. The leftmost graphic is defined as:

```
\framed
  [background=backfore,backgroundoffset=4pt]
  {one, two, three, \unknown}
```

The rightmost graphic is specified as:

```
\framed
  [background={foreground,backfore},backgroundoffset=4pt]
  {one, two, three, \unknown}
```

The current values of the frame color and frame width are passed to the overlay. It often makes more sense to use colors defined at the document level, if only to force consistency.

```
\startuniqueMPgraphic{super ellipse}
  path p ; p := unitsquare
    xscaled \overlaywidth yscaled \overlayheight
    superellipsed .85 ;
  pickup pencircle scaled \overlaylinewidth ;
  fill p withcolor \MPcolor{\overlaycolor} ;
  draw p withcolor \MPcolor{\overlaylinecolor} ;
\stopuniqueMPgraphic

\defineoverlay[super ellipse][\uniqueMPgraphic{super ellipse}]
```

This background demonstrates that a super ellipse is rather well suited as frame.

```
\framed
  [background=super ellipse,
  frame=off,
  width=3cm,
  align=middle,
  framecolor=darkyellow,
  rulethickness=2pt,
```

```
backgroundcolor=darkgray]
{\white This is a\Super Ellipsed\sentence.}
```

Such a super ellipse looks quite nice and is a good candidate for backgrounds, for which the superness should be at least .85.

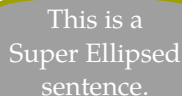

This is a
Super Ellipsed
sentence.

4.5 Typesetting graphics

I have run into people who consider it kind of strange when you want to use T_EX for non-mathematical typesetting. If you agree with them, you may skip this section with your eyes closed.

One of the CON_TE_XT presentation styles (number 15, tagged as balls) stepwise builds screens full of sentences, quotes or concepts, packages in balloons and typesets them as a paragraph. We will demonstrate that T_EX can typeset graphics using the following statement.

“As you may know, T_EX’s ambassador is a lion, while METAFONT is represented by a lioness. It is still unclear if they have a relationship, but if so, and if a cub is born, may it enjoy METAFUN.”

The low level CON_TE_XT macro `\processwords` provides a mechanism to treat the individual words of its argument. The macro is called as follows:

```
\processwords{As you may know, \TEX's ambassador is a lion, while {\METAFONT}
is represented by a lioness. It is still unclear if they have a relationship,
but if so, and if a cub is born, may it enjoy \METAFUN.}
```

In order to perform a task, you should also define a macro `\processword`, which takes one argument. The previous quote was typeset with the following definition in place:

```
\def\processword#1{#1}
```

A slightly more complicated definition is the following:

```
\def\processword#1{\noindent\framed{#1}\space}
```

We now get:

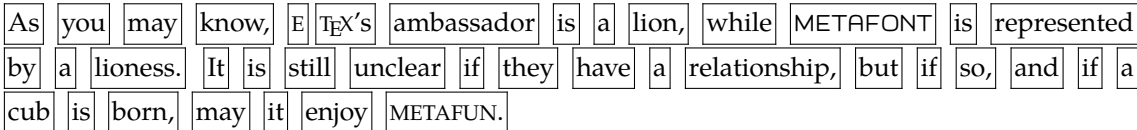

As you may know, E T_EX’s ambassador is a lion, while METAFONT is represented by a lioness. It is still unclear if they have a relationship, but if so, and if a cub is born, may it enjoy METAFUN.

If we can use `\framed`, we can also use backgrounds.

```
\def\processword#1%
{\noindent\framed[frame=off,background=lions]{#1} }
```

We can add a superellipsed frame using the following definition:

```
\startuniqueMPgraphic{lions a}
```

```

path p ; p := fullsquare
  xyscaled (\overlaywidth,\overlayheight) superellipsed .85 ;
pickup pencircle scaled 1pt ;
fill p withcolor .850white ; draw p withcolor .625yellow ;
\stopuniqueMPgraphic

\defineoverlay[lions][\uniqueMPgraphic{lions a}]

```

As you may know, E_TX's ambassador is a lion, while METAFONT is represented by a lioness. It is still unclear if they have a relationship, but if so, and if a cub is born, may it enjoy METAFUN.

```

\startuseMPgraphic{lions b}
  path p ; p := fullsquare
  xyscaled (\overlaywidth,\overlayheight) randomized 5pt ;
pickup pencircle scaled 1pt ;
fill p withcolor .850white ; draw p withcolor .625yellow ;
\stopuseMPgraphic

\defineoverlay[lions][\uniqueMPgraphic{lions b}]

```

As you may know, E_TX's ambassador is a lion, while METAFONT is represented by a lioness. It is still unclear if they have a relationship, but if so, and if a cub is born, may it enjoy METAFUN.

```

\startuniqueMPgraphic{lions c}
  path p ; p := fullsquare
  xyscaled (\overlaywidth,\overlayheight) squeezed 2pt ;
pickup pencircle scaled 1pt ;
fill p withcolor .850white ; draw p withcolor .625yellow ;
\stopuniqueMPgraphic

\defineoverlay[lions][\uniqueMPgraphic{lions c}]

```

As you may know, E_TX's ambassador is a lion, while METAFONT is represented by a lioness. It is still unclear if they have a relationship, but if so, and if a cub is born, may it enjoy METAFUN.

These paragraphs were typeset with the following settings.

```

\setupalign[broad, right] % == \veryraggedright
\setupalign[broad, middle] % == \veryraggedcenter
\setupalign[broad, left] % == \veryraggedleft

```

The broad increases the raggedness. We defined three different graphics (a, b and c) because we want some to be unique, which saves some processing. Of course we don't reuse the random graphics. In the definition of `\processword` we have to use `\noindent` because otherwise `TEX` will put each graphic on a line of its own. Watch the space at the end of the macro.

4.6 Graphics and macros

Because \TeX 's typographic engine and METAPOST's graphic engine are separated, interfacing between them is not as natural as you may expect. In CONTEXT we have tried to integrate them as much as possible, but using the interface is not always as convenient as it should be. What method you follow, depends on the problem at hand.

The official METAPOST way to embed \TeX code into graphics is to use `btex . . . etex`. As soon as CONTEXT writes the graphic data to the intermediate METAPOST file, it looks for these commands. When it has encountered an `etex`, CONTEXT will make sure that the text that is to be typeset by \TeX is *not* expanded. This is what you may expect, because when you would embed those commands in a stand-alone graphic, they would also not be expanded, if only because METAPOST does not know \TeX . With expansion we mean that \TeX commands are replaced by their meaning (which can be quite extensive).

Users of CONTEXT MKIV can skip the next paragraph.

When METAPOST sees a `btex` command, it will consult a so called `mpx` file. This file holds the METAPOST representation of the text typeset by \TeX . Before METAPOST processes a graphic definition file, it first calls another program that filters the `btex` commands from the source file, and generates a \TeX file from them. This file is then processed by \TeX , and after that converted to a `mpx` file. In CONTEXT we let TEXEXEC take care of this whole process.

Because the `btex . . . etex` commands are filtered from the raw METAPOST source code, they cannot be part of macro definitions and loop constructs. When used that way, only one instance would be found, while in practice multiple instances may occur.

This drawback is overcome by METAFUN 's `texttext` command. This command still uses `btex . . . etex` but writes these commands to a separate job related file each time it is used.⁹ After the first METAPOST run, this file is merged with the original file, and METAPOST is called again. So, at the cost of an additional run, we can use text typeset by \TeX in a more versatile way. Because METAPOST runs are much faster than \TeX runs, the price to pay in terms of run time is acceptable. Unlike `btex . . . etex`, the \TeX code in `texttext` command is expanded, but as long as CONTEXT is used this is seldom a problem, because most commands are somewhat protected.

If we define a graphic with text to be typeset by \TeX , there is a good chance that this text is not frozen but passes as argument. A \TeX -like solution for passing arbitrary content to such a graphic is the following:¹⁰

```
\unexpanded\def\RotatedText#1#2%
  {\startuseMPgraphic{RotatedText}
   draw btex #2 etex rotated #1 ;
   \stopuseMPgraphic
   \useMPgraphic{RotatedText}}
```

This macro takes two arguments (the # identifies an argument):

```
\RotatedText{15}{Some Rotated Text}
```

⁹ It took the author a while to find out that there is a METAPOST module called `tex.mp` that provides a similar feature, but with the disadvantage that each text results in a call to \TeX . Each text goes into a temporary file, which is then included and results in METAPOST triggering \TeX .

¹⁰ The `\unexpanded` prefix makes the command robust for being passed as argument. It is not to be confused with the primitive. We had this feature already when the primitive showed up and it was considered to be inconvenient for other macro packages to adapt to the CONTEXT situation. So keep that in mind when you mix macro packages.

The text is rotated over 15 degrees about the origin in a counterclockwise direction.

Some Rotated Text

In `CONTEXT` we seldom pass settings like the angle of rotation in this manner. You can use `\setupMPvariables` to set up graphic-specific variables. Such a variable can be accessed with `\MPvar`.

```
\setupMPvariables[RotatedText][rotation=90]
\startuseMPgraphic{RotatedText}
  draw text{Some Text} rotated \MPvar{rotation} ;
\stopuseMPgraphic
```

An example:

```
\RotatedText{-15}{Some Rotated Text}
```

Some Rotated Text

In a similar fashion we can isolate the text. This permits us to use the same graphics with different settings.

```
\setupMPvariables[RotatedText][rotation=270]
\setMPtext{RotatedText}{Some Text}
\startuseMPgraphic{RotatedText}
  draw \MPbetex{RotatedText} rotated \MPvar{rotation} ;
\stopuseMPgraphic
```

This works as expected:

```
\RotatedText{165}{Some Rotated Text}
```

Some Rotated Text

It is now a small step towards an encapsulating macro (we assume that you are familiar with `TEX` macro definitions).

```
\def\RotatedText[#1]#2%
  {\setupMPvariables[RotatedText][#1]%
  \setMPtext{RotatedText}{#2}%
  \useMPgraphic{RotatedText}}

\setupMPvariables[RotatedText][rotation=90]
\startuseMPgraphic{RotatedText}
  draw \MPbetex{RotatedText} rotated \MPvar{rotation} ;
\stopuseMPgraphic
```

Again, we default to a 90 degrees rotation, and pass both the settings and text in an indirect way. This method permits you to build complicated graphics and still keep macros readable.

```
\RotatedText[rotation=240]{Some Rotated Text}
```

Some Rotated Text

You may wonder why we don't use the variable mechanism to pass the text. The main reason is that the text mechanism offers a few more features, one of which is that it passes the text straight on, without the danger of unwanted expansion of embedded macros. Using `\setMPtext` also permits you to separate \TeX and \METAPOST code and reuse it multiple times (imagine using the same graphic in a section head command).

There are three ways to access a text defined with `\setMPtext`. Imagine that we have the following definitions:

```
\setMPtext {1} {Now is this \TeX\ or not?}
\setMPtext {2} {See what happens here.}
\setMPtext {3} {Text streams become pictures.}
```

The `\MPbetex` macro returns a `btex ... etex` construct. The `\MPstring` returns the text as a \METAPOST string, between quotes. The raw text can be fetched with `\MPtext`.

```
\startMPcode
  picture p ; p := \MPbetex {1} ;
  picture q ; q := texttext( \MPstring{2} ) ;
  picture r ; r := thelabel("\MPtext {3}",origin) ;

  for i=p, boundingbox p : draw i withcolor .625red ; endfor ;
  for i=q, boundingbox q : draw i withcolor .625yellow ; endfor ;
  for i=r, boundingbox r : draw i withcolor .625white ; endfor ;

  currentpicture := currentpicture scaled 2 ;
  draw origin
    withpen pencircle scaled 5.0mm withcolor white ;
  draw origin
    withpen pencircle scaled 2.5mm withcolor black ;
  draw boundingbox currentpicture
    withpen pencircle scaled .1mm
    dashed evenly ;
\stopMPcode
```

The first two lines return text typeset by \TeX , while the last line leaves this to \METAPOST .

If you watch closely, you will notice that the first (red) alternative is positioned with the baseline on the origin.

```
\startMPcode
  picture p ; p := \MPbetex {1} ;
```

```

picture q ; q := texttext.origin( \MPstring{2}      ) ;
picture r ; r := thelabel.origin("\MPtext  {3}",origin) ;

for i=p, boundingbox p : draw i withcolor .625red      ; endfor ;
for i=q, boundingbox q : draw i withcolor .625yellow ; endfor ;
for i=r, boundingbox r : draw i withcolor .625white  ; endfor ;

currentpicture := currentpicture scaled 2 ;
draw origin withpen pencircle scaled 5.0mm
  withcolor white ;
draw origin withpen pencircle scaled 2.5mm
  withcolor black ;
draw boundingbox currentpicture
  withpen pencircle scaled .1mm
  dashed evenly ;
\stopMPcode

```

This draws:



This picture demonstrates that we can also position `texttext`'s and `label`'s on the baseline. For this purpose the repertoire of positioning directives (`top`, `lft`, etc.) is extended with an `origin` directive. Another extra positioning directive is `raw`. This one does not do any positioning at all.

```

picture q ; q := texttext.origin( \MPstring{2}      ) ;
picture r ; r := thelabel.origin("\MPtext  {3}",origin) ;

```

We will now apply this knowledge of text inclusion in graphics to a more advanced example. The next definitions are the answer to a question on the `CONTEXT` mailinglist with regards to framed texts with titles.

Zapf (1)

Coming back to the use of typefaces in electronic publishing: many of the new typographers receive their knowledge and information about the rules of typography from books, from computer magazines or the instruction manuals which they get with the purchase of a PC or software.

In this example, the title is positioned on top of the frame. Title and text are entered as:

```

\FrameTitle{Zapf (1)}

\StartFrame
Coming back to the use of typefaces in electronic
publishing: many of the new typographers receive their
knowledge and information about the rules of typography from
books, from computer magazines or the instruction manuals
which they get with the purchase of a PC or software.
\StopFrame

```

The implementation is not that complicated and uses the frame commands that are built in CON-
TEXT. Instead of letting T_EX draw the frame, we use METAPOST, which we also use for handling the
title. The graphic is defined as follows:

```
\startuseMPgraphic{FunnyFrame}
  picture p ; numeric w, h, o ;
  p := texttext.rt(\MPstring{FunnyFrame}) ;
  w := OverlayWidth ; h := OverlayHeight ; o := BodyFontSize ;
  p := p shifted (2o,h-ypart center p) ; draw p ;
  drawoptions (withpen pencircle scaled 1pt withcolor .625red) ;
  draw (2o,h)--(0,h)--(0,0)--(w,0)--(w,h)--(xpart urcorner p,h) ;
  draw boundingbox p ;
  setbounds currentpicture to unitsquare xyscaled(w,h) ;
\stopuseMPgraphic
```

Because the framed title is partly positioned outside the main frame, and because the main frame
will be combined with the text, we need to set the boundingbox explicitly. This is a way to create
so called free figures, where part of the figure lays beyond the area that is taken into account when
positioning the graphic. The shift

```
... shifted (2o,h-ypart center p)
```

ensures that the title is vertically centered over the top line of the main box.

The macros that use this graphic combine some techniques of defining macros, using predefined
CONTEXT classes, and passing information to graphics.

```
\defineoverlay[FunnyFrame] [\useMPgraphic{FunnyFrame}]
\defineframedtext[FunnyText] [frame=off,background=FunnyFrame]
\def\StartFrame{\startFunnyText}
\def\StopFrame {\stopFunnyText }
\def\FrameTitle#1%
  {\setMPtext{FunnyFrame}{\hbox spread 1em{\hss\strut#1\hss}}}
\setMPtext{FunnyFrame}{} % initialize the text variable
```

There is a little bit of low level T_EX code involved, like a horizontal box (`\hbox`) that stretches one
em-space beyond its natural size (`spread 1em`) with a centered text (two times `\hss`). Instead of
applying this spread, we could have enlarged the frame on both sides.

In the previous graphic we calculated the big rectangle taking the small one into account. This
was needed because we don't use a background fill. The next definition does, so there we can use
a more straightforward approach by just drawing (and filling) the small rectangle on top of the
big one.

```
\startuseMPgraphic{FunnyFrame}
  picture p ; numeric o ; path a, b ; pair c ;
  p := texttext.rt(\MPstring{FunnyFrame}) ;
  a := unitsquare xyscaled(OverlayWidth,OverlayHeight) ;
  o := BodyFontSize ;
  p := p shifted (2o,OverlayHeight-ypart center p) ;
  drawoptions (withpen pencircle scaled 1pt withcolor .625red) ;
```

```

b := a randomized (o/2) ;
fill b withcolor .85white ; draw b ;
b := (boundingbox p) randomized (o/8) ;
fill b withcolor .85white ; draw b ;
draw p withcolor black;
setbounds currentpicture to a ;
\stopuseMPgraphic

```

Zapf (2)

There is not so much basic instruction, as of now, as there was in the old days, showing the differences between good and bad typographic design.

Because we use a random graphic, we cannot guarantee beforehand that the left and right edges of the small shape touch the horizontal lines in a nice way. The next alternative displaces the small shape plus text so that its center lays on the line. On the average, this looks better.

```

\startuseMPgraphic{FunnyFrame}
picture p ; numeric o ; path a, b ; pair c ;
p := texttext.rt(\MPstring{FunnyFrame}) ;
a := unitsquare xyscaled(OverlayWidth,OverlayHeight) ;
o := BodyFontSize ;
p := p shifted (2o,OverlayHeight-ypart center p) ;
drawoptions (withpen pencircle scaled 1pt withcolor .625red) ;
b := a randomized (o/2) ;
fill b withcolor .85white ; draw b ;
c := center p ;
c := b intersectionpoint (c shifted (0,-o)--c shifted(0,o)) ;
p := p shifted (c-center p) ;
b := (boundingbox p) randomized (o/8) ;
fill b withcolor .85white ; draw b ;
draw p withcolor black;
setbounds currentpicture to a ;
\stopuseMPgraphic

```

Zapf (2)

There is not so much basic instruction, as of now, as there was in the old days, showing the differences between good and bad typographic design.

Yet another definition uses super ellipsed shapes instead of random ones. We need a high degree of superness (.95) in order to make sure that the curves don't touch the texts.

```

\startuseMPgraphic{FunnyFrame}
picture p ; numeric o ; path a, b ; pair c ;
p := texttext.rt(\MPstring{FunnyFrame}) ;
o := BodyFontSize ;
a := unitsquare xyscaled(OverlayWidth,OverlayHeight) ;
p := p shifted (2o,OverlayHeight-ypart center p) ;
drawoptions (withpen pencircle scaled 1pt withcolor .625red) ;

```

```

b := a superellipsed .95 ;
fill b withcolor .85white ; draw b ;
b := (boundingbox p) superellipsed .95 ;
fill b withcolor .85white ; draw b ;
draw p withcolor black ;
setbounds currentpicture to a ;
\stopuseMPgraphic

```

Zapf (3)

Many people are just fascinated by their PC's tricks, and think that a widely-praised program, called up on the screen, will make everything automatic from now on.

There are quite some hard coded values in these graphics, like the linewidths, offsets and colors. Some of these can be fetched from the `\framed` environment either by using \TeX macros or dimensions, or by using their METAFUN counterparts. In the following table we summarize both the available METAPOST variables and their \TeX counterparts. They may be used interchangeably.

METAPOST variable	\TeX command	meaning
OverlayWidth	<code>\overlaywidth</code>	current width
OverlayHeight	<code>\overlayheight</code>	current height
OverlayDepth	<code>\overlayheight</code>	current depth (often zero)
OverlayColor	<code>\MPcolor{\overlaycolor}</code>	background color
OverlayLineWidth	<code>\overlaylinewidth</code>	width of the frame
OverlayLineColor	<code>\MPcolor{}</code>	color of the frame
BaseLineSkip	<code>\the\baselineskip</code>	main line distance
LineHeight	<code>\the\baselineskip</code>	idem
BodyFontSize	<code>\the\bodyfontsize</code>	font size of the running text
StrutHeight	<code>\strutheight</code>	space above the baseline
StrutDepth	<code>\strutdepth</code>	space below the baseline
ExHeight	<code>1ex</code>	height of an x
EmWidth	<code>1em</code>	width of an m-dash

```

\startuseMPgraphic{FunnyFrame}
picture p ; numeric o ; path a, b ; pair c ;
p := texttext.rt(\MPstring{FunnyFrame}) ;
o := BodyFontSize ;
a := unitsquare xyscaled(OverlayWidth,OverlayHeight) ;
p := p shifted (2o,OverlayHeight-y part center p) ;
pickup pencircle scaled OverlayLineWidth ;
b := a superellipsed .95 ;
fill b withcolor OverlayColor ;
draw b withcolor OverlayLineColor ;
b := (boundingbox p) superellipsed .95 ;
fill b withcolor OverlayColor ;
draw b withcolor OverlayLineColor ;
draw p withcolor black ;
setbounds currentpicture to a ;
\stopuseMPgraphic

```

Zapf (3)

Many people are just fascinated by their PC's tricks, and think that a widely-praised program, called up on the screen, will make everything automatic from now on.

We used the following command to pass the settings:

```
\setupframedtexts
[FunnyText]
[backgroundcolor=lightgray,
framecolor=darkred,
rulethickness=2pt,
offset=\bodyfontsize,
before={\blank[big,medium]},
after={\blank[big]},
width=\textwidth]
```

In a real implementation, we should also take care of some additional spacing before the text, which is why we have added more space before than after the framed text.

We demonstrated that when defining graphics that are part of the layout, you need to have access to information known to the typesetting engine. Take figure 4.4. The line height needs to match the font and the two thin horizontal lines should match the x -height. We also need to position the baseline, being the lowest one of a pair of lines, in such a way that it suits the proportions of the line as specified by the strut. A strut is an imaginary large character with no width. You should be aware of the fact that while \TeX works its way top-down, in METAPOST the origin is in the lower left corner.

```
\usetyescript[serif][chorus]
\definefont[SomeHandwriting][TeXGyreChorus-MediumItalic*default at 12pt]
\start \SomeHandwriting\setstrut
\startMPpage
StartPage ;
numeric l, n ; path p ;
l := 1.5LineHeight ;
n := 0 ;
p := origin shifted (l,0) -- origin shifted (PaperWidth-l,0) ;
for i=PaperHeight-1 step -1 until l :
n := n + 1 ;
fill p shifted (0,i+StrutHeight) --
reverse p shifted (0,i-StrutDepth) -- cycle
withcolor .85white ;
draw p shifted (0,i)
withpen pencircle scaled .25pt
withcolor .5white ;
draw p shifted (0,i+ExHeight)
withpen pencircle scaled .25pt
withcolor .5white ;
draw texttext.origin("\strut How are those penalty lines called
in english? I may not steal candies ..." & decimal n)
```



Figure 4.4 Penalty lines.

```

        shifted (1,i)
        shifted (0,-StrutDepth) ;
    endfor ;
    StopPage ;
    \stopMPpage
    \stop

```

This code demonstrates the use of `LineHeight`, `ExHeight`, `StrutHeight` and `StrutDepth`. We set the interline spacing to 1.5 so that we get a bit more loose layout. The variables mentioned are set each time a graphic is processed and thereby match the current font settings.

5 Positional graphics

In this chapter, we will explore one of the more advanced, but also conceptually more difficult, graphic capabilities of `CONTEX`. It took quite a few experiments to find the right way to support these kind of graphics, and you can be sure that in due time extensions will show up. You can skip this chapter if you are no `CONTEX` user. Because we're now a decade into `MKIV` the tricks here will assume that you use `CONTEX` `MKIV` because we have a more convenient interface there. For old-school `MKII` usage you can look in old `METAPOST` manuals or in the `mkii` source files. Of course we remain compatible, it's just that more (convenient) interfaces were added.

5.1 The status quo

After `TEX` has read a paragraph of text, it will try to break this paragraph into lines. When this is done, the result is flushed and after that `TEX` will check if a page should be split off. As a result, we can hardly predict how a document will come out. Therefore, when we want graphics to adapt themselves to this text, maybe even to text broken across lines, we have to deal with this asynchronous feature of `TEX` in a rather advanced way. Before we present a way of dealing with this complexity, we will elaborate on the nature of embedded graphics in `TEX`.

When `TEX` entered the world of typesetting, desktop printers were not that common, let alone color desktop printers. But times have changed and nowadays we want color and graphics and if possible we want them integrated in the text. When `METAPOST` showed up it depended on the `DVI` processor to recognize the `POSTSCRIPT` code as being produced by `METAPOST` and therefore also include the fonts that were used. But color was still limited to `RGB`. When `PDFTEX` evolved I wrote an interpreter (in `TEX`) that could translate the output to `PDF`. This also opened up the possibility to add features to `METAPOST`, like `CMYK` colors, shading, transparencies etc. But basically the `TEX` and `METAPOST` processes were rather isolated. We could of course pass information to `METAPOST` and pick up information from `METAPOST` in a second pass. That has changed in `LUATEX`.

In order to really integrate `METAPOST` graphics into the flow you need to know where you are on the page and how large graphics should be, especially when you want them to depend on the layout. A first solution to this was to embed specials in the `DVI` that could later be used to extract positions. In retrospect this was a relative trivial extension, something that could have been around much earlier but somehow didn't happen. Anyhow, after some experiments `PDFTEX` got a native position tracker which meant that no post processor was needed. Of course `LUATEX` inherited this feature too. Because positioning is rather bound to the macro package reading this chapter only makes sense when you use `CONTEX`.

5.2 The concept

Because we have a `LUA` connection in `MPLIB`, we have implemented a couple of helpers that make live easier. This is also why the following examples are `MKIV` specific, although `MKII` can do the same, but with a bit different set of helpers. We can for instance query properties of `positions` without using `TEX` macros but can use `METAPOST` macros instead. Let's give an example. The background and frame behind the word `position` in this paragraph is not done with `\framed` but using a different mechanism:

```
to get \hpos {A-0} {positions} sorted
```

The `\hpos` refers to a position and we have bound that position to a graphic:

```
\setMPpositiongraphic{A-0}{mpos:box}{self=A-0}
```

The graphic itself is defined with:

```
\startMPpositiongraphic{mpos:box}{fillcolor,linecolor,linewidth}
  string tag; tag := "\MPvar{self}" ;
  path box ; box := positionbox(tag) ;
  box := box enlarged \MPvar{filloffset} ;
  fill box
    withcolor \MPvar{fillcolor} ;
  draw box
    withcolor \MPvar{linecolor}
    withpen pencircle scaled \MPvar{linewidth} ;
  positioninregion ;
\stopMPpositiongraphic
```

A variant that has no macro calls and does all via the LUA intercaface in MKIV is the following:

```
\startMPpositiongraphic{mpos:box}{fillcolor,linecolor,linewidth}
  path box ; box := positionbox(texstr("self")) ;
  box := box enlarged texvar("filloffset") ;
  fill box
    withcolor texvar("fillcolor") ;
  draw box
    withcolor texvar("linecolor")
    withpen pencircle scaled texvar("linewidth") ;
  positioninregion ;
\stopMPpositiongraphic
```

A `\hpos` position has several properties: the coordinates of the origin: `x` and `y`, the dimensions of the boxed content, `w`, `h` and `d`, and the page number `p`. An additional helper `positioninregion` will move the drawing to the right spot in the region. Examples or regions are the page, text area or some overlay. The `positionatanchor` variant relocates to the anchor of the given tag. The first helper is actually a shortcut for:

```
currentpicture := currentpicture shifted - positionxy(positionanchor) ;
```

In our case we use a dedicated layer `backgraphics` that we have hooked into the page backgrounds:

```
\setupbackgrounds
  [page]
  [background={backgraphics,foreground,foregraphics}]

\defineoverlay [backgraphics] [\positionoverlay{backgraphics}]
\defineoverlay [foregraphics] [\positionoverlay{foregraphics}]
```

The relation between position graphics and that layer are defined as follows (we will come back to this in a moment):

```
\setupMPvariables
  [mpos:box]
  [linecolor=blue,
```

```

linewidth=\linewidth,
fillcolor=lightgray,
filloffset=2pt]

\setupMPvariables[mpos:box][linecolor=darkred]
\setupMPvariables[mpos:par][linecolor=darkred]

\startpositionoverlay{backgraphics}
  \setMPpositiongraphic{A-0}{mpos:box}{self=A-0}
  \setMPpositiongraphic{A-3}{mpos:box}{self=A-3}
  \setMPpositiongraphic{A-4}{mpos:box}{self=A-4}
\stoppositionoverlay

```

5.3 A more detailed view

As we know, a decent portion of \TeX 's attention is focused on breaking paragraphs into lines and determining the optimal point to split off the page. Trying to locate the optimal points to break lines is a dynamic process. The space between words is flexible and we don't know in advance when a word or piece of a word—maybe it's best to talk of typographic globs instead—will end up on the page. It might even cross the page boundary.

In the previous section we saw `word` and `globs` encircled and connected by an arrow. This graphic can be drawn only when the position and dimensions are known. Unfortunately, this information is only available after the paragraph is typeset and the best breakpoints are chosen. Because the text must be laid on top of the graphic, the graphic must precede the first word in the typeset stream or it must be positioned on a separate layer. In the latter case it can be calculated directly after the paragraph is typeset, but in the former case a second pass is needed. Because such graphics are not bound to one paragraph, the multi-pass option suits better because it gives us more control: the more we know about the final state, the better we can act upon it. Think of graphics on the first page that depend on the content of the last page or, as in this paragraph, backgrounds that depend on the typeset text.

The arrows that connect the shapes are drawn with the following code that now looks familiar:

```

\startMPpositionmethod{mypos:arrow}
  \startMPpositiongraphic{mypos:arrow}
    save pa, pb, pm, pab, na, nb, sa, sb ;
    path pa, pb, pm, pab ; numeric na, nb ; string sa, sb ;
    % the tags
    sa := texstr("from") ;
    sb := texstr("to") ;
    % we need to check page crossing so we fetch the page numbers
    na := positionpage(sa) ;
    nb := positionpage(sb) ;
    % we use the repositioned shapes
    pa := positionbox(sa) ;
    pb := positionbox(sb) ;
    % but want circles instead of rectangles
    pa := llcorner pa .. lrcorner pa .. urcorner pa .. ulcorner pa .. cycle ;
    pb := llcorner pb .. lrcorner pb .. urcorner pb .. ulcorner pb .. cycle ;
    pickup pencircle scaled 1pt ;
    if na = nb :

```

```

% both are on the same page
fill pa withcolor .800white ;
fill pb withcolor .800white ;
draw pa withcolor .625yellow ;
draw pb withcolor .625yellow ;
pm := .5[center pa,center pb] shifted (0,2*LineHeight) ;
pab := center pa .. pm .. center pb ;
pab := pab cutbefore (pab intersectionpoint pa) ;
pab := pab cutafter (pab intersectionpoint pb) ;
drawarrow pab dashed evenly withcolor .625red ;
positionatanchor(sa) ;
elseif nb < na :
% they are on different pages and we're at the first one
fill pb withcolor .800white ;
draw pb withcolor .625yellow ;
pab := center pb {up} .. ulcorner bbox pb ;
pab := pab cutbefore (pab intersectionpoint pb) ;
drawarrow pab dashed evenly withcolor .625red ;
positionatanchor(sb) ;
else :
% they are on different pages and we're at the last one
fill pa withcolor .800white ;
draw pa withcolor .625yellow ;
pab := center pa {up} .. urcorner bbox pa ;
pab := pab cutbefore (pab intersectionpoint pa) ;
drawarrow pab dashed evenly withcolor .625red ;
positionatanchor(sa) ;
fi ;
\stopMPpositiongraphic
% we put it here at the first position
\MPpositiongraphic{mypos:arrow}
% we need to carry information forward and make sure that we also
% check and flush at the second position of the pair
\ifnum\MPp{\MPvar{from}}<\MPp{\MPvar{to}}\relax
\expanded{\setMPpositiongraphic{\MPvar{to}}{mypos:arrow}{to=\MPvar{from}}}
\fi
\stopMPpositionmethod

```

and

```
\setMPpositiongraphic{A-1}{mypos:arrow}{to=A-2}
```

However, here we anchor at one of the positions because we don't flush in a layer but at the position itself. Indeed it looks complex.

It may be clear now that we need some positional information in order to provide features like the ones shown here. The fact that we will act upon in a second pass simplifies the task, although it forces us to store the positional information between runs in some place. This may look uncomfortable at first sight, but it also enables us to store some additional information. Now why is that needed?

A position has no dimensions, it's just a place somewhere on the page. In order to do tricks like those shown here, we also need to know the height and depth of lines at a specific point as well as the width of the box(es) we're dealing with. In the encircled examples, the dimensions of the box following the positional node are stored along with the position.

In order to process the graphics, we tag each point with a name, so that we can attach actions to those points. In fact they become trigger points. As we will demonstrate, we also need to store the current page number. This brings the data stored with a point to:

```
<identifier> <pagenumber> <x> <y> <width> <height> <depth>
```

Actually we store more information, for example the region in which the positions sit. Depending on the use we can also get access to paragraph and line properties but discussing these is beyond this manual. These are for instance used in the text backgrounds.

The page number is needed in order to let the graphics engine determine boundary conditions. Backgrounds like those shown here can span multiple pages. In order to calculate the right backgrounds, some additional information must be available, like the top and bottom of the current text area. In fact, these are just normal points that can be saved while processing the split off page. So, apart from positioning anchors in the text we need anchors on crucial points of the layout. This means that this kind of support cannot be fully integrated into the \TeX kernel, unless we also add extensive support for layout definitions, and that is probably not what we want.

As soon as something like (x, y) shows up, a logical question is where $(0, 0)$ is located. Although this is a valid question, the answer is less important than you may expect. Even if we know that $(0, 0)$ is 'officially' located in the bottom left corner of the page, the simple fact that in \CONTEX T we are dealing with a mixed page concept, like paper size and print paper size, or left and right pages, forces us to think in relative positions instead of absolute ones. Therefore, graphics, even those that involve multiple positions, are anchored to a position on the layer on which they are located.

Users who simply want to use these features may wonder why we go into so much detail. The main reason is that in the end many users will want to go beyond the simple cases, and when dealing with these issues, you must be aware not only of height, depth and width, but also of the crossing of a page boundary, and the height and depth of lines. In some cases your graphics may have to respond to layout characteristics, like differences between odd and even pages. Given that unique identifiers are used for anchor points, in \CONTEX T you can have access to all the information needed. Here are some of the helpers:

<code>positionpath (tag)</code>	the path determined by width, height and depth
<code>positionxy (tag)</code>	the origin
<code>positionwhd (tag)</code>	the dimensions (in a triplet)
<code>positionpage (tag)</code>	the page number fo the position
<code>positionregion(tag)</code>	the region that the position sits in
<code>positionbox (tag)</code>	the positioned box (path shifted over coordinates)
<code>positionanchor</code>	the current anchor of the region

The `positionwhd` macro returns a triplet that you can query, like:

```
triplet whd ; whd := positionwhd("\MPvar{from}");
numeric wd; wd := wdpart whd ;
```

We will add more such convenient helpers in the future. In the \CONTEX T distribution you can find examples (in manuals or librarties) that demonstrate other tricks with positioning.

5.4 Anchors and layers

In a previous section we saw that some words were circled and connected by an arrow. As with most things in `CONTEXT`, marking these words is separated from declaring what to do with those words. This paragraph is keyed in as:

```
In a previous section we saw that some \hpos {X-1} {words} were
\hpos {X-2} {circled} and connected by an \hpos {X-3} {arrow}.
As with most things in \CONTEXT, marking these words is separated
from declaring what to do with those words. This paragraph is keyed
in as:
```

We see three position anchors, each marked by an identifier: `X-1`, `X-2` and `X-3`. Each of these anchors can be associated with a (series) of graphic operations. Here we defined:

```
\setMPpositiongraphic{X-1}{mypos:arrow}{to=X-2}
\setMPpositiongraphic{X-2}{mypos:arrow}{to=X-3}
```

These examples clearly demonstrate that we cannot control to what extent graphics will cover text and vice versa. A solution to this problem is using position overlays. We can define such an overlay as follows:

```
\startpositionoverlay{backgraphics}
  \setMPpositiongraphic{G-1}{mypos:circle}
  \setMPpositiongraphic{G-2}{mypos:circle}
  \setMPpositiongraphic{G-3}{mypos:circle}
  \setMPpositiongraphic{G-4}{mypos:circle}
\stoppositionoverlay

\startpositionoverlay{foregraphics}
  \setMPpositiongraphic{G-1}{mypos:line}{to=G-2}
  \setMPpositiongraphic{G-2}{mypos:line}{to=G-3}
  \setMPpositiongraphic{G-3}{mypos:line}{to=G-4}
\stoppositionoverlay
```

First we have defined an overlay. This overlay can be attached to some overlay layer, like, in our case, the page. We define four small circles. These are drawn as soon as the page overlay is typeset. Because they are located in the background, they don't cover the text, while the lines do. The previous paragraph was typeset by saying:

```
First we have defined an \hpos {G-1} {\strut overlay}. This
overlay can be attached to some overlay layer, like, in our
case, the \hpos {G-2} {\strut page}. We define four small \hpos
{G-3} {\strut circles}. These are drawn as soon as the page
overlay is typeset. Because they are located in the
background, they don't cover the \hpos {G-4} {\strut text}, while
the lines do. The previous paragraph was typeset by saying:
```

As said, the circles are on the background layer, but the lines are not! They are positioned on top of the text. This is a direct result of the definition of the page background:

```
\defineoverlay [foregraphics] [\positionoverlay{foregraphics}]
\defineoverlay [backgraphics] [\positionoverlay{backgraphics}]
```



```
\setupbackgrounds
  [page]
  [background={backgraphics,foreground,foregraphics}]
```

In this definition, the predefined overlay `foreground` inserts the page data itself, so the foreground graphics end up on top. This example also demonstrates that you should be well aware of the way `CONTEXT` builds a page. There are six main layers, in some cases with sublayers. The body text goes into the main text layer, which, unless forced otherwise, lays on top.

- | | | |
|---------------------|---------------------|---------------|
| 1. paper background | 3. page backgrounds | 5. logo areas |
| 2. area backgrounds | 4. text areas | 6. main text |

The paper background is used for special (sometimes internal) purposes. There are three page backgrounds: left, right and both. The text areas, logo areas and backgrounds form a 5×5 matrix with columns containing the `leftedge`, `leftmargin`, `text`, `rightmargin`, and `rightedge`. The rows of the matrix contain the `top`, `header`, `text`, `footer`, and `bottom`. The main text is what you are reading now.

Since the page background is applied last, the previous layers can be considered to be the foreground to the page background layer. And, indeed, it is available as an overlay under the name `foreground`, as we already saw in the example. Foregrounds are available in most cases, but (for the moment) not when we are dealing with the text area. Since anchoring the graphics is implemented rather independent of the position of the graphics themselves, this is no real problem, we can put them all on the page layer, if needed in separate overlays.

How is such a graphic defined? In fact these graphics are a special case of the already present mechanism of including `METAPOST` graphics. The circles are defined as follows:

```
\startMPpositiongraphic{mypos:circle}
  path p ; p := positionbox(texstr("self")) ;
  p := fullcircle xsized (bbwidth(p)+4pt) shifted center p ;
  pickup pencircle scaled 1pt ;
  fill p withcolor .800white ;
  draw p withcolor .625yellow ;
  positioninregion ;
\stopMPpositiongraphic
```

Drawing the lines is handled in a similar fashion.

```
\startMPpositiongraphic{mypos:line}
  path pa, pb, pab ; numeric na, nb ; string ta, tb ;
  ta := texstr("from") ;
  tb := texstr("to") ;
  na := positionpage(ta) ;
  nb := positionpage(tb) ;
  pa := positionbox(ta) ;
  pb := positionbox(tb) ;
  pa := fullcircle xsized (bbwidth(pa)+4pt) shifted center pa ;
  pb := fullcircle xsized (bbwidth(pb)+4pt) shifted center pb ;
  if na = nb :
    pab := center pa -- center pb ;
    pab := pab cutbefore (pab intersectionpoint pa) ;
```

```

    pab := pab cutafter (pab intersectionpoint pb) ;
    pickup pencircle scaled 1pt ;
    draw pab withcolor .625yellow ;
    positioninregion ;
  fi ;
\stopMPpositiongraphic

```

The command `\startMPpositiongraphic` defines a graphic, in this example we have called it `mypos:circle`. Here we show the definition out of order but normally you need to define it before you refer to it.

The METAPOST macro `positionbox` returns a box that is constructed from the coordinates and dimensions. After this call, the corners are available via `llcorner`, `lrcorner`, `urcorner` and `ulcorner`. The center is accessible by `center`. When we are finished drawing the graphic, we can anchor the result with `positioninregion`. This macro automatically handles positioning on specific layers. The helper macros are not loaded by default, you do that with:

The position macro `\MPpos` returns the current characteristics of a position. The previously defined G positions return:

position	page	x	y	width	height	depth
G-1	160	197.06801pt	291.66295pt	31.97000pt	9.05186pt	3.52016pt
G-2	160	124.32999pt	279.09093pt	21.15999pt	9.05186pt	3.52016pt
G-3	160	243.08192pt	279.09093pt	27.68001pt	9.05186pt	3.52016pt
G-4	160	382.71893pt	266.51891pt	16.46999pt	9.05186pt	3.52016pt

The numbers represent the real pagenumber p , the current position (x, y) , and the dimensions of the box (w, h, d) if known. These values are fed directly into METAPOST graphics but the individual components can be asked for by `\MPp`, `\MPx`, `\MPy`, `\MPw`, `\MPh` and `\MPd`.

In the previous definition of the graphic, we saw another macro, `\MPvar`. When we invoke a graphic or attach a graphic to a layer, we can pass variables. We can also set specific variables in other ways, as we will see later.

```

\setMPpositiongraphic{G-1}{mypos:circle}
\setMPpositiongraphic{G-1}{mypos:line}{to=G-2}

```

In the second definition, we let the variable `to` point to another position. When needed, we can ask for the value of `to` by `\MPvar{to}`. For reasons of convenience, the current position is assigned automatically to `from` and `self`. This means that in the line we saw in the graphic:

```

path p ; p := positionbox(texstr("self")) ;

```

`texstr("self")` will return the current position, which, fed to `positionbox` will return a box with the right dimensions. We already warned the reader: this is not an easy chapter.

5.5 More layers

Overlays are one of the nicer features of `CONTEXT` and even more nice things can be build on top of them. Overlays are defined first and then assigned to framed boxes using the `background` variable.

You can stack overlays, which is why they are called as such. You can use the special overlay called `foreground` to move the topmost (often text) layer down in the stack.

background overlay	a text, graphic, hyperlink or widget
position overlay	a series of macros triggered by positions
background layer	a box that can hold boxes with offsets

The last kind of layer can be used in other situations as well, but in most cases it will be hooked into a background overlay.

```
\definelaye[MyLayer] [option=test]
\setupbackgrounds [text] [leftmargin] [background=MyLayer]
\setlayer [MyLayer] [x=.5cm,y=5cm]
  {\rotate{\framed{This goes to the background}}}
```

This goes to the background

In this case the framed text will be placed in the background of the (current) page with the given offset to the topleft corner. Instead of a fixed position, you can inherit the current position using the `position` directive. Say that we have a layer called `YourLayer` which we put in the background of the text area.

```
\definelaye[YourLayer]
\setupbackgrounds [text] [text] [background=YourLayer]
```

We can now move some framed text to this layer using `\setlayer` with the directive `position` set to `yes`.

```
here: \setlayer [YourLayer] [position=yes]{\inframed{Here}}
```

You can influence the placement by explicitly providing an offset (`hoffset` and/or `voffset`), a position (`x` and/or `y`) or a location directive (`location`). Normally you will use the offsets for the layer as a whole and the positions for individual contributions. The next example demonstrates the use of a location directive.

```
here: \setlayer [YourLayer] [position=yes,location=c]{\inframed{Here}}
```

here:

Many layers can be in use at the same time. In the next example we put something in the page layer. By default, we turn on position tracking, which visualizes the bounding box of the content and shows the reference point.



```
\definelaye [BackLayer] [position=yes]
\setupbackgrounds [page] [background=BackLayer]
```

Next we define an overlay that we can put behind for instance framed texts. We use METAPOST to draw `Shape`.

```
\defineoverlay [Shape] [BackLayer] [\uniqueMPgraphic{Shape}]
\startuniqueMPgraphic{Shape}
  path p ; p := fullcircle xyscaled(OverlayWidth,OverlayHeight) ;
  fill p withcolor \MPcolor{lightgray} ;
  draw p withpen pencircle scaled 1pt withcolor \MPcolor{darkred} ;
\stopuniqueMPgraphic
```

We can now put this background shape behind the running text, for instance with:



```
.... some \inframed[background=Shape]{text} with a frame ...
.... some \Shaped{text} with a frame ...
```

.... some  with a frame ...
 some  with a frame ...

The `\Shaped` macro was defined as:

```
\defineframed[Shaped] [background=Shape,frame=off,location=low]
```

Watch how the graphics are moved to the background while the frame of the first text stays on top, since it remains part of the text flow.

.... some  with a frame ...
 some  with a frame ...

In the previous instance of the example we have reversed the stacking. Reversal can be done with the `direction` directive.

```
\setuplayer[BackLayer] [direction=reverse]
```

You can influence the placement of a background component by using a different anchor point.

```
\setuplayer
  [BackLayer]
  [position=no,corner=bottom,height=\paperheight]
\setlayer[BackLayer] [x=2cm,y=10cm,location=bl]
  {\externalfigure[somecow.pdf] [width=1cm]}
\setlayer[BackLayer] [x=1cm,y=8cm,location=br]
  {\externalfigure[somecow.pdf] [width=1cm]}
\setlayer[BackLayer] [x=2cm,y=4cm,location=tl]
  {\externalfigure[somecow.pdf] [width=1cm]}
\setlayer[BackLayer] [x=10cm,y=1cm,location=tr]
  {\externalfigure[somecow.pdf] [width=1cm]}
```



Instead of using relative positions, you can also use absolute ones. Of course you need to know how your coordinates relate to the rest of the layout definition.



```
\setuplayer
  [BackLayer]
  [position=no,corner=bottom,height=\paperheight]
\setlayer[BackLayer] [x=15cm,y=5cm,location=bl]
  {\externalfigure[somecow.pdf] [width=3cm]}
\setlayer[BackLayer] [x=15cm,y=5cm,location=br]
  {\externalfigure[somecow.pdf] [width=3cm]}
\setlayer[BackLayer] [x=15cm,y=5cm,location=tl]
  {\externalfigure[somecow.pdf] [width=2cm]}
```



```
\setlayer[BackLayer][x=15cm,y=5cm,location=tr]
{\externalfigure[somecow.pdf][width=2cm]}

\setlayer[BackLayer][x=15cm,y=5cm,location=c]
{\externalfigure[somecow.pdf][width=3cm]}
```

These examples again demonstrate how we can influence the placement by assigning an anchor point to position. Here we also put the reference point in the lower left corner (bottom). This mechanism only works when we also use height.

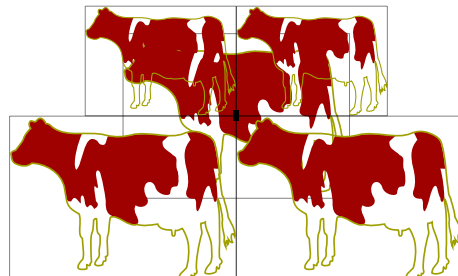

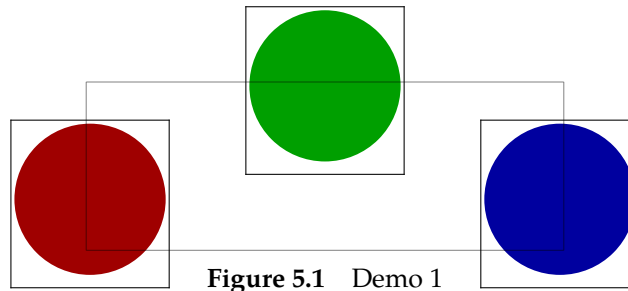

One of the reasons for developing the layer mechanism was that we needed to slightly change the position of figures in the final stage of typesetting. The previous pages demonstrate how one can position anything anywhere on the page, but in the case of figures the position may depend on where the text ends up on the page.

Normally, when you manipulate a document this way, you are in the final stage of typesetting. You may qualify this as desk top publishing without actually using a desktop.

```

\definelaye
  [DemoLayer]
  [position=yes]

\startplacefigure[title={Demo 1}]
  \ruledhbox\bgroup
    \setlayerframed
      [DemoLayer] [hoffset=-10mm,voffset=5mm]
      {\startMPcode
        fill fullcircle scaled 2cm withcolor .625red ;
        \stopMPcode}%
    \setlayerframed
      [DemoLayer] [voffset=-10mm]
      {\startMPcode
        fill fullcircle scaled 2cm withcolor .625green ;
        \stopMPcode}%
    \setlayerframed
      [DemoLayer] [hoffset=10mm,voffset=5mm]
      {\startMPcode
        fill fullcircle scaled 2cm withcolor .625blue ;
        \stopMPcode}%
  \egroup
\stopplacefigure

```

The previous example also demonstrated the use of METAPost for rotating the picture. The `\MPfigure` macro encapsulates the code in a shortcut. You can achieve special effects by using the layers behind floating bodies and alike, but always keep in mind that the readability of the text should not be violated too much.

```

\startbuffer
\setlayer [DemoLayer]
  [position=yes,
  voffset=-1.5cm,

```

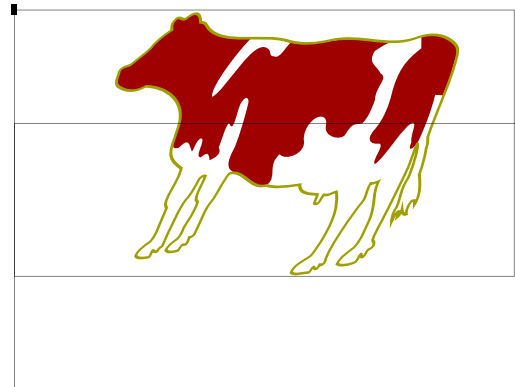

Figure 5.2

```

width=3cm,
height=2cm]
{\MPfigure{somecow.pdf}{scaled .5 slanted .5}}
\stopbuffer

\placefigure[right]{\ruledhbox{\getbuffer}}

```

In these examples we added a `\ruledhbox` around the pseudo graphics so that you can see what the size is of those graphics.

We have already seen a lot of parameters that can be used to control the content of a layer. There are a few more. General housekeeping takes place with:

state	start	enable the layer
	stop	disable the layer
position	no	use absolute positions
	yes	use relative positions
	overlay	idem, but ignore the size
direction	normal	put new data on top
	reverse	put new data below old data

Sometimes all data needs to be offset in a similar way. You can use both offset parameters for that.

hoffset	an additional horizontal displacement
voffset	an additional vertical displacement

You can position data anywhere in the layer. When positioning is turned on, the current position will get a placeholder. You can change the dimensions of that placeholder (when `position` is set to `overlay`), zero dimensions are used.

x	the horizontal displacement
y	the vertical displacement
width	the (non natural) width
height	the (non natural) height
location	l r t b c lt lb rt rb

The `location` directive determines what point of the data is used as reference point. You can keep track of this point and the placement when you enable test mode. This is how the rectangles in the previous examples were drawn.

option	test	show positioning information
--------	------	------------------------------

When you are enhancing the final version of a document, you can explicitly specify on what page the data will go. Use this option with care.

page	the page where the data will go
------	---------------------------------

Because layers can migrate to other pages, they may disappear due to the background not being recalculated. In case of doubt, you can force repetitive background calculation by:

```
\setupbackgrounds[state=repeat]
```

5.6 Complex text in graphics

If you like to embed METAPOST snippets in `CONTEXT`, you may want to combine text and graphics and let METAPOST provide the position and the dimensions of the text to be typeset outside by `TEX`. For most applications using the `METAFUN` `texttext` macro works well enough, but when the typeset text needs to communicate with the typesetting engine, for instance because it contains hyperlinks or references, you can use the following method:

- define a layer
- define a (reusable) graphic
- put your text into the layer
- combine the graphic with the text

You must be aware of the fact that when the layer is flushed, its content is gone. You can take advantage of this by using the same graphic with multiple texts.

```
\definelayer[test]
```

You don't need to pass the width and height explicitly, but when you do so, you have access to them later.

```
\startuseMPgraphic{oeps}
  path p ; p := fullcircle scaled 6cm ;
  fill p withcolor .8white ;
  draw p withpen pencircle scaled 1mm withcolor .625red ;
  register ("somepos-1",0cm,0cm,center currentpicture) ;
  register ("somepos-2",3cm,1cm,(-1cm,-1cm)) ;
  register ("somepos-3",2cm,0cm,(-2cm,2cm)) ;
\stopuseMPgraphic
```

The `METAFUN` `register` macro takes the following arguments:

```
register ("tag",width,height,(x offset,y offset)) ;
```

The width and height are available in the macros `\MPlayerwidth` and `\MPlayerheight` and are equivalent to `\MPw{tag}` and `\MPh{tag}`,

```
\setMPlayer [test] [somepos-1] [location=c]
  {Does it work al right?}

\setMPlayer [test] [somepos-2]
  {\framed
   [width=\MPlayerwidth,height=\MPlayerheight,
   background=color,backgroundcolor=white]
  {It Works!}}
```

```
\setMPlayer [test] [somepos-3]
  {\externalfigure[cow-fun.mps] [width=2cm]}
```

Combining the graphic and the text is handled by the macro `\getMPlayer`.

```
\getMPlayer [test] {\useMPgraphic{oeps}}
```



The macro `\getMPlayer` is built on top of `\framed`. The settings passed in the (optional) second argument are the same as those to `\framed`.

```
\getMPlayer
 [test]
 [frame=on,offset=5pt]
 {\useMPgraphic{oeps}}
```

As you see, you need a bit of a twisted mind to handle graphics this way, but at least the functionality is there to create complex graphics in a declarative way.

6 Page backgrounds

Especially in interactive documents, adding backgrounds to the page and text areas not only enhances readability, but also makes it more convenient to identify header, footers and navigational areas. In this chapter we will demonstrate that with METAPOST we can go beyond the T_EX based features present in CONTEX_T. One section is dedicated to graphics and printing, especially bleeding.

6.1 The basic layout

In the CONTEX_T manual you can find many details on the composition of the page. When T_EX typesets text, crossing the page boundary triggers T_EX's output routine. This routine is responsible for pasting the body text that goes onto a page in the correct area. A simple representation of such a page is:

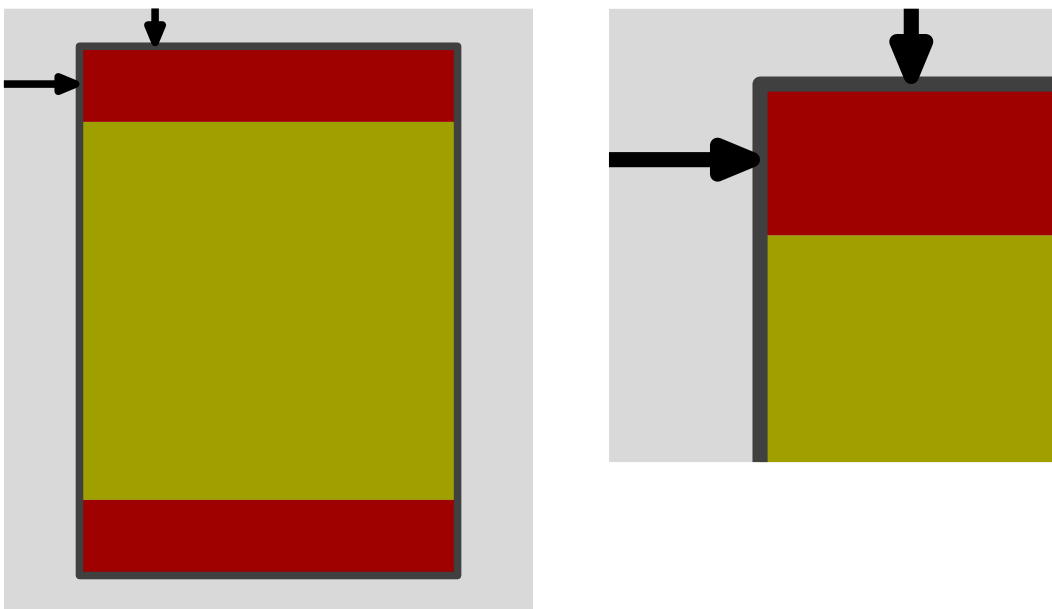

The red areas are the header and footer, while the yellow areas contains the text flow. We can turn headers on and off and/or hide them. For this reason, the header, text and footer areas together make up the height of the text.

A close look at the left picture will reveal that the two arrows point to the center of the lines. This is achieved by the `top` and `lft` directives. If we would not have clipped the picture, the arrow would have stuck half a line width outside the gray area that represents the page. When constructing such pictures, one should really pay attention to such details, since it pays off in the overall look and feel of the document.

The vertical arrow represents the top space, while the horizontal arrow denotes the distance to the back of the cover (back space). By changing their values, you can shift the main body text on the page. In a double sided layout scheme, the back space is automatically mirrored on even pages.

An advanced METAPOST user may wonder why we hard code the dimensions, and avoid METAPOST's powerful mechanisms for defining relations. Our experience has taught us that in pictures like this, providing a general solution seldom pays large dividends or savings in time.

```

\startuseMPgraphic{layout 1}
  pickup pencircle scaled 1mm ;
  fill unitsquare xyscaled (7cm,8cm)
    withcolor .85white ;
  fill unitsquare xyscaled (5cm,5cm) shifted (1cm,1.5cm)
    withcolor .625yellow ;
  fill unitsquare xyscaled (5cm,1cm) shifted (1cm,.5cm)
    withcolor .625red ;
  fill unitsquare xyscaled (5cm,1cm) shifted (1cm,6.5cm)
    withcolor .625red ;
  draw unitsquare xyscaled (5cm,7cm) shifted (1cm,.5cm)
    withcolor .25white ;
  drawarrow (2cm,8cm) -- top (2cm,7.5cm) ;
  drawarrow (0cm,7cm) -- lft (1cm,7cm) ;
  clip currentpicture to unitsquare xyscaled (7cm,8cm) ;
\stopuseMPgraphic

```

As you can see, the left graphic is defined as a series of rectangles. The `xyscaled` macro is part of the `CONTEX` files, and saves some typing and space. It is defined as a primary, requiring both left and right operands.

```

primarydef p xyscaled q =
  p xscaled (xpart q) yscaled (ypart q)
enddef ;

```

Zooming in on the top left corner only takes a few lines. First we clip the correct part, next we scale it up, and finally we let the bounding box suit the left picture.

```

\startuseMPgraphic{layout 2}
  \includeMPgraphic{layout 1}
  clip currentpicture to unitsquare scaled 3cm shifted (0,5cm) ;
  currentpicture := currentpicture scaled 2 shifted (0,-8cm) ;
  setbounds currentpicture to unitsquare xyscaled (6cm,8cm) ;
\stopuseMPgraphic

```

This code demonstrates how you can reuse a graphic inside another one. This strategy can easily be used to stepwise build (or extend) graphics. The two graphics were put side by side with the following command. Watch the use of line correction commands. They optimize the white space around the graphic.

```

\startlinecorrection[blank]
\hbox
  {\useMPgraphic{layout 1}\hskip1cm
  \useMPgraphic{layout 2}}
\stoptlinecorrection

```

As soon as you want to make an electronic document, you will want to use different areas of the screen for different purposes: text, menus, buttons, etc. For this reason, `CONTEX` provides not only left and right margins, but also additional left and right edge areas and top and bottom margins. These areas are shown in the figure on the next page.

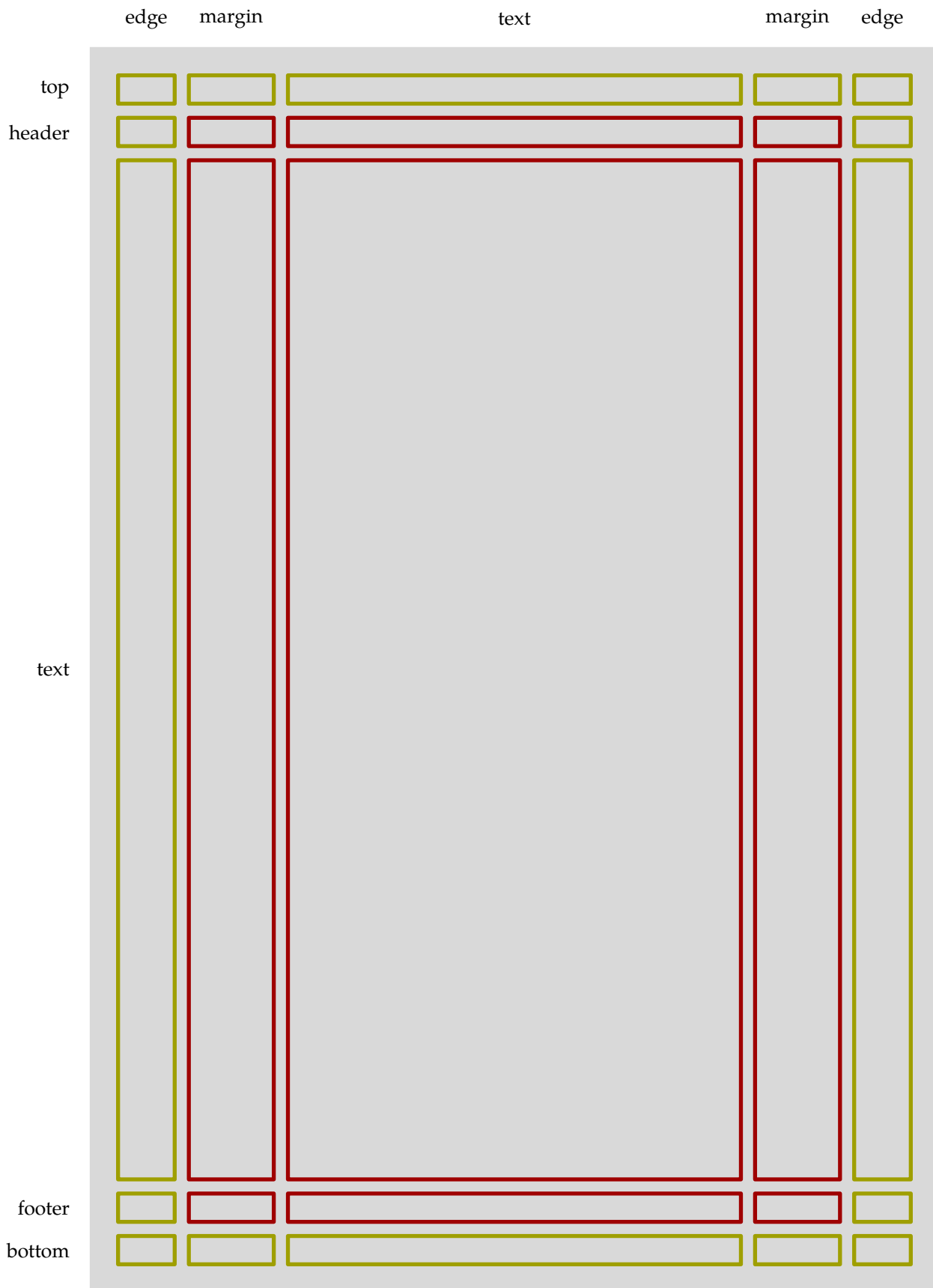

When defining this graphic, all areas have related dimensions. Here it makes sense to let METAPOST calculate these dimensions as much as possible. First we define the five by five matrix of areas. We pass the width and height of the main text area. Because they are stored in $\text{T}_{\text{E}}\text{X}$ dimension registers, we have to prefix them by `\the`.

```
pickup pencircle scaled 2pt ;
numeric w[], h[], x[], y[], u ; u := .5cm ;
numeric width ; width := \the\textwidth ;
numeric height ; height := \the\textheight ;
```

We now specify the lower left corners using `=` instead of the `:=`, which means that METAPOST will calculate `w[3]` and `h[3]` for us.

```
w[1] = 2u ; w[2] = 3u ; w[4] = 3u ; w[5] = 2u ;
h[1] = 1u ; h[2] = 1u ; h[4] = 1u ; h[5] = 1u ;

w[1]+w[2]+w[3]+w[4]+w[5]+4u = width ;
h[1]+h[2]+h[3]+h[4]+h[5]+4u = height ;

x[1] = 1u ; y[1] = 1u ;
x[2] = x[1] + w[1] + .5u ; y[2] = y[1] + h[1] + .5u ;
x[3] = x[2] + w[2] + .5u ; y[3] = y[2] + h[2] + .5u ;
x[4] = x[3] + w[3] + .5u ; y[4] = y[3] + h[3] + .5u ;
x[5] = x[4] + w[4] + .5u ; y[5] = y[4] + h[4] + .5u ;
```

Because we are going to repeat ourselves, we draw the areas using a macro. Depending on its importance, we color it red or yellow.

```
def do_it (expr xx, yy, cc) =
  draw unitsquare
    xyscaled (w[xx],h[yy]) shifted (x[xx],y[yy])
    withcolor if cc : .625red else : .625yellow fi ;
enddef ;

fill unitsquare xyscaled (width,height) withcolor .85white;
do_it (1,1,false) ; do_it (5,1,false) ;
do_it (2,1,false) ; do_it (3,1,false) ; do_it (4,1,false) ;

do_it (1,2,false) ; do_it (5,2,false) ;
do_it (2,2,true ) ; do_it (3,2,true ) ; do_it (4,2,true ) ;

do_it (1,3,false) ; do_it (5,3,false) ;
do_it (2,3,true ) ; do_it (3,3,true ) ; do_it (4,3,true ) ;

do_it (1,4,false) ; do_it (5,4,false) ;
do_it (2,4,true ) ; do_it (3,4,true ) ; do_it (4,4,true ) ;

do_it (1,5,false) ; do_it (5,5,false) ;
do_it (2,5,false) ; do_it (3,5,false) ; do_it (4,5,false) ;
```

This picture in itself is not yet explanatory, so we add some labels. Again, we use a macro, which we feed with a picture generated by $\text{T}_{\text{E}}\text{X}$. Since these pictures are filtered from the source and pre-

processed, we cannot embed the `btex–etex` in the macro `do_it` and pass a string. It has to be done this way.¹¹

```
def do_it (expr yy, tt) =
  path p ;
  p := unitsquare xyscaled (w[1],h[yy]) shifted (x[1],y[yy]) ;
  label.lft(tt, center p shifted (-w[1]/2-u-.25cm,0)) ;
enddef ;

do_it (1,btex bottom etex) ;
do_it (2,btex footer etex) ;
do_it (3,btex text etex) ;
do_it (4,btex header etex) ;
do_it (5,btex top etex) ;
```

In the horizontal direction we have edges, margins and text. There are left and right edges and margins, which are swapped on even pages when you typeset a double sided document.

```
def do_it (expr xx, tt) =
  path p ;
  p := unitsquare xyscaled (w[xx],h[1]) shifted (x[xx],y[1]) ;
  label(tt, center p shifted (0,height-h[1]/2)) ;
enddef ;

do_it (1,btex edge etex) ;
do_it (2,btex margin etex) ;
do_it (3,btex text etex) ;
do_it (4,btex margin etex) ;
do_it (5,btex edge etex) ;
```

Since we want the graphic to match the dimensions of the text area of the current page, we have to make sure that the bounding box is adapted accordingly. By this action, the labels will fall outside the bounding box. When we directly embed a graphic, this works ok, but when we start scaling and reusing, due to the object reuse mechanism the graphic will be clipped to the bounding box.

```
setbounds currentpicture to
  unitsquare xyscaled (width,height) ;
```

In the following sections we will demonstrate how you can put graphics behind these 25 areas, as well as behind the (left and right) page.

6.2 Setting up backgrounds

One way of protecting a document for unwanted usage is to put an annoying word in the background. If you like this, you may try the following. The macro `ysized` is part of the macros that come with `CONTEXT` and scales a picture to a specific size.

```
\startuniqueMPgraphic{concept}
  draw btex \colored[s=.8]{\bf CONCEPT} etex rotated 60 ;
  currentpicture := currentpicture
```

¹¹ This is true only in a regular `METAPOST` run. In `CONTEXT MKIV` we follow a different route.

```

    ysize (\overlayheight-.5cm) ;
\stopuniqueMPgraphic

\defineoverlay[concept][\uniqueMPgraphic{concept}]

```

You can now put this graphic in the page background by saying:

```
\setupbackgrounds[page][background=concept]
```

You may consider the next alternative a bit better, but still it renders the text unreadable. Like `xsized`, the macro `enlarged` is not part of standard METAPOST, but comes with `CONTEXT`.

```

\startuniqueMPgraphic{copyright}
  picture p ; p := btex \colored[s=.8]{COPYRIGHT} etex
    rotated 90 ;
  setbounds p to boundingbox p enlarged 1pt ;
  draw p ;
  currentpicture := currentpicture
    xysized (\overlaywidth,\overlayheight) ;
\stopuniqueMPgraphic

\defineoverlay[copyright][\uniqueMPgraphic{copyright}]

```

Again, we put this graphic in the background. By using a unique graphic, we make sure that it's rendered only once and reused when possible.

```
\setupbackgrounds[text][rightmargin][background=copyright]
```

In both cases, we slightly scale down the graphic. We do so because otherwise a small portion of the text is clipped off. This is unrelated to `TEX` or `METAPOST`, but a characteristic of the font. Compare the following Pagella, Latin Modern and Termes `gi`'s (the Pagella is the body font of this text).

```

\hbox \bgroup
  \hbox{\definedfont[file:texgyrepagella-regular at 6cm]gi}%
  \hbox{\definedfont[file:lmroman10-regular at 6cm]gi}%
  \hbox{\definedfont[file:texgyretermes-regular at 6cm]gi}%
\egroup

```

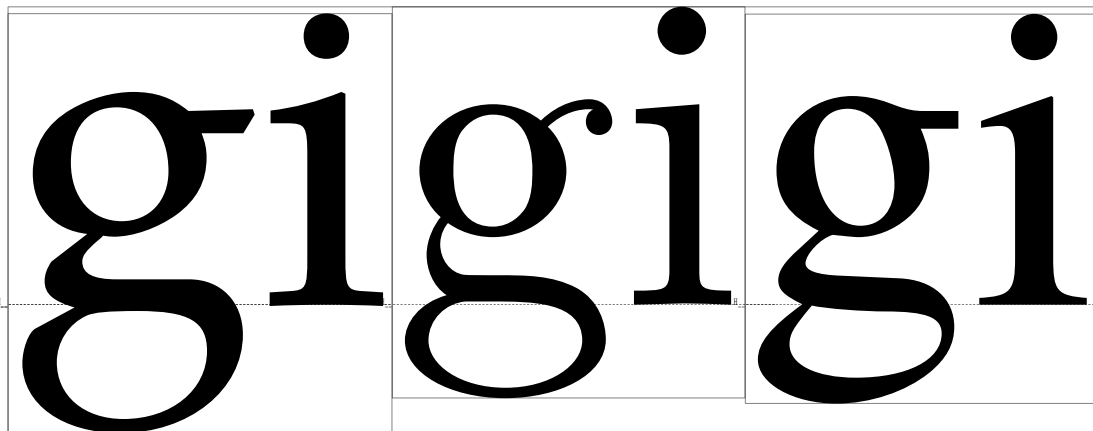

Watch how the bounding boxes differ and sometimes cross the shape. So, in order not to lose part of a glyph when clipping, you need to add a bit of space. Figure 6.1 shows the two backgrounds in action.

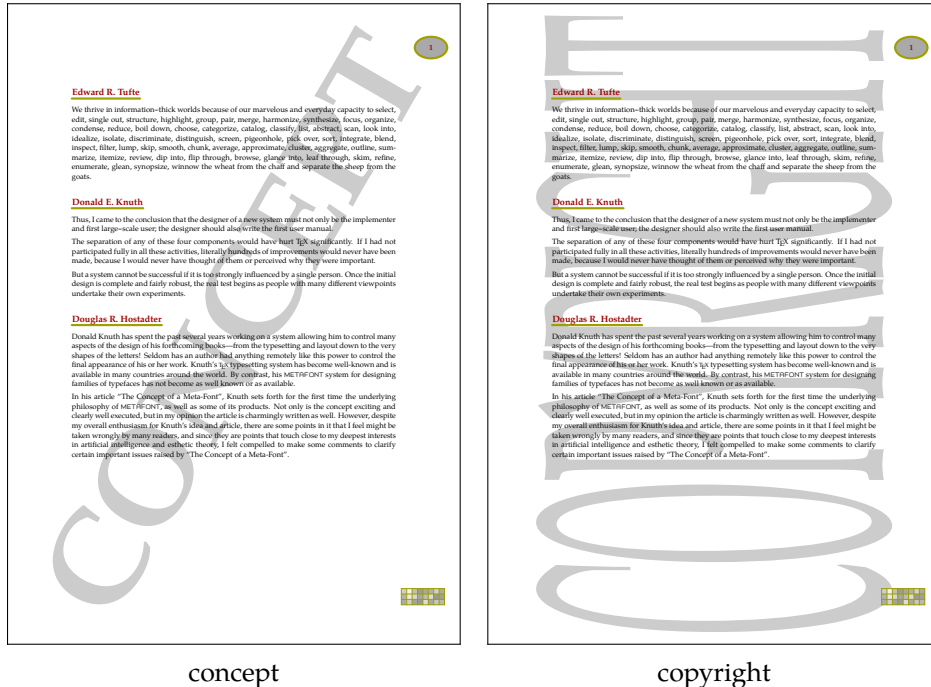

Figure 6.1 Two examples of annoying backgrounds.

If you really want to add such texts to a document, in `CONTEXT` we don't have to use the page background, but can use one of the layout areas instead (like `[text] [text]` or `[text] [leftmargin]`)

```
\setupframedtexts
[FunnyText]
[backgroundcolor=lightgray,
framecolor=darkred,
rulethickness=2pt,
offset=\bodyfontsize,
before={\blank[big,medium]},
after={\blank[big]},
width=\textwidth]
```

There is one drawback: when your left and right margin have different dimensions, the text will be scaled differently on odd and even pages. Normally this is no problem for a draft.

As an alternative you can use the `\setuptexts` command and wrap the graphic in a box with the right dimensions, using code like:

```
\startuniqueMPgraphic{copyright}
picture p ; p := btex COPYRIGHT etex rotated 90 ;
setbounds p to boundingbox p enlarged 1pt ;
draw p withcolor .8white ;
xyscale_currentpicture(\the\leftmarginwidth,\the\textheight) ;
\stopuniqueMPgraphic
```

```
\setuptexttexts [margin] [] [\uniqueMPgraphic{copyright}]
```

The graphic goes into the outer margin. The second argument can be used to put something in the inner margin.

6.3 Multiple overlays

You can stack overlays. Consider the next case, where we assume that you have enabled interaction support using `\setupinteraction[state=start]`:

```
\setupbackgrounds
  [page]
  [background={color,nextpage},
  backgroundcolor=darkyellow]
```

Here, the page gets a colored background and a hyperlink to the next page, previously defined by:

```
\defineoverlay[nextpage] [\overlaybutton{nextpage}]
```

An `\overlaybutton` is just a button, with all attributes (color, frame, etc) set to nothing, having the dimensions of the overlay. The argument is one of the permitted destinations, like `nextpage`, `firstpage`, `SearchDocument` and alike.

For efficiency reasons, the background areas (like `[text] [text]`) are calculated only when their definition has changed. When a background changes per page, we have to recalculate it on each page. In the next example, the macro `\overlaybutton` generates a different button on each page. But, since we don't explicitly set the background at each page, there is no way the background drawing mechanism can know that this button has changed. Therefore, we must force recalculation with:

```
\setupbackgrounds [state=repeat]
```

You can test this concept yourself with the following code. Here we assume that you have a file called `tufte.tex` on your system, which is the case if you have `CONTEXT` installed. However, you can just as easily use any file having a paragraph of two of text.

```
\starttext
\setupinteraction[state=start]
\setupbackgrounds[state=repeat]
\defineoverlay[nextpage] [\overlaybutton{nextpage}]
\setupbackgrounds[text] [text] [background=nextpage]
\dorecurse{20}{\input tufte \par}
\stoptext
```

Note that you can move forward from page to page in the resulting PDF file by clicking on each page with the mouse. Now compile this file without setting the background state to repeat and note the difference as you click pages with the mouse.

Setting the state was not needed when we used the page background:

```
\setupbackgrounds [page] [background=nextpage]
```

The `\dorecurse` macro is handy for testing since it saves us typing. One can nest this macro as in:

```
\dorecurse{20}{\dorecurse{10}{Hello World! }}\par}
```

The current step is available in `\recurselevel` and the depth (nesting level) in `\recursedepth`.

6.4 Crossing borders

In many cases, the previously mentioned background areas will suffice, but in the case of more complicated backgrounds, you may wish to use METAPOST to draw graphics that combine or span these areas.

At runtime `CONTEXT` saves information on the layout that can be picked up by METAPOST. The framework for a page graphic is:

```
StartPage;
  % all kind of commands
StopPage ;
```

Between the `StartPage` and `StopPage` command you have access to a wide range of variables:

page	PaperHeight PaperWidth PrintPaperHeight PrintPaperWidth PageOffset PageDepth
margins	TopSpace BackSpace
text	MakeupHeight MakeupWidth
vertical	TopHeight TopDistance HeaderHeight HeaderDistance TextHeight FooterDistance FooterHeight BottomDistance BottomHeight
horizontal	LeftEdgeWidth LeftEdgeDistance LeftMarginWidth LeftMarginDistance TextWidth RightMarginDistance RightMarginWidth RightEdgeDistance RightEdgeWidth

Since using these variables to construct paths is not that handy because the areas are available as predefined paths, which we will demonstrate here.

In figure 6.2 you see two pages (odd and even) with a background spanning the outer margin and the text area. You can access an area in two ways. The area itself is available as `Area`.

```
StartPage ;
  fill Area[Text][Text] withcolor .85white ;
StopPage ;
```

If you use an area this way, you will notice that it is not positioned at the right place. An `Area` is just a rectangle. If you want a positioned area, you should use the `Field` array:

```
StartPage ;
  fill Field[Text][Text] withcolor .85white ;
StopPage ;
```

The location of an area is available in `Location`, so the previous definition is the same as:

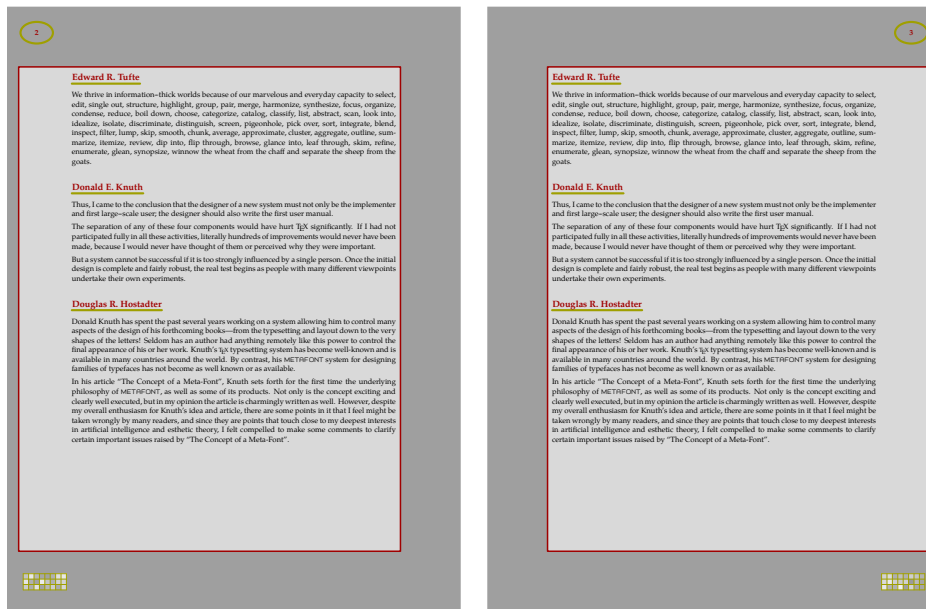

even

odd

Figure 6.2 A background with combined areas.

```
StartPage ;
fill Area[Text][Text] shifted Location[Text][Text]
withcolor .85white ;
StopPage ;
```

The following definition fills and draws the margin and text areas.

```
\startuseMPgraphic{page}
StartPage ;
pickup pencircle scaled 2pt ;
fill Page withcolor .625white ;
fill Field[OuterMargin][Text] withcolor .850white ;
fill Field[Text][Text] withcolor .850white ;
draw Field[OuterMargin][Text] withcolor .625red ;
draw Field[Text][Text] withcolor .625red ;
StopPage ;
\stopuseMPgraphic
```

This background is assigned to the page layer by saying:

```
\defineoverlay[page][\useMPgraphic{page}]
\setupbackgrounds[page][background=page]
```

As you can see in figure 6.3, the text is typeset rather tightly between the left and right margins.

This can easily be solved by enlarging the areas a bit. The next example demonstrates this on the text area, which is shown in figure 6.4.

```
\startuseMPgraphic{page}
```

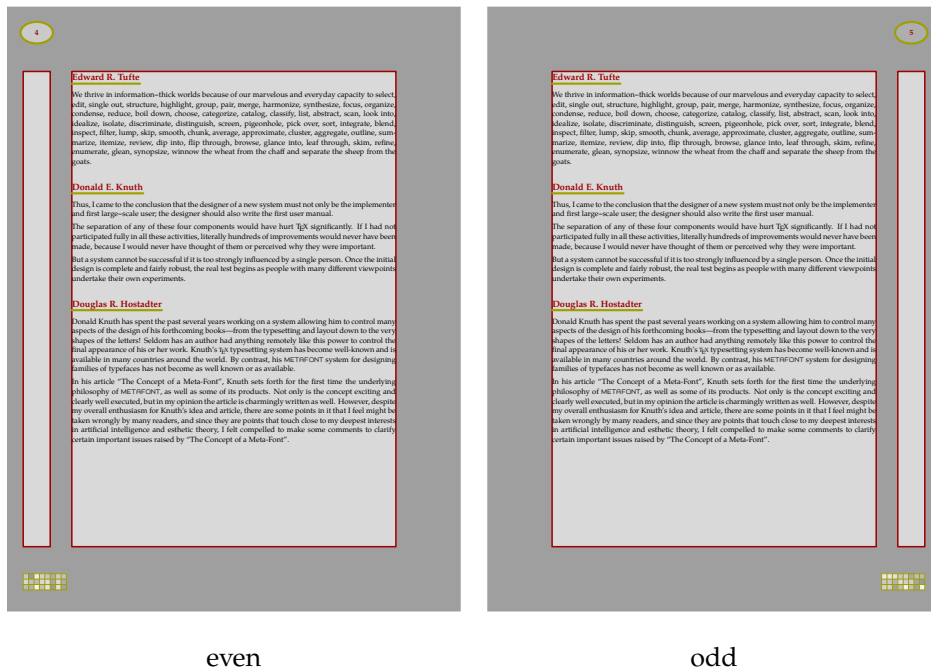

Figure 6.3 A background with split areas.

```

StartPage ;
pickup pencircle scaled 2pt ;
fill Page withcolor .625white ;
fill Field[Text][Text] enlarged .5cm withcolor .850white ;
draw Field[Text][Text] enlarged .5cm withcolor .625red ;
StopPage ;
\stopuseMPgraphic

```

The enlarged macro can be used like shifted and accepts either a numeric or a pair.

How do we define a background as in figure 6.2? Because Field provides us the positioned areas, we can use the corners of those.

```

\startuseMPgraphic{page}
StartPage ;
path Main ;
if OnRightPage :
  Main := lrcorner Field[OuterMargin][Text] --
         llcorner Field[Text][Text] --
         ulcorner Field[Text][Text] --
         urcorner Field[OuterMargin][Text] -- cycle ;
else :
  Main := llcorner Field[OuterMargin][Text] --
         lrcorner Field[Text][Text] --
         urcorner Field[Text][Text] --
         ulcorner Field[OuterMargin][Text] -- cycle ;
fi ;
Main := Main enlarged 6pt ;

```

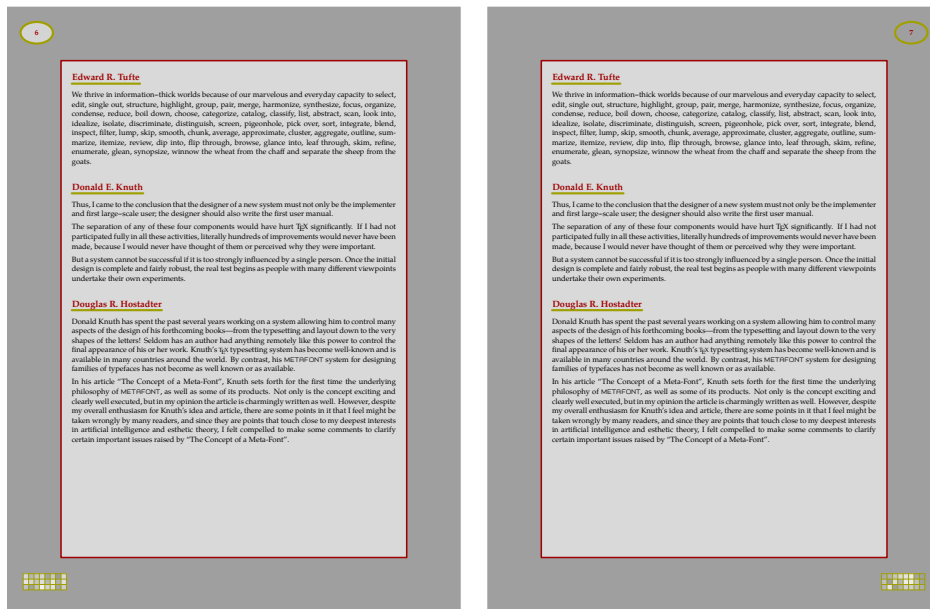

even

odd

Figure 6.4 A background with enlarged text area.

```

pickup pencircle scaled 2pt ;
fill Page withcolor .625white ;
fill Main withcolor .850white ;
draw Main withcolor .625red ;
StopPage ;
\stopuseMPgraphic

```

In this definition we calculate a different path for odd and even pages. When done, we enlarge the path a bit. If you want to use different offsets in all directions, you can use moved corner points.

```

\startuseMPgraphic{page}
  StartPage ;
  def somewhere =
    (uniformdeviate 1cm,uniformdeviate 1cm)
  enddef ;
  path Main ;
  Main := Field[Text][Text] lrmoved somewhere --
    Field[Text][Text] llmoved somewhere --
    Field[Text][Text] ulmoved somewhere --
    Field[Text][Text] urmoved somewhere -- cycle ;
  pickup pencircle scaled 2pt ;
  fill Page withcolor .625white ;
  fill Main withcolor .850white ;
  draw Main withcolor .625red ;
  StopPage ;
\stopuseMPgraphic

```

Here we displace the corners randomly which leads to backgrounds like figure 6.5. The following definition would have worked as well:

```
\startuseMPgraphic{page}
  StartPage ;
  path Main ; Main := Field[Text][Text] randomized 1cm ;
  pickup pencircle scaled 2pt ;
  fill Page withcolor .625white ;
  fill Main withcolor .850white ;
  draw Main withcolor .625red ;
  StopPage ;
\stopuseMPgraphic
```

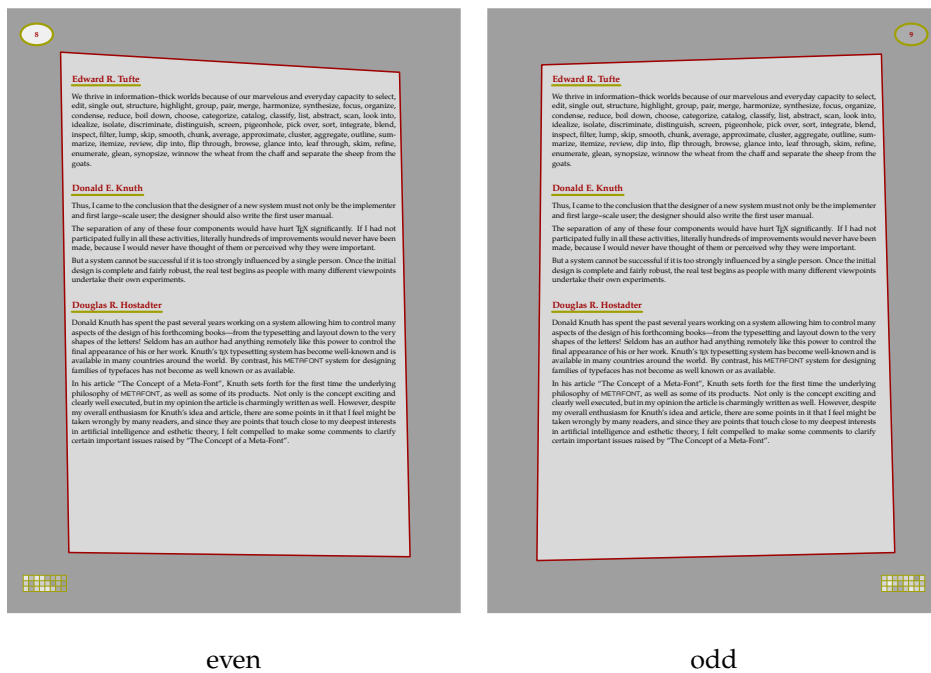

Figure 6.5 A random text area.

The previous graphics are defined as usable ones, which means that they will be recalculated each page. This is rather inefficient when the shapes don't change. But, using a reusable graphic instead, would result in only one graphic for both pages. Since the layout for the left and right page differs, another method is needed.

Instead of putting the same graphic on the page layer, we put two different ones on the left and right page layer.

```
\defineoverlay[left page] [\useMPgraphic{left page}]
\defineoverlay[right page] [\useMPgraphic{right page}]

\setupbackgrounds[leftpage] [background=left page]
\setupbackgrounds[rightpage] [background=right page]
```

Now we only have to split the previously defined graphic into two parts. In order to force consistency, we isolate the code that fills and draws. The left page code looks like:

```

\startreusableMPgraphic{left page}
  StartPage ;
  path Main ; Main :=
    llcorner Field[OuterMargin] [Text] --
    lrcorner Field[Text] [Text] --
    urcorner Field[Text] [Text] --
    ulcorner Field[OuterMargin] [Text] -- cycle ;
  \includeMPgraphic{draw page}
  StopPage ;
\stopreusableMPgraphic

```

The right page text looks similar:

```

\startreusableMPgraphic{right page}
  StartPage ;
  path Main ; Main :=
    lrcorner Field[OuterMargin] [Text] --
    llcorner Field[Text] [Text] --
    ulcorner Field[Text] [Text] --
    urcorner Field[OuterMargin] [Text] -- cycle ;
  \includeMPgraphic{draw page}
  StopPage ;
\stopreusableMPgraphic

```

Watch how we used a reusable graphic first and a simple usable one next. Actually, the next graphic is not a stand alone graphic.

```

\startuseMPgraphic{draw page}
  Main := Main enlarged 6pt ;
  pickup pencircle scaled 2pt ;
  fill Page withcolor .625white ;
  fill Main withcolor .850white ;
  draw Main withcolor .625red ;
\stopuseMPgraphic

```

We have seen some predefined paths and locations. Apart from the Page path, they take two arguments that specify their position on the layout grid.

path Area [] []	an area similar to a CONTEXT one
pair Location [] []	the position of this area
path Field [] []	the area positioned at the right place
path Page	the page itself

Some less used and more obscure variables are the following.

numeric Hstep []	the horizontal distance to the previous area
numeric Vstep []	the vertical distance to the previous area
numeric Hsize []	the width of an area
numeric Vsize []	the height of an area

The array variables are accessed by using constants:

horizontal	vertical
LeftEdge	Top
LeftEdgeSeparator	TopSeparator
LeftMargin	Header
LeftMarginSeparator	HeaderSeparator
Text	Text
RightMarginSeparator	FooterSeparator
RightMargin	Footer
RightEdgeSeparator	BottomSeparator
RightEdge	Bottom

In addition to these, there are `Margin`, `InnerMargin` and `OuterMargin` which adapt themselves to the current odd or even page. The same is true for `Edge`, `InnerEdge` and `OuterEdge`, although these will seldom be used, since interactive documents are always single sided.

We started this chapter with spending a lot of code to simulate the page areas. It will be clear now that in practice this is much easier using the mechanism described here.

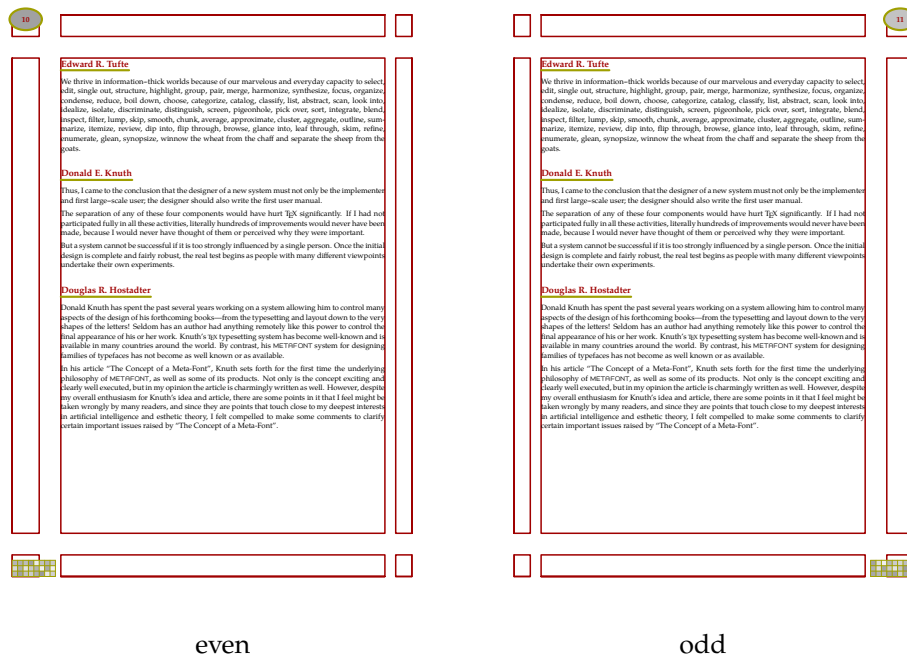

Figure 6.6 A quick way to draw all used areas.

In figure 6.6 we see all used areas. Areas that are not used are not drawn (which saves some testing). This background was defined as:

```
\startuseMPgraphic{page}
  StartPage
  for i=Top,Header,Text,Footer,Bottom :
    for j=LeftEdge,LeftMargin,Text,RightMargin,RightEdge :
      draw Field[i][j] withpen pencircle scaled 2pt withcolor .625red ;
    endfor ;
endfor ;
```

```

        endfor ;
    StopPage
\stopuseMPgraphic

```

We use two nested for loops to step over the areas. A for loop with a step of 1 will fail, because the indices are defined in a rather special way. On the other hand, the mechanism is rather tolerant, in the sense that [i] [j] and [j] [i] are both accepted.

6.5 Bleeding

If you want to share your document all over the world, it makes sense to use a paper format like *letter* or *A4*. In that case, the layout often matches the paper size.

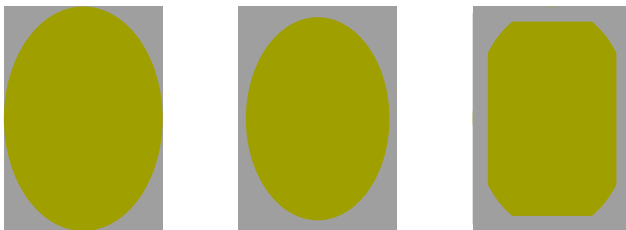

The left picture demonstrates what happens when you have a printer that is capable of printing from edge to edge. If you have such a printer, you're lucky. The middle picture demonstrates what happens if you have a properly set up printing program and/or printer: the page is scaled down so that the content fits into the non printable area of the printer. One reason why printers don't print from edge to edge is that the engine is not that happy when toner or ink ends up next to the page. The third picture shows what happens when a printer simply ignores content that runs over the non printable area. In many cases it's best to make sure that the content leaves a margin of 5mm from the edges.

Books and magazines seldom use the popular desk-top paper sizes. Here the designer determined the paper size and layout more or less independent from the size of the sheet on which the result is printed. Instead of one page per sheet, arrangements of 2 upto 32 or more pages per sheet are made. The process of arranging pages in such a way that these sheets can be folded and combined into books is called page imposition. `CONTEXT` supports a wide range of page imposition schemes. More information on this can be found in the `CONTEXT` manuals.

The fact that the sheet on which a page is printed is larger than the page itself opens the possibility to use the full page for content. In that case, especially when you use background graphics, you need to make sure that indeed the page is covered completely. Where in desk top printing you can get away with imperfection simply because the printing engines have their limitations, in professional output you need to be more considerate.

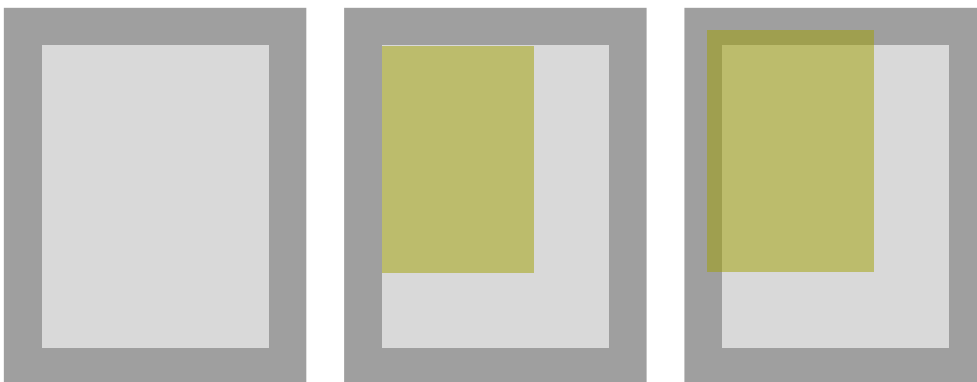

Slightly enlarging a graphic so that it exceeds the natural page limits is called bleeding. Because quite often layout elements have a rectangular nature, METAFUN provides a couple of operations that can save you some work in defining bleeding boxes.

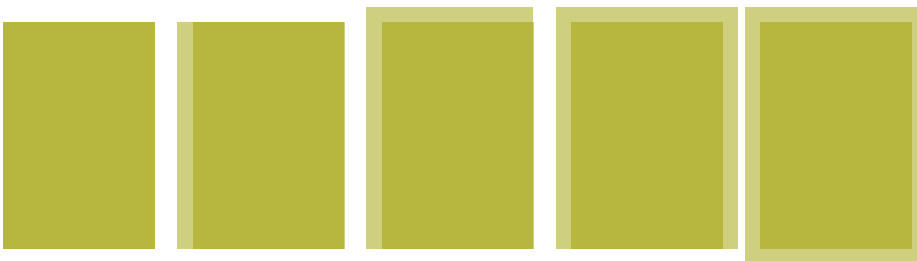

This graphic is generated as follows:

```

path p, q ;
def ShowPath =
  fill p withcolor transparent(1,.5,.625yellow) ;
  fill q withcolor transparent(1,.5,.625yellow) ;
  currentpicture := currentpicture shifted (-25mm,0) ;
enddef ;
p := q := fullsquare xyscaled (2cm,3cm) ; ShowPath ;
p := p leftenlarged 2mm ; ShowPath ;
p := p topenlarged 2mm ; ShowPath ;
p := p rightenlarged 2mm ; ShowPath ;
p := p bottomenlarged 2mm ; ShowPath ;

```

The trick is in the last couple of lines. In addition to the general enlarged operator, we have 4 operators that enlarge a rectangle in a certain direction. This means that we can define the original path using dimensions related to the layout, and add bleed strips independently.

```

path p ; p := fullsquare xyscaled (4cm,1cm) ;
path q ; q := p leftenlarged 2mm topenlarged 2mm ;
fill p withcolor transparent(1,.5,.625yellow) ;
fill q withcolor transparent(1,.5,.625yellow) ;
draw boundingbox currentpicture withcolor .625red ;

```



This example demonstrates that when we enlarge a graphic, the bounding box also gets larger. Because this can interfere with the placement of such a graphic, we need to make sure that the bleeding is there but not seen.

```
path p ; p := fullsquare xyscaled (4cm,1cm) ;
path q ; q := p leftenlarged 2mm topenlarged 2mm ;
fill p withcolor transparent(1,.5,.625yellow) ;
fill q withcolor transparent(1,.5,.625yellow) ;
setbounds currentpicture to p ;
draw boundingbox currentpicture withcolor .625red ;
```



There are two more operators: `innerenlarged` and `outerenlarged`. These expand to either `leftenlarged` or `rightenlarged`, depending on the page being left or right hand.

7 Shapes, symbols and buttons

One can use METAPOST to define symbols and enhance buttons. Here we introduce some of the gadgets that come with CONTEXT, as well as explain how to integrate such gadgets yourself.

7.1 Interfacing to T_EX

In the early days of METAPOST support in CONTEXT, Tobias Burnus asked me if it was possible to define English rules. What exactly does an english rule look like? Here is one:

As you can see, such a rule has to adapt itself to the current text width, normally `\hsize` in T_EX, or on request `\availablehsize` in CONTEXT. We need to set the height to a reasonable size, related to the font size, and we also need to take care of proper spacing. Of course we want to run METAPOST as less times as possible, so we need to use unique graphics. Let's start with the graphic.

```
\setupMPvariables
  [EnglishRule]
  [height=1ex,
   width=\availablehsize,
   color=darkgray]

\startuniqueMPgraphic{EnglishRule}{height,width,color}
  numeric height ; height = \MPvar{height} ;
  x1 = 0 ; x3 = \MPvar{width} ; x2 = x4 = .5x3 ;
  y1 = y3 = 0 ; y2 := -y4 = height/2 ;
  fill z1 .. z2 .. z3 & z3 .. z4 .. z1 & cycle
    withcolor \MPvar{color} ;
\stopuniqueMPgraphic
```

As you can see, we pass two arguments to the graphic definition. The first argument is the name, the second argument is a comma separated list of variables. This list serves two purposes. First this list is used to create a unique profile for the graphic. This means that when we change the value of a variable, a new graphic is generated that reflects the change. A second purpose of the list is to convert T_EX data structures into METAPOST ones, especially dimensions and colors. The graphic itself is not that spectacular. We use `&` because we don't want smooth connections.

```
\defineblank
  [EnglishRule]
  [medium]

\unexpanded\def\EnglishRule
  {\start
   \dontcomplain
   \startlinecorrection[EnglishRule]
   \noindent \reuseMPgraphic{EnglishRule}
   \stoplinecorrection
   \stop}
```

When setting the variables, we used `\availablehsize`. We need to use `\noindent`, a rather familiar T_EX primitive, that we use here to start a non indented paragraph, being the graphic. The

line correction is needed to get the spacing around the rule (graphic) right. We pass a blank skip identifier that is mapped to a convenient medium skip.

```

Why is this called an English line?

\startnarrower
\EnglishRule
  Is it because they cannot draw a straight one? This could be true
  after a few strong beers, but then, how do Germans draw a line?
\EnglishRule
\stopnarrower

```

As expected, the rule adapts itself to the current width of the text. The height of the rule in the middle matches the height of a character with no ascenders and descenders.

Why is this called an English line?

```

Is it because they cannot draw a straight one? This could be true after a few strong beers,
but then, how do Germans draw a line?

```

7.2 Random graphics

Given enough time and paper, we can probably give you some

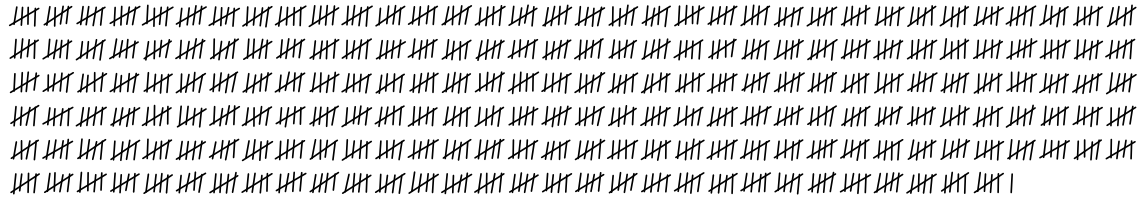

reasons why METAPOST is fun. To mention a few: you can enhance the layout with graphic ornaments, you can tune your graphics at runtime, and simple high quality graphics can be very effective.

The previous graphics draws exactly 1001 lines in a scratch-numbers-in-a-wall fashion. In 1998, the NTG did a survey among its members, and in the report, we used this fuzzy counter to enhance the rather dull tables.

system	%	# users
Atari	10.4	
MSDOS	49.1	
OS/2	9.4	
MacOS	5.7	
UNIX	51.9	
WINDOWS	64.2	

Table 7.1 Operating system (n=106).

Table 7.1 demonstrates how scratch numbers can be used. An interesting side effect is that when you look long enough to these kind of graphics, it looks like the lines are no longer horizontal. This table is defined as follows:

```

\starttabulate[|l|c|l|]
\HL
\NC system \NC \% \NC \# users \NC\NR
\HL
\NC Atari \NC 10.4 \NC \useMPgraphic{fuzzycount}{n=11} \NC\NR
\NC MSDOS \NC 49.1 \NC \useMPgraphic{fuzzycount}{n=52} \NC\NR
\NC OS/2 \NC ~9.4 \NC \useMPgraphic{fuzzycount}{n=10} \NC\NR
\NC MacOS \NC ~5.7 \NC \useMPgraphic{fuzzycount}{n= 6} \NC\NR
\NC UNIX \NC 51.9 \NC \useMPgraphic{fuzzycount}{n=55} \NC\NR
\NC WINDOWS \NC 64.2 \NC \useMPgraphic{fuzzycount}{n=68} \NC\NR
\HL
\stoptabulate

```

You will notice that we pass a variable to the graphic using a second argument. We can access this variable with `\MPvar`. The graphic is defined as usable graphic, because we want to generate a unique random one each time.

```

\startuseMPgraphic{fuzzycount}
  begingroup
  save height, span, drift, d, cp ;
  height := 3/ 5 * \baselinedistance ;
  span := 1/ 3 * height ;
  drift := 1/10 * height ;
  pickup pencircle scaled (1/12 * height) ;
  def d = (uniformdeviate drift) enddef ;
  for i := 1 upto \MPvar{n} :
    draw
      if (i mod 5)=0 : ((-d-4.5span,d)--(+d-0.5span,height-d))
      else : ((-d,+d)--(+d,height-d)) fi
      shifted (span*i,d-drift) ;
  endfor;
  picture cp ; cp := currentpicture ; % for readability
  setbounds currentpicture to
    (llcorner cp shifted (0,-ypart llcorner cp) --
     lrcorner cp shifted (0,-ypart lrcorner cp) --
     urcorner cp -- ulcorner cp -- cycle) ;
  endgroup ;
\stopuseMPgraphic

```

The core of the macro is the for loop. Within this loop, we draw groups of four plus one lines. The draw path's look a bit complicated, but this has to do with the fact that a mod returns 0 – 4 while we like to deal with 1 – 5.

The height adapts itself to the height of the line. The bounding box correction at the end ensures that the baseline is consistent and that the random vertical offsets fall below the baseline.

Because we want to be sure that n has a value, we preset it by saying:

```
\setupMPvariables[fuzzycount][n=10]
```

In the table, it makes sense to adapt the drawing to the lineheight, but a more general solution is to adapt the height to the fontsize.

```
height := 3/ 4 * \the \bodyfontsize * \currentfontscale ;
```

In the table we called the graphic directly, but how about making it available as a conversion macro? In `CONTEXT` this is not that hard:

```
\def\fuzzycount#1{\tx\useMPgraphic{fuzzycount}{n=#1}}
\defineconversion[fuzzy][\fuzzycount]
```

Because such a counter should not be that large, we use `\tx` to switch to a smaller font. This also demonstrates how the graphic adapts itself to the font size.

We can now use this conversion for instance in an itemize. To save space we use three columns and no white space between the lines. The `2*broad` directive makes sure that we have enough room for the number.

```
l.   one                |||.   four                |||.  ll. seven
ll.  two                |||.  five                |||.  |||. eight
|||. three             |||.  l.  six                |||.  |||.nine
```

```
\startitemize[fuzzy,pack,2*broad,columns,three]
\item one   \item two   \item three
\item four  \item five  \item six
\item seven \item eight \item nine
\stopitemize
```

A careful reader will have noticed that the previous definition of the fuzzy counter drawing is not suited to generate the graphics we started with.

```
\useMPgraphic{fuzzycount}{n=1001}
```

This time we want to limit the width to the current `\hsize`. We only need to add a few lines of code. Watch how we don't recalculate the bounding box when more lines are used.

```
\startuseMPgraphic{fuzzycount}
  begingroup
  save height, vstep, hsize, span, drift, d, cp ;
  height := 3/ 4 * \the \bodyfontsize * \currentfontscale ;
  span   := 1/ 3 * height ;
  drift  := 1/10 * height ;
  hsize  := \the\hsize ;
  vstep  := \the\lineheight ;
  xmax   := hsize div 5span ;
  pickup pencircle scaled (1/12 * height) ;
  def d = (uniformdeviate drift) enddef ;
  for i := 1 upto \MPvar{n} :
    xpos := ((i-1) mod (5*xmax))*span ;
    ypos := ((i-1) div (5*xmax))*vstep ;
    draw
      if (i mod 5)=0 : ((-d-4.5span,d)--(+d-0.5span,height-d))
      else           : ((-d,+d)--(+d,height-d)) fi
    shifted (xpos,-ypos+d-drift) ;
```



```

endfor;
picture cp ; cp := currentpicture ;
if (ypart ulcorner cp - ypart llcorner cp) <= vstep :
  setbounds currentpicture to
    (llcorner cp shifted (0,-ypart llcorner cp) --
     lrcorner cp shifted (0,-ypart lrcorner cp) --
     urcorner cp -- ulcorner cp -- cycle) ;
fi
endgroup ;
\stopuseMPgraphic

```

7.3 Graphic variables

In the previous sections we have seen that we can pass information to the graphic by means of variables. How exactly does this mechanism work?

A nice application of setting up variables for a specific graphic (or class of graphics) is the following. In an email message the author can express his own or the readers expected emotions with so called smilies like: ☺. If you want them in print, you can revert to combinations of characters in a font, but as a \TeX user you may want to include nicer graphics.

A convenient way to implement these is to make them into symbols, one reason being that in that case they will adapt themselves to the current font size.

```

Say it with a \symbol [smile]\ or maybe even a \symbol
[smilemore], although seeing too many \dorecurse {10}
{\symbol [smile]\ } \unskip in one text may make you cry.

```

Say it with a ☺ or maybe even a ☺, although seeing too many ☺☺☺☺☺☺☺☺☺ in one text may make you cry.

Because we want an efficient implementation, we will use unique graphics, because these will only be generated when the circumstances change.

```

\definesymbol [smile] [\uniqueMPgraphic{smile}{type=1}]
\definesymbol [smilemore] [\uniqueMPgraphic{smile}{type=2}]

```

The definition itself then becomes:

```

\setupMPvariables [smile] [type=1,height=1.25ex,color=darkred]
\startuniqueMPgraphic{smile}{type,height,color}
  numeric size ; size := \MPvar{height} ;
  drawoptions(withcolor \MPvar{color}) ;
  pickup pencircle xscaled (size/6) yscaled (size/12) ;
  draw halfcircle rotated -90 scaled size ;
  pickup pencircle scaled (size/4) ;
  if \MPvar{type}=1 :
    for i=-1,+1 : draw origin shifted (0,i*size/4) ; endfor ;
  elseif \MPvar{type}=2 :
    for i=-1,+1 : draw origin shifted (-size/2,i*size/4) ; endfor ;
    pickup pencircle scaled (size/6) ;
    draw (size/4,0) -- (-size/4,0) ;

```

```
fi ;
\stopuniqueMPgraphic
```

We can now change some characteristics of the smilies without the need to redefine the graphic.

```
\setupMPvariables[smile][height=1ex,color=darkred]
```

Say it with a ☺ or maybe even a ☺, although seeing too many ☺☺☺☺☺☺☺☺☺☺ in one text may make you cry.

In order to keep the smilies unique there is some magic involved, watch the second argument in the next line:

```
\startuniqueMPgraphic{smile}{type,height,color}
```

Because unique graphics often are used in backgrounds, its uniqueness is determined by the overlay characteristics. In our case however the uniqueness is determined by the smilies type, height and color. By explicitly specifying these, we make sure that they count in the creation of the uniqueness stamp.

```
\midaligned{\switchtobodyfont[60pt]\symbol[smile]}
```

Because we use the ex-height, the previous call works as expected.



7.4 Shape libraries

Unfortunately it takes some effort to define graphics, attach them to an overlay, and invoke the background. However, the good news is that since in many cases we want a consistent layout, we only have to do it once. The next table has some hashed backgrounds. (More information about how to define tables can be found in the `CONTEXT` documentation and `Up-To-Date` documents.)

right	left	horizontal	vertical
-------	------	------------	----------

Table 7.2 A hashed table.

This table is defined as:

```
\bTABLE[frame=off,meta:hash:linecolor=darkyellow,offset=3ex]
\bTR
\bTD[background=meta:hash:right] right \eTD
\bTD[background=meta:hash:left] left \eTD
\bTD[background=meta:hash:horizontal] horizontal \eTD
\bTD[background=meta:hash:vertical] vertical \eTD
\eTR
\eTABLE
```

The graphics themselves are defined in a `METAPOST` module. In this particular example, the macro `some_hash` is defined in the file `mp-back.mp`. This macro takes six arguments:

```
some_hash (width, height, linewidth, linecolor, angle, gap) ;
```

Because we don't want to define a specific overlay for each color and linewidth, we will use variables in the definition of the unique graphic.

```
\startuniqueMPgraphic{meta:hash}{linewidth,linecolor,angle,gap}
  if unknown context_back : input mp-back ; fi ;
  some_hash ( OverlayWidth, OverlayHeight ,
            \MPvar{linewidth}, \MPvar{linecolor} ,
            \MPvar{angle}, \MPvar{gap} ) ;
\stopuniqueMPgraphic
```

These variables are preset using `\setupMPvariables`:

```
\setupMPvariables
[meta:hash]
[gap=.25\bodyfontsize,
angle=45,
linewidth=\overlaylinewidth,
linecolor=\overlaylinecolor]
```

The last step in this process is to define the different alternatives as overlays:

```
\def\metahashoverlay#1{\uniqueMPgraphic{meta:hash}{angle=#1}}
\defineoverlay[meta:hash:right] [\metahashoverlay{ +45}]
\defineoverlay[meta:hash:left] [\metahashoverlay{ -45}]
\defineoverlay[meta:hash:horizontal] [\metahashoverlay{+180}]
\defineoverlay[meta:hash:vertical] [\metahashoverlay{ -90}]
```

As we can see in the definition of the table, we can pass settings to the `\bTABLE` command. Actually, we can pass such settings to each command that supports backgrounds, or more precisely `\framed`. Table 7.3 is for instance defined as:

```
\bTABLE[frame=off,meta:hash:linewidth=.4pt,align=middle,offset=2ex]
\bTR
  \bTD[background={meta:hash:left,meta:hash:right},
      meta:hash:linecolor=darkyellow]
    left \par \& \par right \eTD
  \bTD[background={meta:hash:horizontal,meta:hash:vertical},
      meta:hash:linecolor=darkred]
    horizontal \par \& \par vertical \eTD
\eTR
\eTABLE
```

The long names are somewhat cumbersome, but in that way we can prevent name clashes. Also, since the METAPOST interface is english, the variables are also english.

7.5 Symbol collections

In `CONTEXT`, a symbol can be defined without much coding. The advantage of using symbols is that you can redefine them depending on the situation. So,

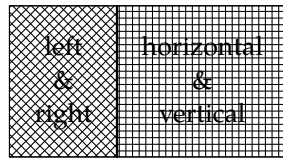

Table 7.3 A double hashed table.

```
\definesymbol [yes] [\em Yes!]
```

creates a symbol, that lets `\symbol[yes]` expand into *Yes!* Since nearly anything can be a symbol, we can also say:

```
\definesymbol [yes] [\mathematics{\star}]
```

or even the already defined symbol `*`, by saying:

```
\definesymbol [yes] [{\symbol[star]}]
```

It may be clear that we can use a graphic as well:

```
\def\metabuttonsymbol#1{\uniqueMPgraphic{meta:button}{type=#1}}

\definesymbol [menu:left] [\metabuttonsymbol{101}]
\definesymbol [menu:right] [\metabuttonsymbol{102}]
\definesymbol [menu:list] [\metabuttonsymbol{103}]
\definesymbol [menu:index] [\metabuttonsymbol{104}]
\definesymbol [menu:person] [\metabuttonsymbol{105}]
\definesymbol [menu:stop] [\metabuttonsymbol{106}]
\definesymbol [menu:info] [\metabuttonsymbol{107}]
\definesymbol [menu:down] [\metabuttonsymbol{108}]
\definesymbol [menu:up] [\metabuttonsymbol{109}]
\definesymbol [menu:print] [\metabuttonsymbol{110}]
```

Since we have collected some nice buttons in a METAPOST file already, we can use a rather simple definition:

```
\startuniqueMPgraphic{meta:button}{type,size,linecolor,fillcolor}
  if unknown context_buttn : input mp-buttn ; fi ;
  some_button ( \MPvar{type},
               \MPvar{size},
               \MPvar{linecolor},
               \MPvar{fillcolor} ) ;
\stopuniqueMPgraphic
```

This leaves a few settings:

```
\setupMPvariables
  [meta:button]
  [type=1,
   size=2\bodyfontsize,
   fillcolor=gray,
   linecolor=darkred]
```

These symbols are collected in table 7.4, and are called up with the `CONTEXT` commands like `\symbol[menu:left]`. If needed, we can collect these button symbols in a so called symbol set, which permits us to instantly switch between sets with similar symbols.



Table 7.4 A collection of button symbols.

8 Special effects

Sometimes we want to go beyond METAPOST's native features. Examples of such an extension are CMYK colors, shading and transparency. Although features like this should be used with care, sometimes the documents look and feel can profit from it.

If you don't want the whole graphic, but only a part of it, clipping comes into play. In addition to the standard clipping features, we can use METAPOST to provide a decent clipping path. In this chapter we will uncover the details.

We will also introduce ways to include externally defined graphics and outline fonts. We will demonstrate that within reasonable bounds you can manipulate such graphics.

8.1 Spot colors

You can define spot and multitone colors directly in METAFUN, although normally you will do it at the \TeX end for consistency. At the \TeX end we define this:

```
\definecolor [SpotBlue] [c=1,m=.38,y=0,k=.64]
\definecolor [SpotYellow] [c=0,m=.28,y=1,k=.06]
\definemultitonecolor [MultiColor] [SpotBlue=.5,SpotYellow=.25]
```

Next we process this graphic:

```
draw image (
  fill unitsquare shifted (7,0)
    withcolor namedcolor("MultiColor") ;
  fill unitsquare shifted (6,0)
    withcolor .6 * spotcolor("temp1",red) ;
  fill unitsquare shifted (5,0)
    withcolor .4 * spotcolor("temp1",red) ;
  fill unitsquare shifted (4,0)
    withcolor .5 * spotcolor("temp2",.5green) ;
  fill unitsquare shifted (3,0)
    withcolor .5 * spotcolor("temp3",green) ;
  fill unitsquare shifted (2,0)
    withcolor multitonecolor("temp4",blue/2,yellow/2,green/2,magenta/3) ;
) xsize TextWidth ;
```

and get:

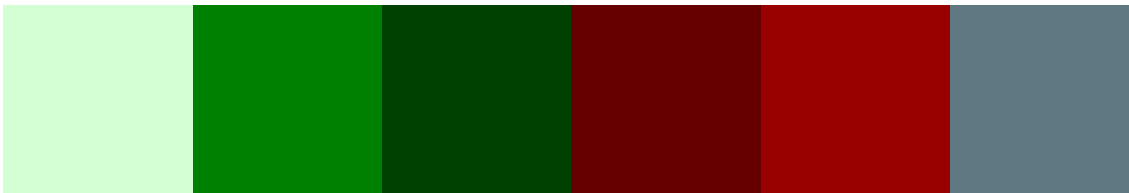

8.2 Transparency

In the screen version we use a light gray background color. As a result, some of the transparency methods demonstrated here give unexpected results. The A4 version of this document demonstrates the real effects.

Although transparent colors have been around for some time already, it was only around 2000 that they made it as a high level feature into document format languages like PDF. Supporting such a feature at a higher abstraction level is not only more portable, but also less sensitive for misinterpretation.

```

vardef ColorCircle (expr method, factor, ca, cb, cc) =
  save u, p ; path p ; p := fullcircle shifted (1/4,0) ;
  image
  ( fill p rotated 90 withcolor ca withtransparency (method,factor) ;
    fill p rotated 210 withcolor cb withtransparency (method,factor) ;
    fill p rotated 330 withcolor cc withtransparency (method,factor) ; )
enddef ;

draw ColorCircle ("normal", .5, red, green, blue) xsized 3cm ;
currentpicture := currentpicture shifted (-4cm,0) ;
draw ColorCircle ("exclusion", .5, red, green, blue) xsized 3cm ;
currentpicture := currentpicture shifted (-4cm,0) ;
draw ColorCircle ("exclusion", 1, red, green, blue) xsized 3cm ;

```

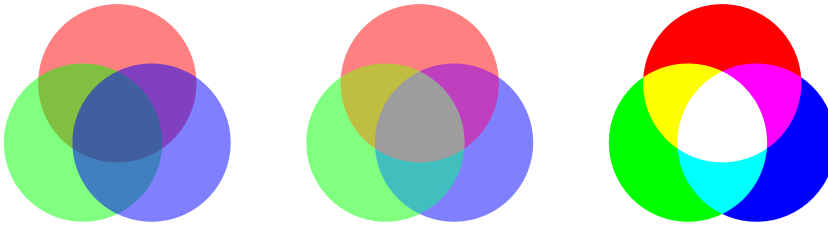

```

cmykcolor xcyan ; xcyan := (1,0,0,0) ;
cmykcolor xmagenta ; xmagenta := (0,1,0,0) ;
cmykcolor xyellow ; xyellow := (0,0,1,0) ;

draw ColorCircle ("exclusion", .5, xcyan, xmagenta, xyellow) xsized 3cm ;

```

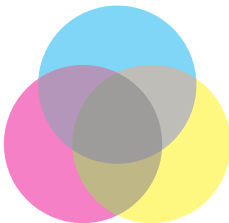

You can be tempted to use transparency as a convenient way to achieve soft colors. In that case you should be aware of the fact that rendering transparent colors takes more time than normal colors¹²

Fortunately, METAPOST provides a similar mechanism. The last circle in the following row demonstrates how we can trigger colors proportionally to other colors. Normally background is white, but you can set predefined color variables to another value.

```

path p ; p := fullcircle scaled 2cm ;
fill p shifted (0cm,0) withcolor blue ;

```

¹² When your printer does not support this feature natively, the intermediate (POSTSCRIPT) file send to the printing engine is also larger.

```
fill p shifted (3cm,0) withcolor .5blue ;
fill p shifted (6cm,0) withcolor transparent (1,0.5,blue) ;
fill p shifted (9cm,0) withcolor .5[blue,white] ;
```

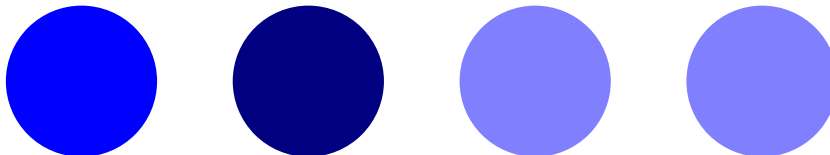

The next series demonstrates that we use the complementary factor `.7` in the METAPost soft color to achieve the same softness as the `.3` transparency.

```
path p ; p := fullcircle scaled 2cm ;
fill p shifted (0cm,0) withcolor red ;
fill p shifted (3cm,0) withcolor .7red ;
fill p shifted (6cm,0) withcolor transparent (1,0.3,red) ;
fill p shifted (9cm,0) withcolor .7[red,white] ;
```

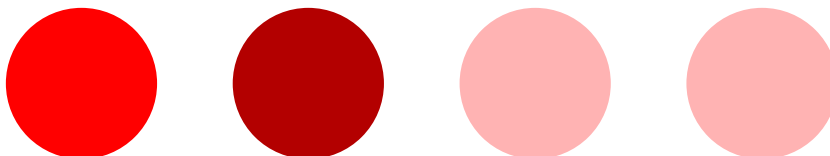

So far we have applied transparent colors to shapes but text can also be the target.

```
vardef SampleText (expr t, c) =
  save p ; picture p ;
  p := image (draw t infont "\truefontname{Regular}") ;
  draw (p shifted (- xpart center p,0)) scaled 5 withcolor c ;
enddef ;

SampleText ("Much Of This" , transparent(1, .5, red )) ;
SampleText ("Functionality" , transparent(1, .5, green)) ;
SampleText ("Was Written" , transparent(1, .5, blue )) ;
SampleText ("While Listening", transparent(1, .5, cmyk(1,0,0,0))) ;
SampleText ("To the CD's Of" , transparent(1, .5, cmyk(0,1,0,0))) ;
SampleText ("Tori Amos" , transparent(1, .5, cmyk(0,0,1,0))) ;
```

The source code of this example illustrates that the CMYK color space is also supported. The `\truefontname` macro communicates the running font from \TeX to METAPost. Instead of such low level code one can of course also use the `texttext` macro.

However, as we do the typesetting in \TeX in MKIV this is the way to go:

```
vardef SampleText (expr t) =
  draw texttext(t) scaled 5 ;
enddef ;

SampleText ("\colored[a=1,t=.5,r=1]{Much Of This}") ;
SampleText ("\colored[a=1,t=.5,g=1]{Functionality}") ;
SampleText ("\colored[a=1,t=.5,b=1]{Was Written}") ;
SampleText ("\colored[a=1,t=.5,c=1]{While Listening}") ;
```

```
SampleText ("\colored[a=1,t=.5,m=1]{To the CD's Of}") ;
SampleText ("\colored[a=1,t=.5,y=1]{Tori Amos}") ;
```

As expected we get:



Currently the 12 in PDF available transparency methods are supported.¹³ You can use both numbers and names. As you may expect, both CONTEXT and METAFUN support transparency in the same way. Figure 8.1 shows how the method affects the result.

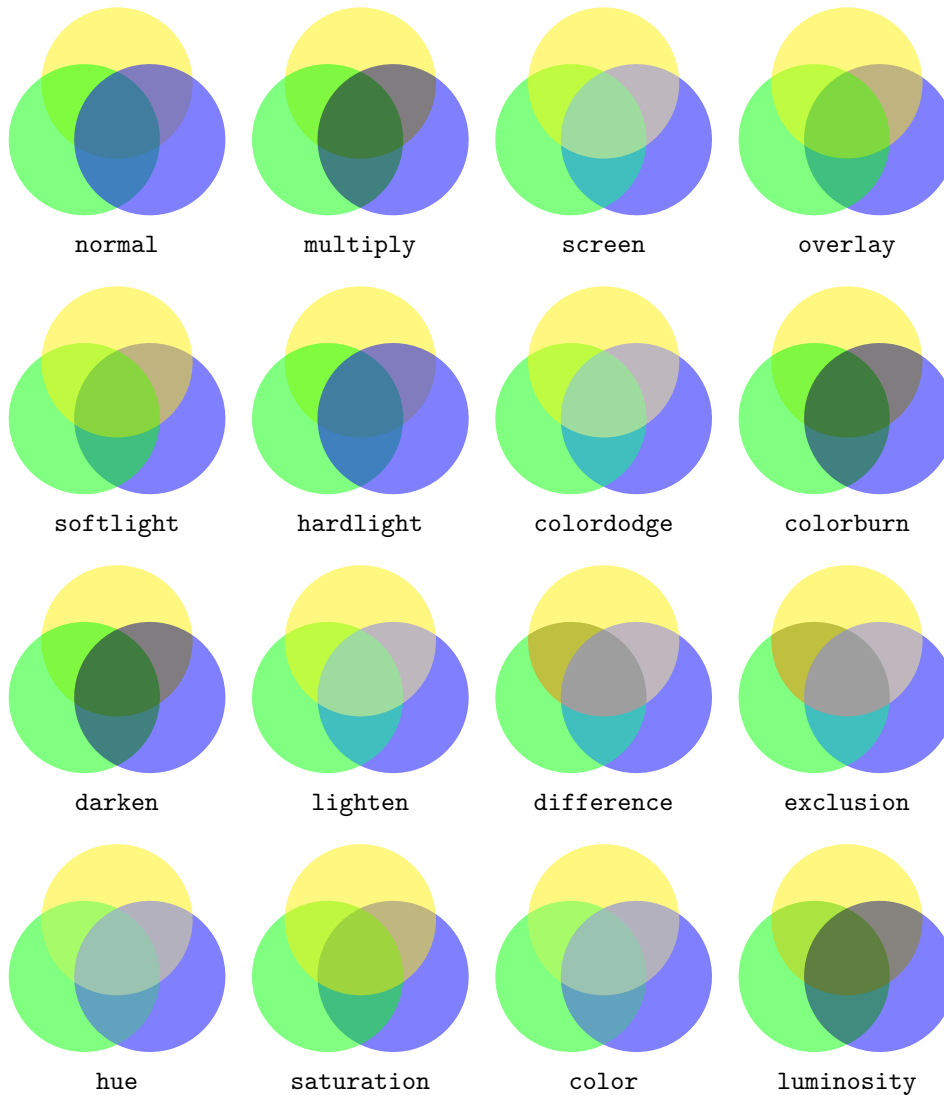

Figure 8.1 The 12 transparency alternatives by name.

¹³ In the future we may also support more control over the individual methods.

In `CONTEXT` a transparent color is defined in a similar way as ‘normal’ colors. The transparency method is specified with the `a` key (either by number or by name) and the factor `t`.

```
\definecolor [tred]    [r=1,t=.5,a=exclusion]
\definecolor [tgreen]  [g=1,t=.5,a=exclusion]
\definecolor [tblue]   [b=1,t=.5,a=exclusion]
```

Both keys are needed. You can define your own symbolic names using:

```
\definetransparency [myowndefault] [1]
```

The `\MPcolor` macro passes a color from `CONTEXT` to `METAPOST`, including the transparency specification.

```
\definecolor [tred]    [r=1,t=.5,a=exclusion]
\definecolor [tgreen]  [g=1,t=.5,a=exclusion]
\definecolor [tblue]   [b=1,t=.5,a=exclusion]
```



Of course this also works well for CMYK colors.

```
\definecolor [tred]   [c=1,k=.2,t=.5,a=1]
\definecolor [tgreen] [m=1,k=.2,t=.5,a=1]
\definecolor [tblue]  [y=1,k=.2,t=.5,a=1]
```



Gray scales work as well:

```
\definecolor [ta] [s=.9,t=.7,a=11]
\definecolor [tb] [s=.7,t=.7,a=11]
\definecolor [tc] [s=.5,t=.7,a=11]
```

We apply this to some text. By using an `overlay` we can conveniently explore the difference in fonts.

```
draw texttext("\color[ta]{\tf Hello}") scaled 5 ;
draw texttext("\color[tb]{\bf Hello}") scaled 5 ;
draw texttext("\color[tc]{\sl Hello}") scaled 5 ;
```

Hello

8.3 Shading

8.3.1 Introduction

In this section we introduce different kinds of shading. Since METAPOST does not support this feature directly, we have to fall back on a few tricks. For the moment shading is only supported in PDF. In the following examples, we will use the next three colors:

```
\definecolor [a] [darkyellow]
\definecolor [b] [s=.8]
\definecolor [c] [darkred]
```

Shading support evolved in steps and alongside development of the backend code. Also, as it became more used a second interface came available. We discuss both here.

8.3.2 The old method

First we discuss the old method which is still valid and also available in MKII. It illustrates some of the principles.

A shade is a fill with a stepwise change in color. In POSTSCRIPT (level 2), the way this color changes can be circular, linear, or according to a user defined function. Circular and linear shades look like this:

Hi there, I'm Circular!

Whow, this is Linear!

As you can see, the shade lays behind the text, as a background overlay. These overlays are unique METAPOST graphics, so they will adapt themselves to the dimensions of the foreground.

```
\defineoverlay [circular shade] [\uniqueMPgraphic{CircularShade}]
\defineoverlay [linear shade] [\uniqueMPgraphic{LinearShade}]
```

The two framed texts are defined as:

```
\framed
[background=circular shade,frame=off]
{\bf \white Hi there, I'm Circular!}
```

and:

```
\framed
[background=linear shade,frame=off]
{\bf \white Whow, this is Linear!}
```

We still have to define the graphics. Here we use a macro that takes four arguments: a path, a number identifying the center of shading, and the colors to start and end with.

```
\startuniqueMPgraphic{CircularShade}
```

```

path p ;
p := unitsquare xscaled \overlaywidth yscaled \overlayheight ;
circular_shade(p,0,\MPcolor{a},\MPcolor{b}) ;
\stopuniqueMPgraphic

\startuniqueMPgraphic{LinearShade}
path p ;
p := unitsquare xscaled \overlaywidth yscaled \overlayheight ;
linear_shade(p,0,\MPcolor{a},\MPcolor{b});
\stopuniqueMPgraphic

```

The METAPost macros, `circular_shade` and `linear_shade`, add information to the METAPost output file, which is interpreted by the converter built in `CONTEXT`. Shading comes down to interpolation between two or more points or user supplied ranges. A poor mans way of doing this, is to build the graphics piecewise with slightly changing colors. But, instead of ‘manually’ stepping through the color values, we can use the more efficient and generalized `POSTSCRIPT` level 2 and `PDF` level 1.3 shading feature.



circular 0 circular 1 circular 2 circular 3 circular 4



linear 1 linear 2 linear 3 linear 4



linear 5 linear 6 linear 7 linear 8

```

sh := define_circular_shade
  (origin,origin,0,8cm,\MPcolor{a},\MPcolor{b}) ;
for i=0 step 2cm until 8cm :
  fill fullcircle scaled 1cm shifted (i,0) withshade sh ;
endfor ;

```



The low level macro `define_circular_shade` is fed with two pairs (points), two radius, and two colors. The shade is distributed between the colors according to the radius.

Shading can hardly be called an easy issue. The macros that we provide here are in fact simplifications, which means that at a lower level, one can do more advanced things. Here we limit

ourselves to the more common cases. In the previous examples, we used an arrow to indicate the direction and magnitude of the shade. The next macro demonstrates the principles in a different way.

```
def test_shade (expr a, b, ra, rb) =
  pickup pencircle scaled 1mm ;

  color ca ; ca := \MPcolor{a} ;
  color cb ; cb := \MPcolor{b} ;
  color cc ; cc := \MPcolor{c} ;

  path pa ; pa := fullcircle scaled 2ra shifted a ;
  path pb ; pb := fullcircle scaled 2rb shifted b ;

  sh := define_circular_shade(a,b,ra,rb,ca,cb) ;

  fill pb withshade sh ;
  draw pb withcolor cc ;
  draw pa withcolor cc ;
enddef ;
```

The shade is distributed between two circles, each with a radius and center point. All four can be set, but as the next calls demonstrate, we can normally do with less, which is why we provided the macro with less parameters.

```
test_shade(origin, origin, 0cm, 1cm) ;
test_shade(origin, origin, .25cm, 1cm) ;
test_shade(origin, origin, .50cm, 1cm) ;
```

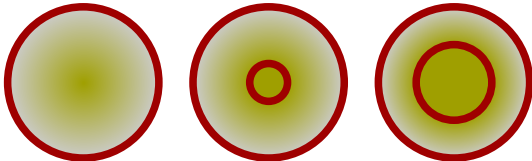

```
test_shade(origin, origin shifted (.25cm,0), 0cm, 1cm) ;
test_shade(origin, origin shifted (.25cm,0), .25cm, 1cm) ;
test_shade(origin, origin shifted (.25cm,0), .50cm, 1cm) ;
```

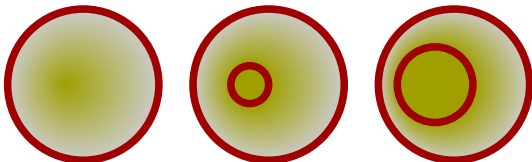

```
test_shade(origin shifted (.25cm,0), origin, 0cm, 1cm) ;
test_shade(origin shifted (.25cm,0), origin, .25cm, 1cm) ;
test_shade(origin shifted (.25cm,0), origin, .50cm, 1cm) ;
```

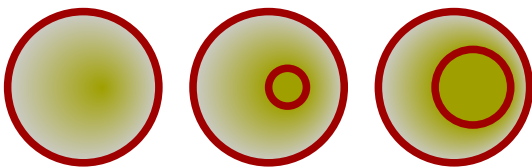

In a similar fashion, we can define a linear shade. This time we only pass two points and two colors.

```
def test_shade (expr a, b) =
  pickup pencircle scaled 1mm ;

  color ca ; ca := \MPcolor{a} ;
  color cb ; cb := \MPcolor{b} ;
  color cc ; cc := \MPcolor{c} ;

  sh := define_linear_shade(a,b,ca,cb) ;

  fill fullsquare scaled 2cm withshade sh ;
  draw a withcolor cc ;
  draw b withcolor cc ;
enddef ;
```

Although one can control shading to a large extent, in practice only a few cases really make sense.

```
test_shade(origin, origin shifted (1cm,0)) ;

test_shade(origin shifted (-1cm,0), origin shifted (1cm,0)) ;

test_shade(origin shifted (-1cm,-1cm), origin shifted (1cm,1cm)) ;
```

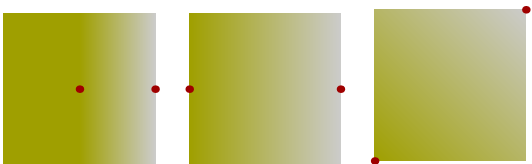

8.3.3 The new method

By now the shader macros are rather advanced and specifications are easier than before. Here we discuss the new method. An example is:

```
fill fullsquare xyscaled (TextWidth,1cm)
  withshademethod "linear"
  withshadevector (1,0)
  withshadecolors (darkred,darkgreen)
;
```



There are several properties that can be set:

- domain The range over which the colors run, with a minimum of 0 and maximum of 1.
- color A color to start from and one to end with, we default from black to white.

type The shading can be linear or circular.
 center The origin of the shade vector.
 radius The radius vector of a circular shade.
 vector Where we start and end the shading.

For a linear shade the centers are the lower left and upper right corners, for a circular shade it's the center of the path. For a circular shade the radius runs from zero to the maximum distance from the center as determined by the boundingbox.

The vector is used as follows: the first coordinate (xpart) determines the point on the path where we start, the second coordinate (ypart) the point on the path where we end.

```
fill fullsquare xyscaled (TextWidth,1cm)
  withshademethod "linear"
  withshadevector (1,0)
  withshadecolors (darkred,darkgreen)
;
```



In the end only the x coordinate matters, but using a point on the path sort of fits in METAPOST. In the case of a rectangle we have 4 points while circle has 8 points.

```
fill fullsquare xyscaled (TextWidth,1cm)
  withshademethod "linear"
  withshadevector (1,0)
  withshadecolors (darkred,darkgreen)
;
```



A triangle has three points. Using 1 and 2 as second vector value gives the same results as do values in the range 0 upto 1 and 2 upto 3 (0 again).

```
fill fullsquare xyscaled (TextWidth,1cm)
  withshademethod "linear"
  withshadevector (1,0)
  withshadecolors (darkred,darkgreen)
;
```



The shadevector relates to (the x coordinates of) points on the path. A variant is to use the boundingbox:

```
for i=1 upto 3 :
  fill fulltriangle xyscaled (TextWidth,1cm)
    shifted (0,-i*15mm)
    withshademethod "linear"
    withshadedirection (1,1-i/4)
```



```

        withshadecolors (darkgreen,darkblue)
    ;
endfor ;

```

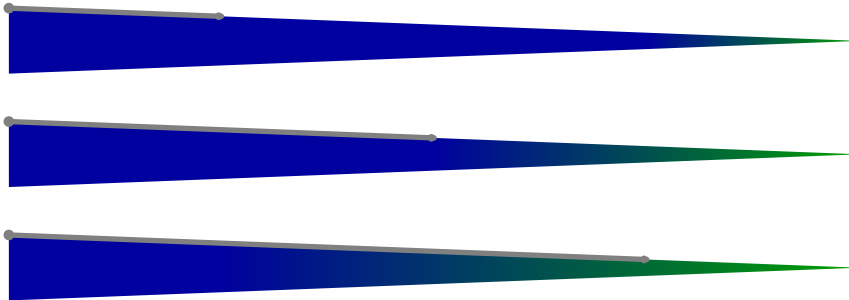

So, where a vector is defined as going from *point xpart a of pth* to *point ypart a of pth*, a direction goes from *point xpart a of boundingbox pth* to *point ypart a of boundingbox pth*.

To make life convenient we provide a few constants that indicate directions:

```

pair shadedup    ; shadedup    := (0.5,2.5) ;
pair shadeddown  ; shadeddown  := (2.5,0.5) ;
pair shadedleft  ; shadedleft  := (1.5,3.5) ;
pair shadedright ; shadedright := (3.5,1.5) ;

for d = shadedup, shadeddown, shadedleft, shadedright :
    fill fullsquare xyscaled (TextWidth,1cm)
        withshademethod "linear"
        withshadedirection d
        withshadecolors (darkgreen,darkblue)
    ;
    currentpicture := currentpicture shifted (0,15mm) ;
endfor ;

```

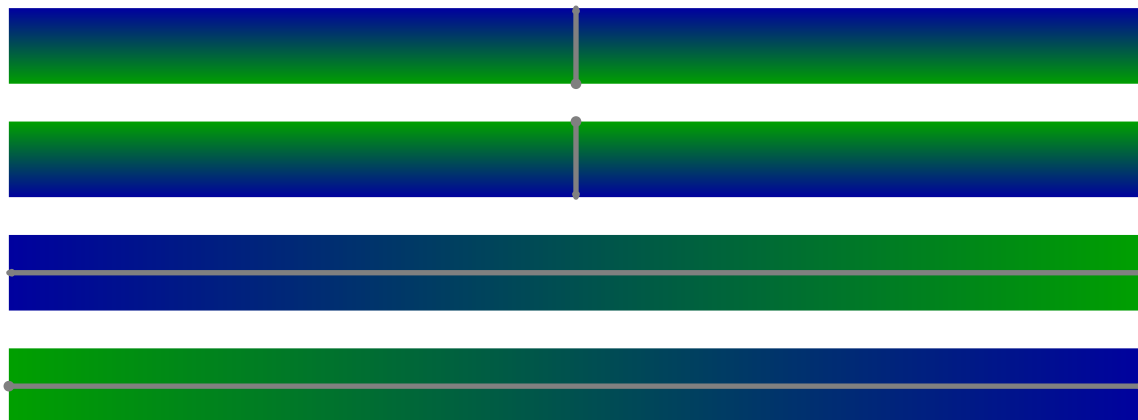

In case of a circular shade another method comes in handy:

```

fill fullsquare xyscaled (TextWidth,1cm)
    withshademethod "linear"
    withshadevector (1,0)
    withshadecolors (darkred,darkgreen)

```

;

Here the values relate to the center of path i.e. they shift the center by the given fraction of the width and height of the boundingbox divided by 2.

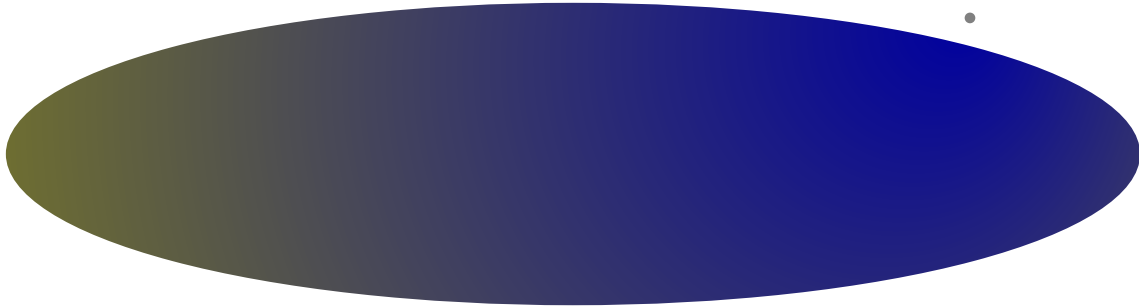

You can set a center directly i.e. unrelated to the center of the path as follows:

```
fill fullsquare xyscaled (TextWidth,1cm)
  withshademethod "linear"
  withshadevector (1,0)
  withshadecolors (darkred,darkgreen)
;
```



In a similar way you can set an explicit radius:

```
fill fullsquare xyscaled (TextWidth,1cm)
  withshademethod "linear"
  withshadevector (1,0)
  withshadecolors (darkred,darkgreen)
;
```

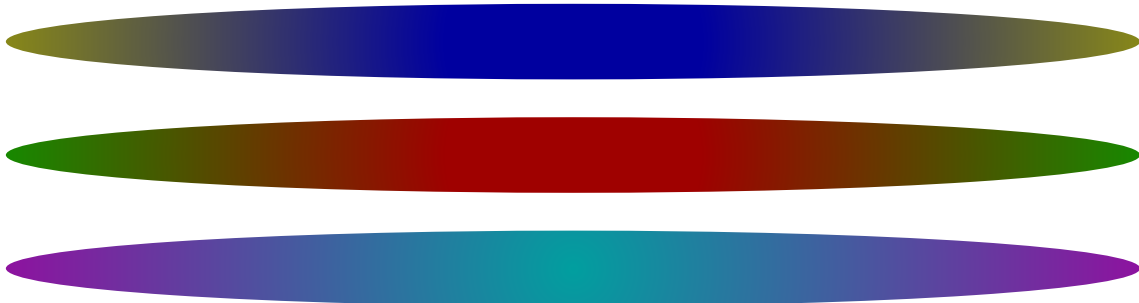

A more fancy feature is combined shades. This works as follows:

```

fill fullsquare xyscaled (TextWidth,1cm)
  withshademethod "linear"
  withshadevector (0,1)
  withshadestep (
    withshadefraction .3
    withshadecolors (red,green)
  )
  withshadestep (
    withshadefraction .5
    withshadecolors (green,blue)
  )
  withshadestep (
    withshadefraction .7
    withshadecolors (blue,red)
  )
  withshadestep (
    withshadefraction 1
    withshadecolors (red,yellow)
  )
;

```

By stepwise defining the colored bands you get:



Shades work well with colors and transparencies. This involves quite some resource management in the backend but it's hidden by the interface.

Here are some shades without transparency:

```

fill fullsquare scaled 5cm
  withshademethod "linear"
  withshadefactor 1
  withshadedomain (0,1)
  withshadevector (0.5,2.75)
  withshadecolors (red,green) ;

fill fullcircle scaled 5cm
  withshademethod "circular"
  withshadefactor 1
  withshadedomain (0,1)
  withshadecenter (.25,.25)
  withshadecolors (green,blue) ;

fill fulltriangle scaled 5cm
  withshademethod "circular"
  withshadefactor 1
  withshadedomain (0,1)
  withshadecenter (.25,.25)
  withshadecolors (blue,yellow) ;

```

When the background is white, transparency is just a way to achieve soft colors. We leave out the defaults.

```
fill fullsquare scaled 5cm
  withcolor white ;
fill fullsquare scaled 5cm
  withshademethod "linear"
  withshadecolors (red,green)
  withshadecolors (red,green)
  withtransparency (1,.5) ;

fill fullcircle scaled 5cm
  withcolor white ;
fill fullcircle scaled 5cm
  withshademethod "circular"
  withshadecenter (.25,.25)
  withshadecolors (green,blue)
  withtransparency (1,.5) ;

fill fulltriangle scaled 5cm
  withcolor white ;
fill fulltriangle scaled 5cm
  withshademethod "circular"
  withshadecenter (.25,.25)
  withcolor blue shadedinto yellow
  withtransparency (1,.5) ;
```

Real transparency will show up darker due to the accumulated colors. This time we demonstrate an alternative color specification.

```
fill fullsquare scaled 5cm
  withshademethod "linear"
  withshadecolors (red,green)
  withshadecolors (red,green)
  withtransparency (1,.5) ;

fill fullcircle scaled 5cm
  withshademethod "circular"
  withshadecenter (.25,.25)
  withcolor green shadedinto blue
  withtransparency (1,.5) ;

fill fulltriangle scaled 5cm
  withshademethod "circular"
  withshadecenter (.25,.25)
  withcolor blue shadedinto yellow
  withtransparency (1,.5) ;
```

Within reasonable bounds you can move around and adapt shaded paths but you need to keep in mind that due to the fact that we are dealing with relatively complex data structures there are some limits. For instance it is possible to define a shade as (kind of) variable and reuse it. it's also possible then to overload some properties.

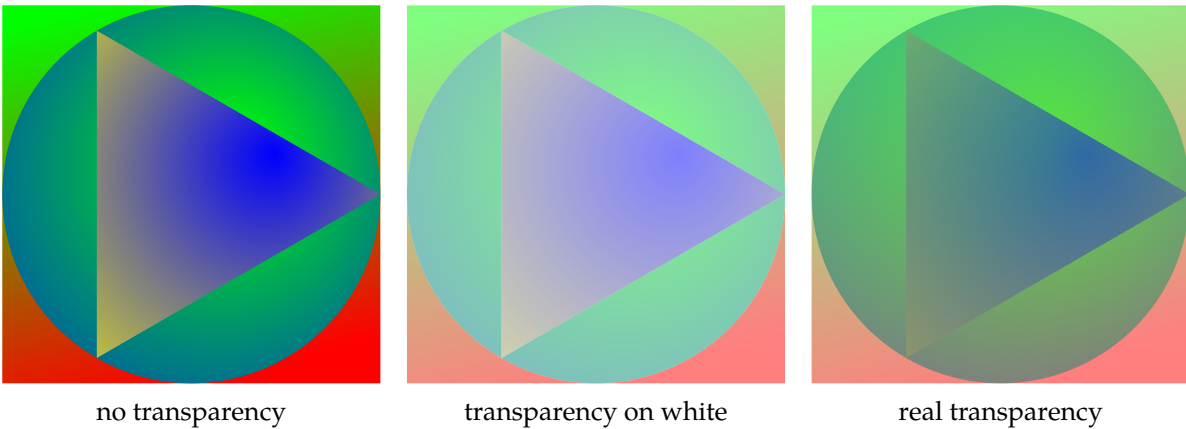

Figure 8.2 Transparency applied to shades.

```

defineshade myshade
  withshademethod "circular"
  withshadefactor 1
  withshadedomain (0,1)
  withshadecolors (black,white)
  withtransparency (1,.5)
;
for i=1 upto 5 :
  fill fullcircle randomized 1 xyscaled(5cm,3cm)
    shaded myshade ;
endfor ;

draw image (
  for i=1 upto 5 :
    fill fullcircle randomized 1
      shaded myshade
        withshadecolors (yellow,blue) ;
  endfor ;
) xyscaled(5cm,3cm) shifted (5cm,0) ;

```

We get two groups of five overlaid shades here, one with a different color. The shade properties can only be applied to paths (see figure 8.3).

In older versions one could not reposition or scale a shaded path without losing or crippling the shade properties. Nowadays this is no longer a limitation, as we demonstrate in the following examples. You can disable this feature if wanted. The results are shown in figure 8.4. Without the transform the vectors and such are kept which might be useful in special cases.

```

fill fullsquare xyscaled (15mm, 15mm)
  withshademethod "linear"
  withshadedirection shadedright
  withshadecolors (red,(1,1,1)) ;

fill fullsquare xyscaled (10mm, 10mm)
  withshademethod "circular"
  withshadecolors (green,blue) ;

```

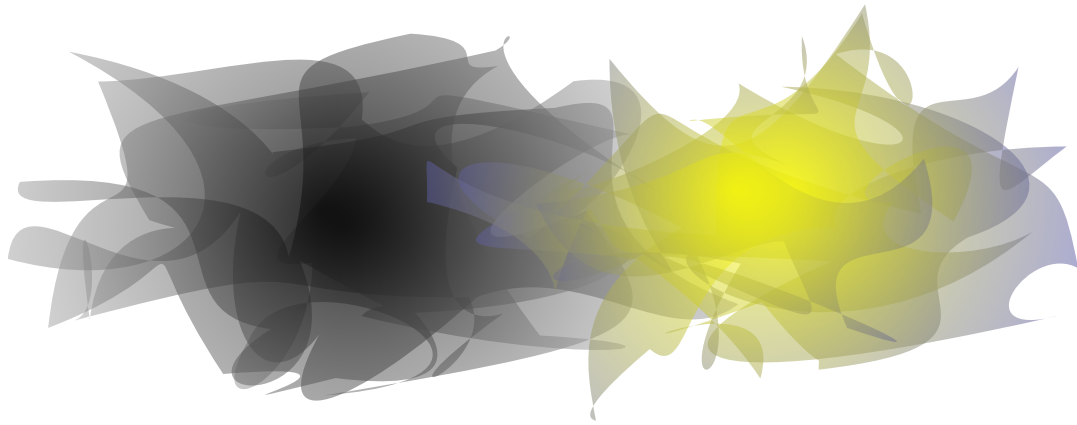

Figure 8.3 Reusing defined shaded.

```
currentpicture := currentpicture xysized (.4TextWidth,30mm) ;
currentpicture := currentpicture shifted (5mm,5mm) ;
```

The transform can be ignored with:

```
fill fullsquare xyscaled (15mm, 15mm)
  withshademethod "linear"
  withshadetransform "no"
  withshadedirection shadedright
  withshadecolors (red,(1,1,1)) ;

fill fullsquare xyscaled (10mm, 10mm)
  withshademethod "circular"
  withshadetransform "no"
  withshadecolors (green,blue) ;

currentpicture := currentpicture xysized (.4TextWidth,30mm) ;
currentpicture := currentpicture shifted (5mm,5mm) ;
```

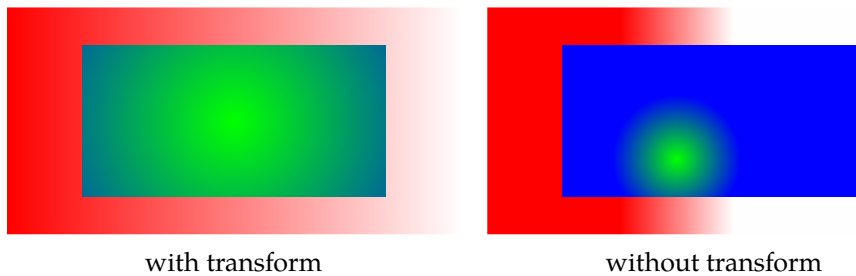

Figure 8.4 Shifting and scaling shades.

8.4 Clipping

In this section we will use the graphic representation (although simplified) of a Dutch cow to demonstrate clipping.

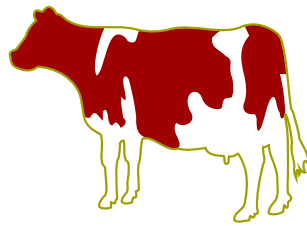

Figure 8.5 A cow.

Since this cow is defined as a METAPOST graphic, we use the suffix `mps` instead of `eps` or a number, although `CONTEXT` will recognize each as being METAPOST output. The placement of the cow is defined as:

```
\placefigure
  {A cow.}
  {\externalfigure[cow-fun.mps] [width=4cm]}
```

Clipping is combined with a matrix, as in figure 8.6. The content to be clipped is divided in `nx` by `ny` rectangles. For instance, `nx=5` and `ny=8` will produce a 40 cell grid with 5 columns of 8 rows.

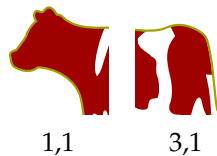

Figure 8.6 A clipped cow.

Here we have divided the cow in six cells, so that we can clip its head and tail. This kind of clipping enables you to zoom in or focus on a specific part of a graphic.

```
\setupclipping[nx=3,ny=2]
\startcombination
  {\clip[x=1,y=1]{\externalfigure[cow-fun.mps] [width=4cm]}} {1,1}
  {\clip[x=3,y=1]{\externalfigure[cow-fun.mps] [width=4cm]}} {3,1}
\stopcombination
```

Alternatively, we can specify a width, height, hoffset and voffset, as demonstrated in figure 8.7.

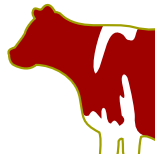

Figure 8.7 Another clipped cow.

```
\placefigure
  [here] [fig:clipped cow 2]
  {Another clipped cow.}
  {\clip
    [width=2cm,height=2cm,hoffset=0cm,voffset=0cm]
    {\externalfigure[cow-fun.mps] [width=4cm]}}
```

Because METAPOST supports clipping, it will be no surprise that both techniques can be combined. In the next example we will zoom in on the head of the cow. We also use this opportunity to demonstrate how you can package a clip in a figure definition.

```
\startMPclip{head clip}
  w := \width ; h := \height ;
  clip currentpicture to
    ((0,h)--(w,h){down}..{left}(0,0)--cycle) ;
\stopMPclip

\placefigure
  [here][fig:circular clipped cowhead]
  {A quarter circle applied to a cows head.}
  {\ruledhbox
    {\clip
      [nx=2,ny=2,x=1,y=1,mp=head clip]
      {\externalfigure[cow-fun.mps][width=4cm]}}}
```

A more advanced clip is demonstrated in figure 8.8. We added `\ruledhbox` to demonstrate the dimensions of the resulting graphic. Putting something in such a ruled box is often a quick way to test spacing.

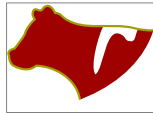

Figure 8.8 A quarter circle applied to a cows head.

Although a clip path definition can contain any METAPOST command, even graphics, it must contain at least one clipping path. The first one encountered in the resulting graphic is used. In the example we used a path that is built out of three subpaths.

```
(0,h)--(w,h){down}..{left}(0,0)--cycle
```

We start in the top left corner and draw a straight line. Next we draw a curve to the origin. Directives like `down` and `right` force the curve in a certain direction. With `cycle` we close the path. Because we use this path as a clipping path, we use `clip` instead of `draw` or `fill`.



Clipping as such is not limited to graphics. Take for instance the text buffer:

```
\startbuffer[sample]
\framed
  [align=middle,width=4cm,background=screen,frame=off]
  {A \METAPOST\ clip is not the same as a video clip,
   although we can use \METAPOST\ to produce a video clip.}
\stopbuffer
```

We can call up such a buffer as if it were an external figure. Figure 8.9 shows the result. This time we use a different clip path:

```
\startMPclip{text clip}
  clip currentpicture to fullcircle shifted (.5,.5)
  xscaled \width yscaled \height ;
\stopMPclip
```

To load a buffer, we have to specify its name and type, as in:

```
\placefigure
[here][fig:clipped text 1]
{A clipped buffer (text).}
{\clip
[nx=1,ny=1,mp=text clip]
{\externalfigure[sample][type=buffer,width=4cm]}}
```

. METAPOST clip is in
the same as a video
clip, although we
can use METAPOST to
produce a video clip

Figure 8.9 A
clipped buffer (text).

The next few lines demonstrate that we can combine techniques like backgrounds and clipping.

```
\startuseMPgraphic{clip outline}
draw fullcircle
  xscaled \overlaywidth yscaled \overlayheight
  withpen pencircle scaled 4mm
  withcolor .625red ;
\stopuseMPgraphic

\defineoverlay[clip outline][\useMPgraphic{clip outline}]

\placefigure
[here][fig:clipped text 2]
{A clipped buffer (text).}
{\framed
[background=clip outline,offset=overlay,frame=off]
{\clip
[nx=1,ny=1,mp=text clip]
{\externalfigure[sample][type=buffer,width=4cm]}}}
```

We could have avoided the `\framed` here, by using the `clip outline` overlay as a background of the sample. In that case, the resulting linewidth would have been 2.5 mm instead of 5 mm, since the clipping path goes through the center of the line.

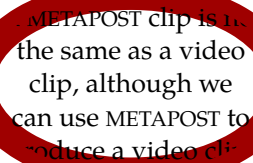

METAPOST clip is the same as a video clip, although we can use METAPOST to produce a video clip.

Figure 8.10 A clipped buffer (text).

In most cases, the clip path will be a rather simple path and defining such a path every time you need it, can be annoying. Figure 8.11 shows a collection of predefined clipping paths. These are available after loading the METAPOST clipping library.

```
\useMPlibrary[clip]
```

We already saw how the circular clipping path was defined. The diamond is defined in a similar way, using the predefined path `diamond`:

```
\startMPclip{diamond}
  clip currentpicture to unitdiamond
  xscaled \width yscaled \height ;
\stopMPclip
```

The definition of the negated ellipse (`negellipse`) uses the primary `peepholed`. This primary is defined in one of the METAPOST modules that come with `CONTEX`.

```
\startMPclip{negellipse}
  clip currentpicture to (unitcircle peepholed unitsquare)
  xscaled \width yscaled \height ;
\stopMPclip
```

The definition of `peepholed` is rather dirty and using `peepholed` is restricted to well defined situations (like here). It's called a primary because it acts as an operator at the same level as `*` and `scaled`.

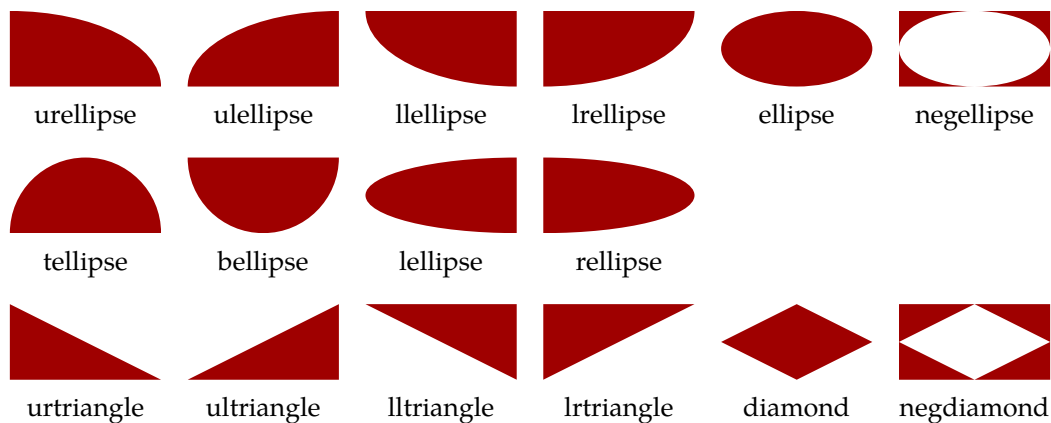

Figure 8.11 A collection of predefined clipping paths.

8.5 Including graphics

This document demonstrates that it is no big problem to include METAPOST graphics in a \TeX document. But how about including graphics in a METAPOST picture? In this section we will explore a couple of macros that provide you this feature.

Before we go into details, we introduce a very impressive program called PSTOEDIT by Wolfgang Glunz. This program runs on top of GHOSTSCRIPT and is able to convert POSTSCRIPT code into other formats, among them METAPOST (that part of the PSTOEDIT code is due to Scott Pakin). Some of the graphics that we use in this section are produced that way. For us, the next call works well, but the exact call may differ per version or platform.

```
pstoedit -ssp -dt -f mpost yourfile.ps newfile.mp
```

We have converted the Dutch cow that shows up in many CONTEXT documents into METAPOST using this program. The resulting METAPOST file encapsulates the cow in METAPOST figure 1: `beginfig(1)`. Of course you can process this file like any other, but more interesting is to use this code in an indirect way.

```
loadfigure "mycow.mp" number 1 scaled .5 ;
```

This call will load figure 1 from the specified METAPOST file, in such a way that there is no interference with the current (encapsulating) figure.

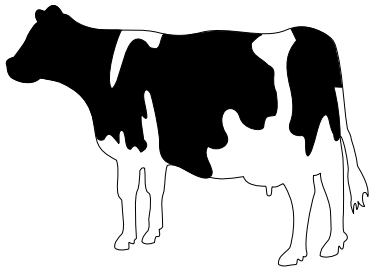

Because this graphic is the result from a conversion, there are only paths. If you want to import a more complex graphic, you need to make sure that the variables used in there do not conflict with the one currently in use.

METAPOST is good in drawing vector graphics, but lacks natural support for bitmaps, but the next macro offers a way out. This macro permits you to include graphics in PNG, PDF, and JPG format, or more precise: those formats supported by $\text{PDF}\TeX$.

```
draw externalfigure "hacker.png" scaled 5cm shifted (-6cm,0) ;
draw externalfigure "hacker.png" scaled 5cm slanted .5 ;
```

You can apply the usual transformations, but only those applied directly will be taken into account. This means that you (currently) cannot store external figures in picture variables in order to transform them afterwards.

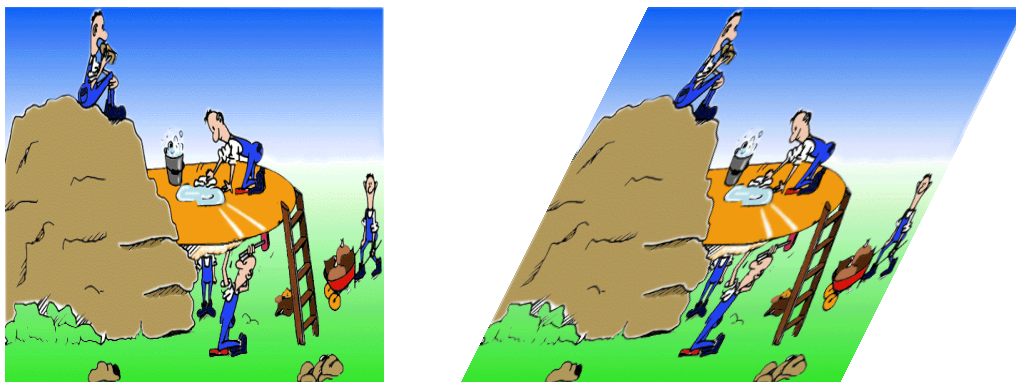

Although you are limited in what you can do with such graphics, you can include them multiple times with a minimum of overhead. Graphics are stored in objects and embedded only once.

```

numeric s ; pair d, c ;
for i := 1 upto 5 :
  s := 3cm randomized 1cm ;           % size of picture
  c := .5(s,s) ;                       % center of picture
  d := (2cm*i,.5cm) randomized .5cm ; % displacement
  draw externalfigure "hacker.png"
    scaled s rotatedaround (c,0 randomized 30) shifted d ;
endfor ;

```

Because we cannot store the graphic in a picture and scale afterwards, we calculate the scale in advance, so that we can rotate around the center.



As long as you don't mess around with a stored external figure, you're safe. The following example demonstrates how we can combine two special driven features: figure inclusion and shading.

```

picture p ;
p := externalfigure "hacker.png" scaled 150pt ;
clip p to unitcircle scaled 150pt ;
circular_shade(boundingBox p enlarged 10pt, 0, .2red, .9red) ;
addto currentpicture also p ;

```



We end this section with a few more words to METAPOST inclusion. It may seem that in order to use the features discussed here, you need to use CONTEX as typesetting engine. This is not true. First of all, you can use the small T_EX package MPTOPDF (described in another manual) or you can make small CONTEX files with one page graphics. The advantage of the last method is that you can manipulate graphics a bit.

```
\setupcolors[cmyk=yes,rgb=no,state=start]
\starttext
\startMPpage[offset=6pt]
  loadfigure "niceone.mp" number 10 ;
\stopMPpage
\stoptext
```

The resulting PDF file can be included as any other graphic and has the advantage that it is self contained.

8.6 Changing colors

One of the advantages of METAPOST graphics is that it is rather easy to force consistency in colors and line widths. You seldom can influence third party graphics that way, but we can use some METAFUN trickery to get around this limitation.

Say that we want a red cow instead of a black one. The following code does the trick:

```
loadfigure "mycow.mp" number 1 scaled .35 ;
refill currentpicture withcolor .625red ;
```

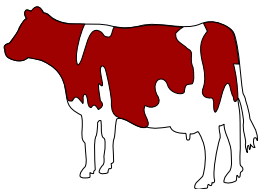

In a similar way we can influence the width and colors of the lines.

```
loadfigure "mycow.mp" number 1 scaled .35 ;
```

```
refill currentpicture withcolor .625red ;
redraw currentpicture withpen pencircle scaled 2pt withcolor .625yellow ;
```

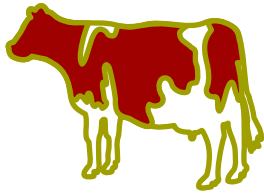

Of course we can also use the more fancy features of METAFUN, like transparency and shading.

```
loadfigure "mycow.mp" number 1 scaled .35 ;
numeric sh ; sh := define_linear_shade
  (llcorner currentpicture,urcorner currentpicture,.625red, .625yellow) ;
refill currentpicture withshade sh ;
redraw currentpicture withpen pencircle scaled 2pt withcolor .5white;
```

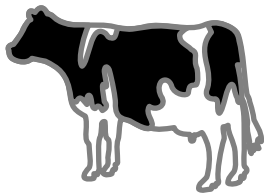

Before we show a next trick, we draw a few circles.

```
fill fullcircle scaled 2cm withcolor yellow ;
fill fullcircle scaled 2cm shifted (3cm,0) withcolor red ;
```

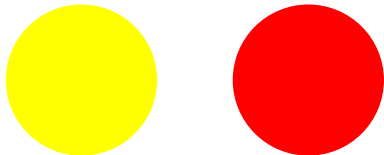

The yellow and red color do not match the main document colors, but this is no problem: we can remap them, without spoiling the original definition.

```
fill fullcircle scaled 2cm withcolor yellow ;
fill fullcircle scaled 2cm shifted (3cm,0) withcolor red ;

remapcolor(yellow,.625yellow) ;
remapcolor(red ,.625red) ;
recoler currentpicture ;
resetcolormap ;
```



We can combine the inclusion technique with remapping colors. This time using an artist impression of one of Hasselts Canals (gracht in Dutch).

```
loadfigure "gracht.mp" number 1 scaled .5 ;
```



If you think that the sky is too bright in this picture, and given that you also know which color is used, you can fool the reader by remapping a few colors.

```
loadfigure "gracht.mp" number 1 scaled .5 ;

color skycolor ; skycolor := (0.8,0.90,1.0) ;
color watercolor ; watercolor := (0.9,0.95,1.0) ;
remapcolor(skycolor ,.8skycolor ) ;
remapcolor(watercolor,.8watercolor) ;
recolor currentpicture ;
resetcolormap ;
```



Including another METAPOST graphic, refilling, redrawing, and recoloring are all relatively simple features that use no real tricks. Opposite to the next feature, which is implemented using the METAPOST special driver that comes with CONTEXT.

METAPOST is not really meant for manipulating graphics, but the previous examples demonstrated that we have some control over individual colors. In the next series of examples we will treat the picture as a whole. First we invert the colors using `inverted`.

```
loadfigure "gracht.mp" number 1 scaled .5 ;
addto currentpicture also
  inverted currentpicture
  shifted (bbwidth(currentpicture)+.5cm,0) ;
```



This is a special case of uncolored. In the next example we explicitly specify the color.

```
loadfigure "gracht.mp" number 1 scaled .5 ;
addto currentpicture also
  (currentpicture uncolored green)
  shifted (bbwidth(currentpicture)+.5cm,0) ;
```

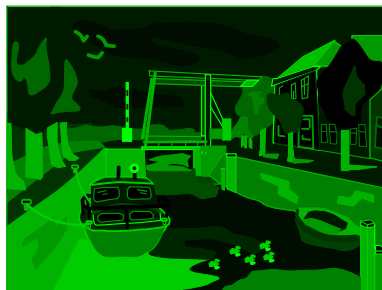

You can also multiply each color using softened. In the next sample, the colors have 80% of their value.

```
loadfigure "gracht.mp" number 1 scaled .5 ;
addto currentpicture also
  (currentpicture softened .8)
  shifted (bbwidth(currentpicture)+.5cm,0) ;
```



You can also use this operator to harden colors, simply by providing a value larger than 1. Keep in mind that colors are clipped at 1 anyway.

```
loadfigure "gracht.mp" number 1 scaled .5 ;
addto currentpicture also
  (currentpicture softened 1.2)
  shifted (bbwidth(currentpicture)+.5cm,0) ;
```

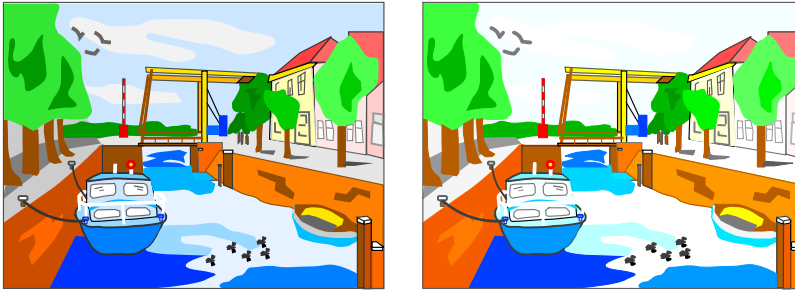
By providing a triplet, you can treat each color component independently.

```
loadfigure "gracht.mp" number 1 scaled .5 ;
addto currentpicture also
  (currentpicture softened (.7,.8,.9))
  shifted (bbwidth(currentpicture)+.5cm,0) ;
```

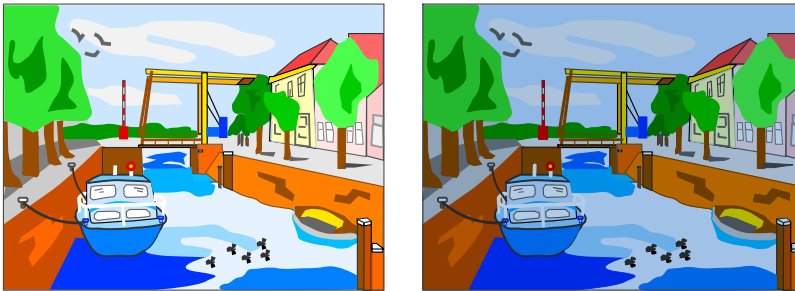

After these examples you are probably sick of seeing this picture in color, so let's turn the colors into a weighted grayscale (in a way similar to the way black and white television treated color).

```
loadfigure "gracht.mp" number 1 scaled .5 ;
addto currentpicture also
  grayed currentpicture
  shifted (bbwidth(currentpicture)+.5cm,0) ;
```

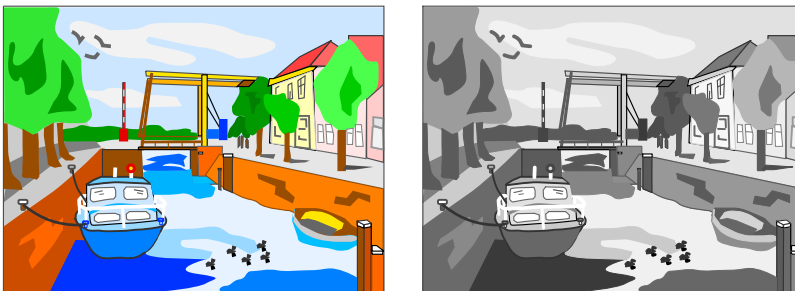

8.7 Outline fonts

Outline fonts don't belong to METAPOST's repertoire of features. Nevertheless we can simulate this in a reasonable way. The current version of METAFUN uses the outline subsystem of CONTEXT MKIV, but in earlier days we used an external process: a PDF file is generated that has the snippet, that gets converted to POSTSCRIPT, which in turn is converted to METAPOST with pstoeedit and from

that result we filter the outlines. This method uses `graphictext` and is covered in the `MAKEMPY` manual. Here we discuss the new method using `outlinetext`.

```
draw outlinetext.b("\bf Funky")
  (withcolor .5white)
  (withcolor blue withpen pencircle scaled 1/5)
  scaled 4 zscaled (1,0.5) ;
```

Once the text is typeset by $\text{T}_{\text{E}}\text{X}$, the result (a node list) is parsed and a `METAPOST` representation is created. The glyphs are converted to outlines that are taken from the original font. For the moment this only works for `OPENTYPE` fonts.

Funky

Funky	<code>draw outlinetext (" \bf Funky") scaled 3 ;</code>
Funky	<code>draw outlinetext.d (" \bf Funky") (withcolor red withpen pencircle scaled 1/5) scaled 3 ;</code>
Funky	<code>draw outlinetext.f (" \bf Funky") (withcolor blue) scaled 3 ;</code>
Funky	<code>draw outlinetext.b (" \bf Funky") (withcolor blue) (withcolor red withpen pencircle scaled 1/5) scaled 3 ;</code>
Funky	<code>draw outlinetext.r (" \bf Funky") (withcolor blue) (withcolor red withpen pencircle scaled 1/5) scaled 3 ;</code>

Table 8.1 The four variants of `graphictext`.

The five variants of this command are shown in table 8.1: the suffix determines the number of arguments and rendering. The `r` suffix reverses the order: the fill comes over the draw. There is a `p` suffix that returns just the picture.

The next example demonstrates that you can combine $\text{T}_{\text{E}}\text{X}$'s powerful line breaking algorithm with `METAPOST`'s graphic capabilities.

```
\startuseMPgraphic{quotation}
```

```

picture one ; one := image ( draw outlinetext.b
  (\MPstring{text})
  (withcolor .625white)
  (withcolor .625blue withpen pencircle scaled 1/5)
  scaled 1.5
) ;
picture two ; two := image ( draw outlinetext.b
  (\MPstring{author})
  (withcolor .625white)
  (withcolor .625red withpen pencircle scaled 1/5)
  scaled 2
) ;
currentpicture := one ;
addto currentpicture also two
  shifted lrcorner one
  shifted - 1.125 lrcorner two
  shifted (0, - 2 * ypart urcorner two) ;
setbounds currentpicture to boundingbox currentpicture enlarged 3pt ;
\stopuseMPgraphic

```

In this graphic, we have two text fragments, the first one is a text, the second one the name of the author. We combine the quotation and author into this graphic using the following definitions:

```

\setMPtext
{text}
{\vbox
  {\setupalign[verytolerant,stretch]
  \hsize 8.5cm
  \input zapf }}
\setMPtext
{author}
{\hbox
  {\sl Hermann Zapf}}

```

These definitions assume that the file `zapf.tex` is present on the system (which is the case when you have installed `CONTEXT`). The graphic can now be typeset using the following call:

```

\placefigure
[here]
[fig:zapf]
{A text does not need to be an outline in order to be
typeset in an outline font.}
{\useMPgraphic{quotation}}

```

The result is figure 8.12. The quality of the output depends on how the glyphs are constructed. For instance, in $\text{T}_{\text{E}}\text{X}$, math symbols are sometimes composed of glyph fragments and rules.

```

draw outlinetext.d
("\mathematics{\sqrt{1+x}}")
(withcolor .625red withpen pencircle scaled 1/5)
scaled 8

```

Coming back to the use of typefaces in electronic publishing: many of the new typographers receive their knowledge and information about the rules of typography from books, from computer magazines or the instruction manuals which they get with the purchase of a PC or software. There is not so much basic instruction, as of now, as there was in the old days, showing the differences between good and bad typographic design. Many people are just fascinated by their PC's tricks, and think that a widely-praised program, called up on the screen, will make everything automatic from now on.

Hermann Zapf

Figure 8.12 A text does not need to be an outline in order to be typeset in an outline font.

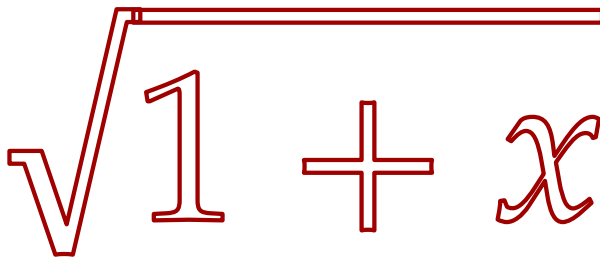

This is not really a problem because we can also fill the shapes. It is the reason why the fill is applied after the draw and in such case the effective line width is half the size specified.

```
draw outlinetext.b
  ("\"mathematics{\left({\sqrt{1+x}}\over{\sqrt{2+x^2}}\right)}")
  (withcolor .850white)
  (withcolor .625red
   dashed evenly scaled .1
   withpen pencircle scaled 1/5)
  scaled 8
```

In this example (shown in figure 8.13) we also use a dashed line.

Instead of supplying the text directly, you can use the indirect method. This permits you to process rather complex data without messing up your METAPOST code.

```
\usemodule[mathml]
\setMPtext {some math}%
  {\xmlprocessdata
```

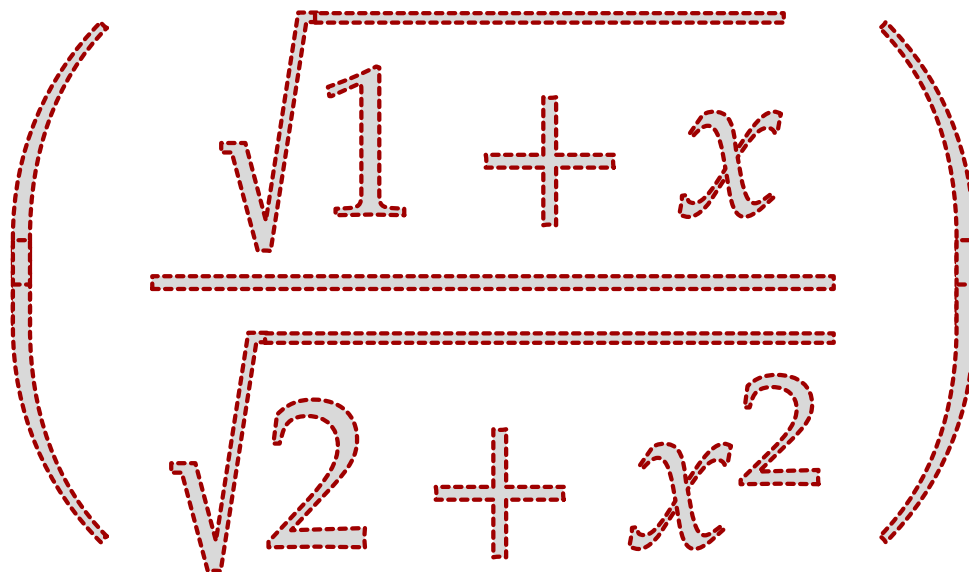

Figure 8.13 A dashed outline text.

```
{main}
{<math xmlns='http://www.w3c.org/mathml' version='2.0'>
  <apply> <log/>
    <logbase> <cn> 2 </cn> </logbase>
    <apply> <plus/>
      <ci> x </ci>
      <cn> 1 </cn>
    </apply>
  </apply>
</math>}
{}}
```

Here we feed some MATHML into \TeX , which in turn shows up as a METAPost graphic (figure 8.14).

```
draw outlinetext.b
(\MPstring{some math})
(withcolor .625white)
(withcolor .625red withpen pencircle scaled 1/5)
scaled 8
```

Figure 8.14 A MATHML snippet turned into outlines.

Outlines are fun to look at. Here are a few ways to visualize a glyph:

```

\startcombination[3*1]
  {\ruledhbox\bgroup
   \showshape[character=(,alternative=text]%
   \egroup} {}
  {\ruledhbox\bgroup
   \showshape[character=a,alternative=text]%
   \egroup} {}
  {\ruledhbox\bgroup
   \showshape[character=x,alternative=text]%
   \egroup} {}
\stopcombination

```

You can control the rendering a bit by setting option. Possible options are: `box`, `width`, `min`, `max` and `comment`. The `simple` option disables all. The simple results are shown in figure 8.15.

```

\startcombination[3*1]
  {\ruledhbox\bgroup
   \showshape[character=(,alternative=text,option=simple]%
   \egroup} {}
  {\ruledhbox\bgroup
   \showshape[character=a,alternative=text,option=simple]%
   \egroup} {}
  {\ruledhbox\bgroup
   \showshape[character=x,alternative=text,option=simple]%
   \egroup} {}
\stopcombination

```

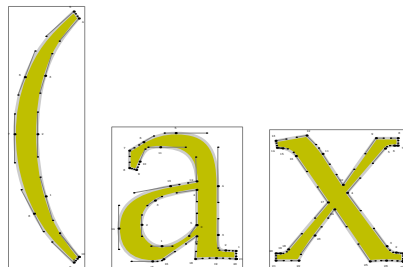

Figure 8.15 Showing shapes.

When you use this feature you need to be aware of the fact that fonts can have features, for instance ligatures and kerns between characters. In figure 8.16 we see a few examples with and without features, one with Pagella (the Zapf quote) and one with Optima Nova (the Tufte quote).

Given that a shape has a path that is suitable for it, you can use special effects, like:

```

draw image (
  draw outlinetext.d
  ("Abracadabra")
  (withpen pencircle scaled 1/10 dashed withdots scaled 1/20) ;
) xsized TextWidth ;

```

Coming back to the use of typefaces in electronic publishing: many of the new typographers receive their knowledge and information about the rules of typography from books, from computer magazines or the instruction manuals which they get with the purchase of a PC or software. There is not so much basic instruction, as of now, as there was in the old days, showing the differences between good and bad typographic design. Many people are just fascinated by their PC's tricks, and think that a widely-praised program, called up on the screen, will make everything automatic from now on.

pagella / no features

Coming back to the use of typefaces in electronic publishing: many of the new typographers receive their knowledge and information about the rules of typography from books, from computer magazines or the instruction manuals which they get with the purchase of a PC or software. There is not so much basic instruction, as of now, as there was in the old days, showing the differences between good and bad typographic design. Many people are just fascinated by their PC's tricks, and think that a widely-praised program, called up on the screen, will make everything automatic from now on.

pagella / default features

We thrive in information-thick worlds because of our marvelous and everyday capacity to select, edit, single out, structure, highlight, group, pair, merge, harmonize, synthesize, focus, organize, condense, reduce, boil down, choose, categorize, catalog, classify, list, abstract, scan, look into, idealize, isolate, discriminate, distinguish, screen, pigeonhole, pick over, sort, integrate, blend, inspect, filter, lump, skip, smooth, chunk, average, approximate, cluster, aggregate, outline, summarize, itemize, review, dip into, flip through, browse, glance into, leaf through, skim, refine, enumerate, glean, synopsise, winnow the wheat from the chaff and separate the sheep from the goats.

optima nova / no features

We thrive in information-thick worlds because of our marvelous and everyday capacity to select, edit, single out, structure, highlight, group, pair, merge, harmonize, synthesize, focus, organize, condense, reduce, boil down, choose, categorize, catalog, classify, list, abstract, scan, look into, idealize, isolate, discriminate, distinguish, screen, pigeonhole, pick over, sort, integrate, blend, inspect, filter, lump, skip, smooth, chunk, average, approximate, cluster, aggregate, outline, summarize, itemize, review, dip into, flip through, browse, glance into, leaf through, skim, refine, enumerate, glean, synopsise, winnow the wheat from the chaff and separate the sheep from the goats.

optima nova / default features

Figure 8.16 Pagella (OPENTYPE) and Optima Nova (TYPE1)

Abracadabra

8.8 Transparency groups

The following feature is not that useful but implemented anyway. The PDF reference says:

- A group may be isolated or non-isolated, which shall determine the initial backdrop against which its stack is composited.
- A group may be knockout or non-knockout, which shall determine whether the objects within its stack are composited with one another or only with the group's backdrop.

and then carries on with a detailed explanation of groups. Here we stick to just mentioning how one can create a group in a picture. First we define a helper:

```
\startMPdefinitions
  def ShowGroup (expr clr) (text grouped) =
    draw image (
      drawarrow (10,0) -- (0,0)
        withtransparency(1,.5)
        withcolor clr ;
    ) grouped ;
    currentpicture := currentpicture x sized (TextWidth/8) ;
    setbounds currentpicture to boundingbox currentpicture enlarged 2mm ;
    addbackground withcolor .5white ;
  enddef ;
\stopMPdefinitions
```

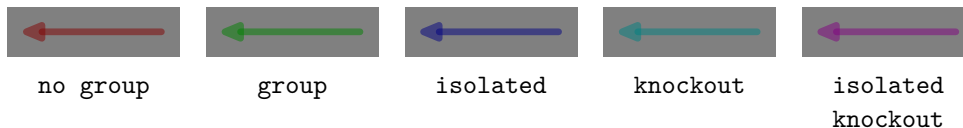

The syntax is:

```
draw somepicture|somepath grouped "[isolated|knockout] ;
```

The group becomes an object and is no longer part of the stream of graphic operators but a reference. For what it's worth: I never needed this feature.

8.9 Decorating

Although the METAPost language is quite powerful the number of data types is not that large and when it comes to drawing stuff there are only paths and pictures. A path is a list of points (with controlpoints) and a few properties, like the pen, linewidth, linecap, color and such. For a long time in METAFUN we used so called specials to implement extensions (like shading). This was done by using special colors and associating these with entries in the special section at the top of the output.

Nowadays we use the pre- and postscript properties of paths. The advantage is that we can add whatever we want, as long as the backend supports it and because the backend is written in LUA there are no real limitations. So, instead of extending METAPost we extend the METAFUN macros and backend.

Most extensions use the prescripts. Think of this:

```
draw fullcircle
  withprescript "do this"
  withprescript "and that"
```



```
withprescript "and even more" ;
```

Eventually this becomes a string:

```
and even more<newline>and that<newline>do this
```

```
\startMPdefinitions
def ShowGroup (expr clr) (text grouped) =
  draw image (
    drawarrow (10,0) -- (0,0)
      withtransparency(1,.5)
      withcolor clr ;
  ) grouped ;
  currentpicture := currentpicture xscaled (TextWidth/8) ;
  setbounds currentpicture to boundingbox currentpicture enlarged 2mm ;
  addbackground withcolor .5white ;
enddef ;
\stopMPdefinitions
```

The prescripts get prepended, while the postscripts (that we use for text only) get appended. When we draw a picture with properties (like color) they get overwritten but not so (with good reason) for the pre- and postscripts: these just accumulate. We will now demonstrate how we can manipulate the picture (a bit).

```
picture MyShape ; MyShape := image (
  fill fullsquare xyscaled (4,1) withcolor .625red ;
  fill fullsquare xyscaled (3,1) withcolor .625green ;
  fill fullsquare xyscaled (2,1) withcolor .625blue ;
  fill fullsquare xyscaled (1,1) withcolor .625yellow ;
) xysized (TextWidth,1cm) ;

draw MyShape;
```

We just draw the (natural) picture:



When we draw the picture with a new color, all its components get recolored:

```
draw MyShape
withcolor .625magenta ;
```



However, when we add a transparency only the first component gets adapted because we use prescripts for this extension. (An extension using the postscripts would affect the last component.)

```
draw MyShape
withcolor .625magenta
withtransparency (1,.5) ;
```



The same logic applied to the image: prescripts get prepended to the first component, postscripts to the last.

```
draw image (draw MyShape)
  withcolor .625cyan ;
```



```
draw image (draw MyShape)
  withcolor .625cyan
  withtransparency (1,.5) ;
```



The undecorated macro ignores the properties. We can't reset the scripts as this could ruin the effects like shading.

```
draw undecorated (draw MyShape)
  withcolor .625white ;
```



The decorated macro applies the properties to each component.

```
draw decorated (draw MyShape)
  withtransparency (1,.5) ;
```



Here we kept the colors as they are but next we redo them:

```
draw decorated (draw MyShape)
  withcolor .625magenta
  withtransparency (1,.5) ;
```



The redecorated macro is the most intrusive as it resets the properties. This also means that you will lose texts, shades etc.

```
draw redecorated (draw MyShape)
  withtransparency (1,.5) ;
```



Indeed we get no color (but black) but we can bring back some color:

```
draw redecorated (draw MyShape)
  withcolor .625yellow
  withtransparency (1,.5) ;
```



8.10 Properties

The (plain) METAPOST macro `drawoptions` stored its arguments in a macro that gets expanded when something is drawn (or filled). So, when you say

```
drawoptions(withcolor red) ;
draw somepath ;
```

This effectively is:

```
draw somepath withcolor red ;
```

A disadvantage is that there is not much control over where it gets applied, especially when you hide drawing operations in macros. It's the reason why personally I always prefer explicit options. If you want some abstraction you can use the properties feature:

```
\startMPcode
  property p[] ;
  p1 = properties(withcolor "darkred") ;
  p2 = properties(withcolor "darkblue") ;
  p3 = properties(withcolor "darkgreen") ;
  fill fullsquare xysized (TextWidth,12mm) withproperties p1 ;
  fill fullsquare xysized (TextWidth, 8mm) withproperties p2 ;
  fill fullsquare xysized (TextWidth, 4mm) withproperties p3 ;
  fill fullsquare xysized (TextWidth, 2mm) withproperties p1 ;
\stopMPcode
```

We get:



Here we use an 'array' of properties but a single property is also possible:

```
\startMPcode
  property p ;
  p = properties(withcolor "darkyellow") ;
  fill fullsquare xysized (TextWidth,4mm) withproperties p ;
\stopMPcode
```

We get:



9 Functions

METAPOST provides a wide range of functions, like `sind` and `floor`. We will discuss most of them here and define a few more. We will also introduce a few methods for drawing grids and functions.

9.1 Overview

What follows is a short overview of the functions that can be applied to numeric expressions and strings. Functions that operate on pairs, colors, paths and pictures are discussed in other chapters.

First of all we have `+`, `-`, `/` and `*`. For as far as is reasonable, you can apply these to numerics, pairs and colors. Strings can be concatenated by `&`.

Pythagorean addition is accomplished by `++`, while Pythagorean subtraction is handled by `--`. The `**` operator gives you exponentiation. The nature of the METAPOST language is such that you can easily define interesting functions using such symbols.

The logarithmic functions are based on bytes. This makes them quite accurate but forces you to think like a computer.

<code>mexp(x)</code>	exponential function with base 256
<code>mlog(x)</code>	logarithm with base 256

The basic goniometric functions operate on degrees, which is why they have a 'd' in their name.

<code>cosd(x)</code>	cosine of x with x in degrees
<code>sind(x)</code>	sine of x with x in degrees

There are three ways to truncate numbers. The `round` function can also handle pairs and colors.

<code>ceiling(x)</code>	the least integer greater than or equal to x
<code>floor(x)</code>	the greatest integer less than or equal to x
<code>round(x)</code>	round each component of x to the nearest integer

Of course we have:

<code>x mod y</code>	the remainder of x/y
<code>x div y</code>	the integer part of x/y
<code>abs(x)</code>	the absolute value of x
<code>sqrt(x)</code>	the square root of x
<code>x dotprod y</code>	the dot product of two vectors

What would life be without a certain randomness and uncertainty:

<code>normaldeviate</code>	a number with mean 0 and standard deviation 1
<code>uniformdeviate(x)</code>	a number between zero and x

The following functions are actually macros:

<code>decr(x,n)</code>	decrement x by n
<code>incr(x,n)</code>	increment x by n

`max(a,b,...)` return the maximum value in the list
`min(a,b,...)` return the minimum value in the list

The `min` and `max` functions can be applied to numerics as well as strings.

The following functions are related to strings:

<code>oct s</code>	string representation of an octal number
<code>hex s</code>	string representation of a hexadecimal number
<code>str s</code>	string representation for a suffix
<code>ASCII s</code>	ASCII value of the first character
<code>char x</code>	character of the given ASCII code
<code>decimal x</code>	decimal representation of a numeric

With `substring (i,j)` of `s` you can filter the substring bounded by the given indices from the given string.

In METAFUN we provide a few more functions (you can take a look in `mp-tool.mp` to see how they are defined. You need to be aware of very subtle rounding errors. Normally these only show up when you reverse an operation. This is a result from mapping to and from internal quantities.

<code>sqr(x)</code>	x^2
<code>log(x)</code>	$\log(x)$
<code>ln(x)</code>	$\ln(x)$
<code>exp(x)</code>	e^x
<code>pow(x, p)</code>	x^p
<code>inv(x)</code>	$1/x$

The following sine and cosine functions take radians instead of angles in degrees.

<code>sin(x)</code>	<code>asin(x)</code>	<code>invsin(x)</code>
<code>cos(x)</code>	<code>acos(x)</code>	<code>invcos(x)</code>

There are no tangent functions, so we provide both the radian and degrees versions:

<code>tan(x)</code>	<code>tand(x)</code>
<code>cot(x)</code>	<code>cotd(x)</code>

Here are a couple of hyperbolic functions.

<code>sinh(x)</code>	<code>asinh(x)</code>
<code>cosh(x)</code>	<code>acosh(x)</code>

We end with a few additional string converters.

<code>ddecimal x</code>	decimal representation of a pair
<code>ddecimal x</code>	decimal representation of a color
<code>condition x</code>	string representation of a boolean

9.2 Grids

Some day you may want to use METAPOST to draw a function like graphic. In the regular \TeX distributions you will find a module `graph.mp` that provides many ways to accomplish this. For the

moment, METAFUN does not provide advanced features with respect to drawing functions, so this section will be relatively short.

When drawing a functions (for educational purposes) we need to draw a couple of axis or a grid as well as a shape. Along the axis we can put labels. For this we can use the METAPOST package format .mp, but this does not integrate that well into the way METAFUN deals with text typeset by \TeX .

For those who love dirty tricks and clever macros, close reading of the code in format .mp may be worthwhile. The format macros in there use \TeX to typeset the core components of a number, and use the dimensions of those components to compose combinations of signs, numbers and superscripts.

In METAFUN we have the module mp-form.mp which contains most of the code in format .mp but in a form that is a bit more suited for fine tuning. This permits us to use either the composition method, or to fall back on the texttext method that is part of METAFUN. That way we can also handle fonts that have digits with different dimensions. Another ‘change’ concerns the pattern separator. Instead of a % we use @; you can choose to set another separator, but for embedded definitions % is definitely a bad choice because \TeX sees it as a comment and ignores everything following it.

```
drawoptions(withpen pencircle scaled 1pt withcolor .625yellow) ;
draw hlingrid(0, 10, 1, 3cm, 3cm) ;
draw vlingrid(0, 10, 1, 3cm, 3cm) ;

draw hlingrid(0, 10, 1, 3cm, 3cm) shifted ( 3.5cm,0) ;
draw vloggrid(0, 10, 1, 3cm, 3cm) shifted ( 3.5cm,0) ;

draw hloggrid(0, 10, 1, 3cm, 3cm) shifted ( 7.0cm,0) ;
draw vlingrid(0, 10, 1, 3cm, 3cm) shifted ( 7.0cm,0) ;

draw hloggrid(0, 10, 1, 3cm, 3cm) shifted (10.5cm,0) ;
draw vloggrid(0, 10, 1, 3cm, 3cm) shifted (10.5cm,0) ;
```

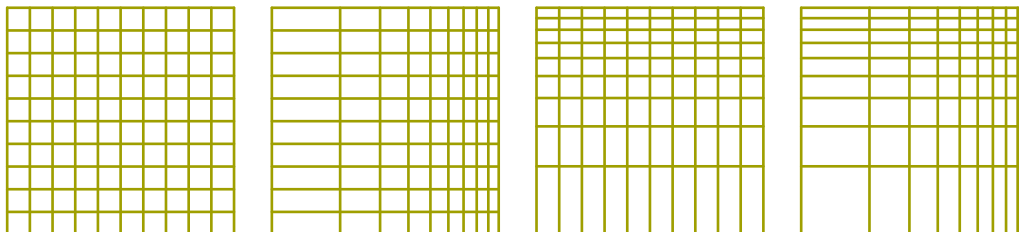

```
drawoptions(withpen pencircle scaled 1pt withcolor .625yellow) ;
draw hlingrid(0, 10, 1, 3cm, 3cm) slanted .5 ;
draw vlingrid(0, 10, 1, 3cm, 3cm) slanted .5 ;
```

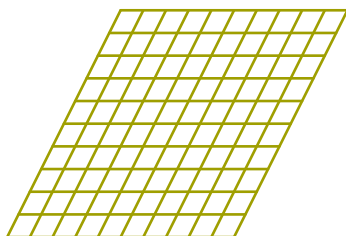

Using macros like these often involves a bit of trial and error. The arguments to these macros are as follows:

```
hlingrid (Min, Max, Step, Length, Width)
vlingrid (Min, Max, Step, Length, Height)
hloggrid (Min, Max, Step, Length, Width)
vloggrid (Min, Max, Step, Length, Height)
```

The macros take the following text up to the semi-colon into account and return a picture. We will now apply this knowledge to a more meaningful example. First we draw a grid.

You can use the grid drawing macros to produce your own paper, for instance using the following mixed \TeX - \METAPOST code:

```
\startMPpage
  StartPage ;
  width := PaperWidth ; height := PaperHeight ; unit := cm ;
  drawoptions(withpen pencircle scaled .2pt withcolor .8white) ;
  draw vlingrid(0, width /unit, 1/10, width, height) ;
  draw hlingrid(0, height/unit, 1/10, height, width) ;
  drawoptions(withpen pencircle scaled .5pt withcolor .4white) ;
  draw vlingrid(0, width /unit, 1, width, height) ;
  draw hlingrid(0, height/unit, 1, height, width) ;
  StopPage ;
\stopMPpage
```

This produces a page (as in figure 9.1) with a metric grid. If you're hooked to the inch, you can set `unit := 1in`. If you want to process this code, you need to wrap it into the normal document producing commands:

```
\setupcolors[state=start]
\starttext
  ... definitions ...
\stoptext
```

9.3 Drawing functions

Today there are powerful tools to draw functions on grids, but for simple functions you can comfortably use \METAPOST . Let's first draw a simple log-linear grid.

```
drawoptions(withpen pencircle scaled .25pt withcolor .5white) ;
draw hlingrid (0, 20, .2, 20cm, 10cm) ;
draw vloggrid (0, 10, .5, 10cm, 20cm) ;
drawoptions(withpen pencircle scaled .50pt) ;
draw hlingrid (0, 20, 1, 20cm, 10cm) ;
draw vloggrid (0, 10, 1, 10cm, 20cm) ;
```

To this grid we add some labels:

```
fnt_pictures := false ; % use TeX as formatting engine
```

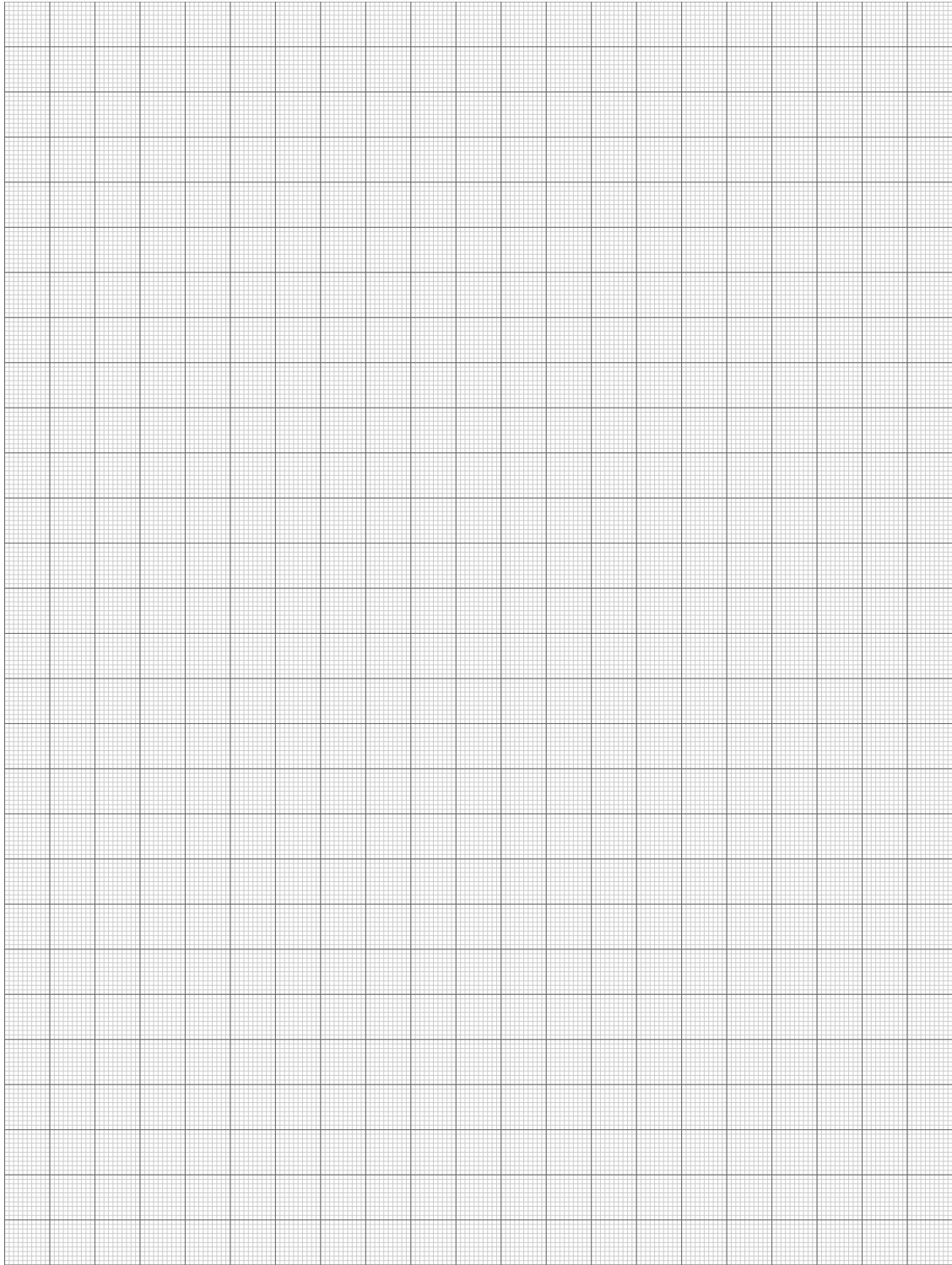



Figure 9.1 Quick and dirty grid paper.

```

textxoffset := ExHeight ; % a variable set by ConTeXt

draw hlinext.lft(0, 20, 5, 20cm, "@3e") ;
draw vlogtext.bot(0, 10, 9, 10cm, "@3e") ;

```

The arguments to the text placement macros are similar to the ones for drawing the axes. Here we provide a format string.

```

hlinext (Min, Max, Step, Length, Format)
vlinext (Min, Max, Step, Length, Format)
hlogtext (Min, Max, Step, Length, Format)
vlogtext (Min, Max, Step, Length, Format)

```

When drawing a smooth function related curve, you need to provide enough sample points. The function macro will generate them for you, but you need to make sure that for instance the maximum and minimum values are part of the generated series of points. Also, a smooth curve is not always the right curve. Therefore we provide three drawing modes:

method	result
1	a punked curve, drawn using --
2	a smooth curve, drawn using ..
3	a tight curve, drawn using ...

If method 2 or 3 do not give the desired outcome, you can try a smaller step combined with method 1.

```

draw
  function(1,"log(x)","x",1,10,1) xyscaled (10cm,2cm)
  withpen pencircle scaled 5mm withcolor transparent(1,.5,yellow) ;

draw
  function(2, ".5log(x)","x",1,10,1) xyscaled (10cm,2cm)
  withpen pencircle scaled 5mm withcolor transparent(1,.5,blue) ;

```

The first argument to the function macro specifies the drawing method. The last three arguments are the start value, end value and step. The second and third argument specify the function to be drawn. In this case the pairs (x, x) and $(.5\log(x), x)$ are calculated.

```

textxoffset := ExHeight ;

drawoptions(withpen pencircle scaled .50pt) ;

draw hlingrid(-10, 10, 1, 10cm, 10cm) ;
draw vlingrid( 0, 20, 1, 10cm, 20cm) shifted (0,-10cm) ;

drawoptions() ;

draw
  function(2,"x","sind(x)",0,360,10) xyscaled (1cm/36,10cm)
  withpen pencircle scaled 5mm withcolor transparent(1,.5,blue) ;

draw
  function(2,"x","sin(x*pi)",0,epsed(2),.1) xyscaled (10cm/2,5cm)
  withpen pencircle scaled 5mm withcolor transparent(1,.5,yellow) ;

```

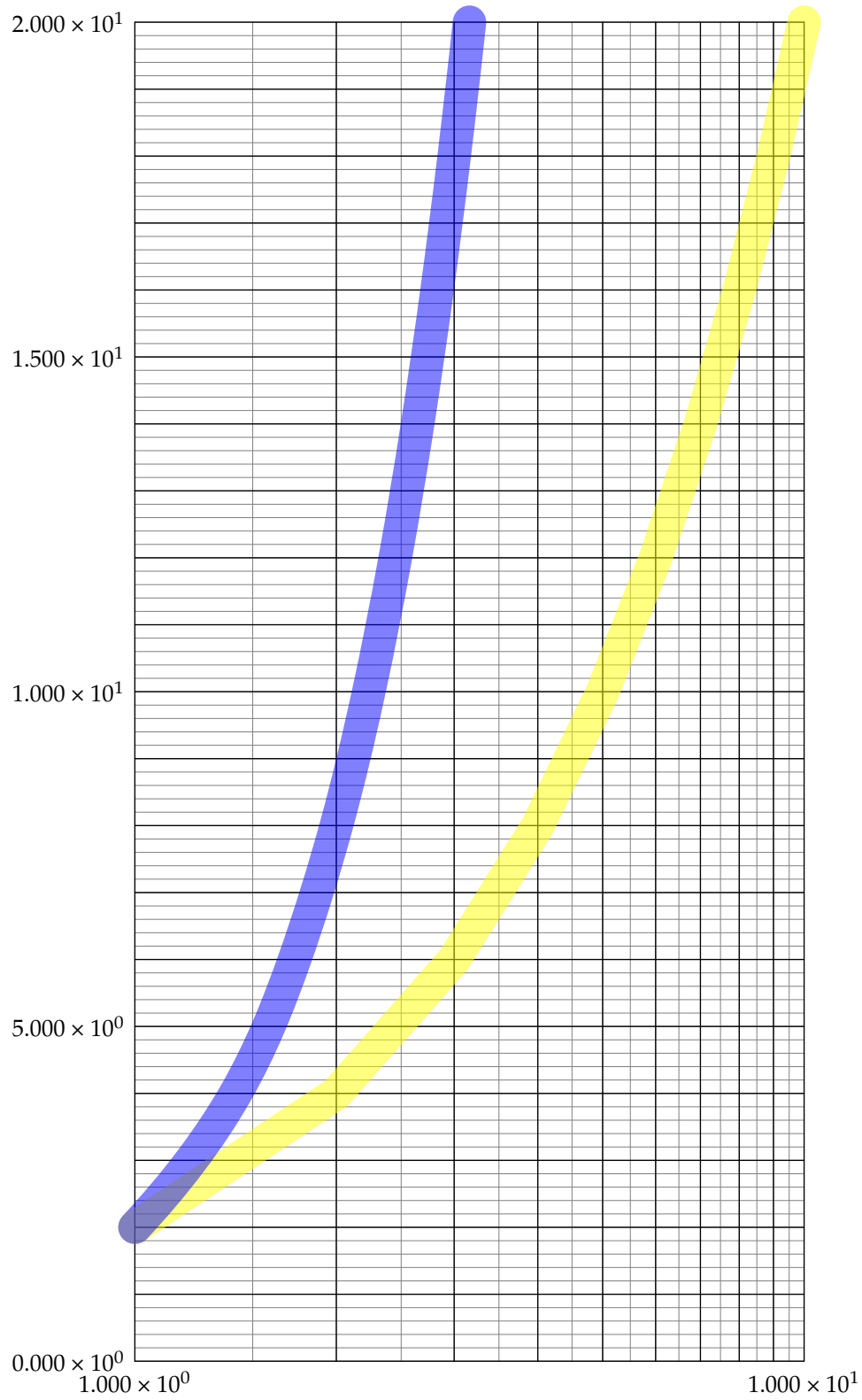

Figure 9.2 An example of a graphic with labels along the axes.

```

draw
  function(2,"x","cosd(x)",0,360,10) xyscaled (1cm/36,10cm)
  withpen pencircle scaled 5mm withcolor transparent(1,.5,red) ;

draw
  function(2,"x","cos(x*pi)",0,epsed(2),.1) xyscaled (10cm/2,5cm)
  withpen pencircle scaled 5mm withcolor transparent(1,.5,green) ;

```

In this example we draw sinus and cosine functions using degrees and radians. In the case of radians the end points are not calculated due to rounding errors. In such case you can use the `epsed` value, which gives slightly more playroom.

```

draw function (1, "x", "sin(2x)"      , 1, 10, .01) scaled 1.5cm
  withpen pencircle scaled 1mm withcolor transparent(1,.5,red) ;
draw function (1, "x", "sin(2x*x)"    , 1, 10, .01) scaled 1.5cm
  withpen pencircle scaled 1mm withcolor transparent(1,.5,green) ;
draw function (1, "x", "sin(2x*x+x)"  , 1, 10, .01) scaled 1.5cm
  withpen pencircle scaled 1mm withcolor transparent(1,.5,blue) ;

```

Of course you can do without a grid. The next example demonstrates a nice application of transparencies.

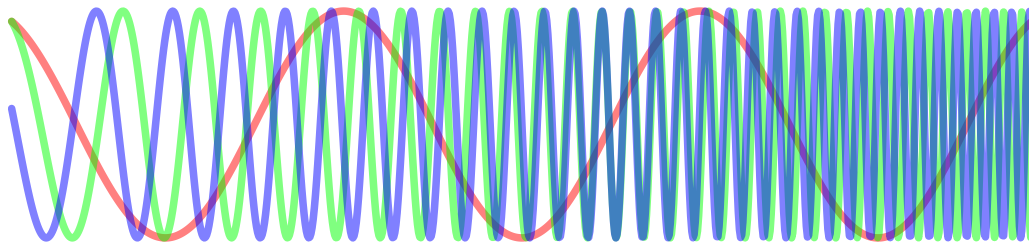

If we use the exclusion method for the transparencies, combined with no transparency, we get the following alternative.

```

draw function (2, "x", "sin(x)"      , 0, 2pi, pi/40) scaled 2cm
  withpen pencircle scaled 5mm withcolor transparent("exclusion",1,red) ;
draw function (2, "x", "sin(2x)"    , 0, 2pi, pi/40) scaled 2cm
  withpen pencircle scaled 5mm withcolor transparent("exclusion",1,green) ;
draw function (2, "x", "sin(3x)"    , 0, 2pi, pi/40) scaled 2cm
  withpen pencircle scaled 5mm withcolor transparent("exclusion",1,blue) ;

```

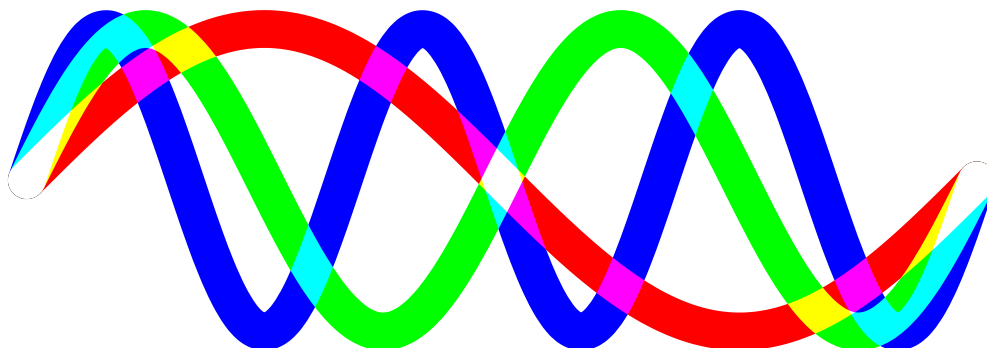

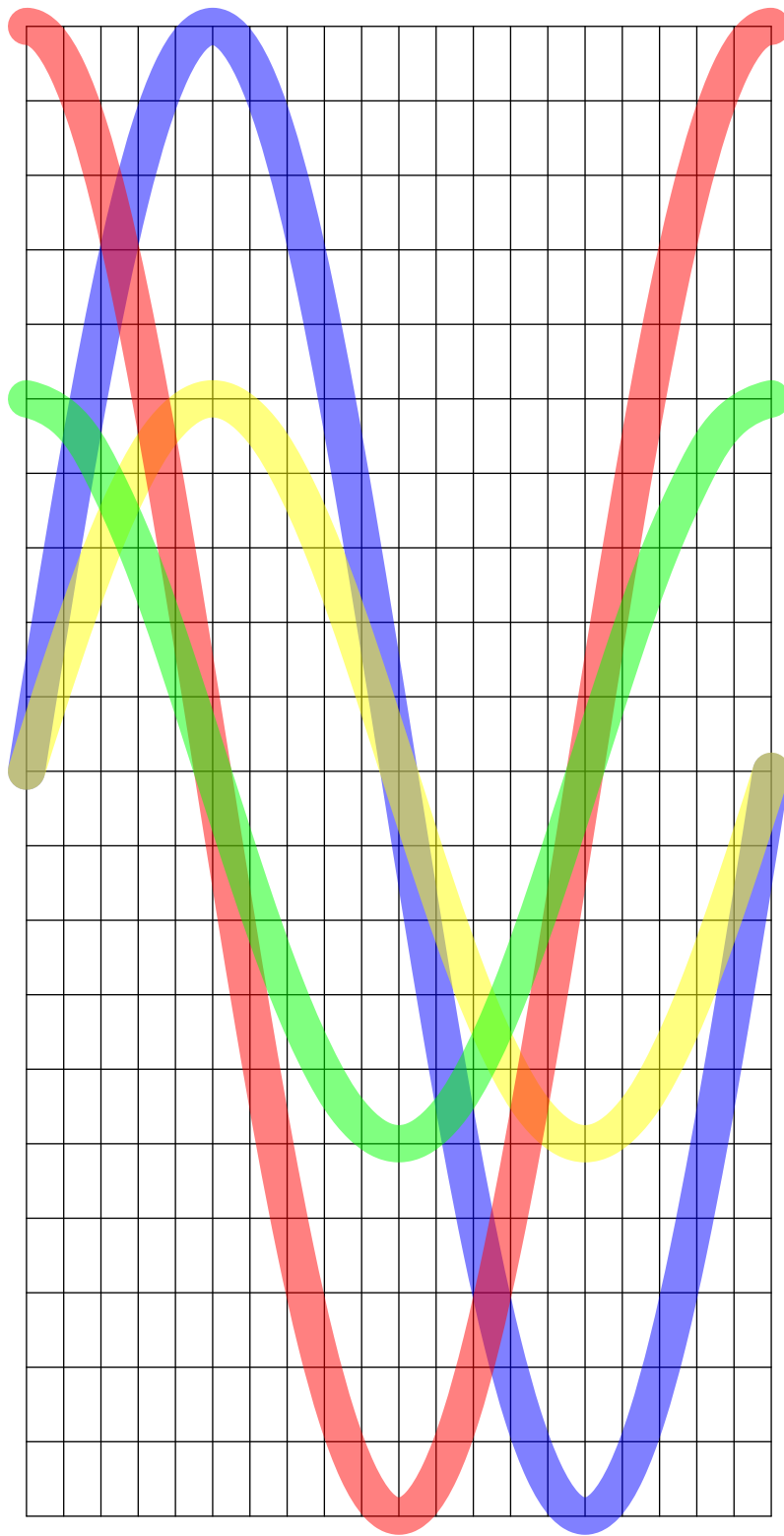
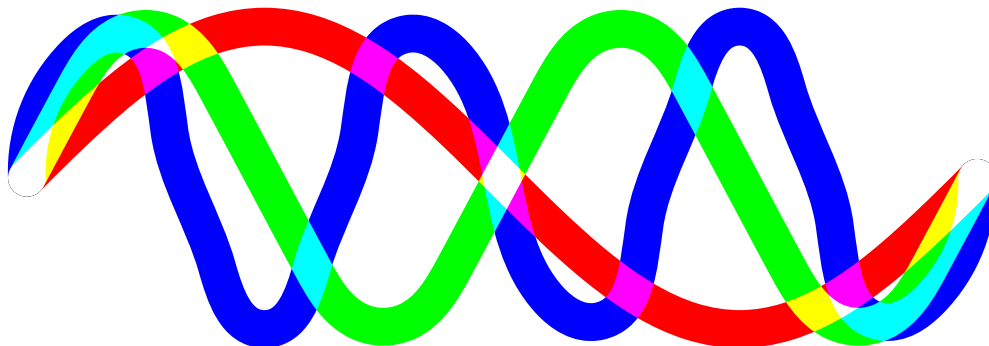

Figure 9.3 By using transparent colors, we don't have to calculate and mark the common points: they already stand out.

The next alternative uses a larger step, and as a result (in drawing mode 2) gives worse results. (Without the `epsed` it would have looked even worse in the end points.

```
draw function (2, "x", "sin(x)", 0, epsed(2pi), pi/10) scaled 2cm
  withpen pencircle scaled 5mm withcolor transparent("exclusion",1,red) ;
draw function (2, "x", "sin(2x)", 0, epsed(2pi), pi/10) scaled 2cm
  withpen pencircle scaled 5mm withcolor transparent("exclusion",1,green) ;
draw function (2, "x", "sin(3x)", 0, epsed(2pi), pi/10) scaled 2cm
  withpen pencircle scaled 5mm withcolor transparent("exclusion",1,blue) ;
```



There are enough applications out there to draw nice functions, like gnuplot for which Mojca Miklavc made a backend that works well with `CONTEX`. Nevertheless it can be illustrative to explore the possibilities of the `CONTEX`, `LUATEX`, `METAPOST` combination using functions.

First of all you can use `LUA` to make paths and this is used in some of the debugging and tracing options that come with `CONTEX`. For instance, if you process a document with

```
context --timing yourdoc.tex
```

then you can afterwards process a file that is generated while processing this document:

```
context --extras timing yourdoc
```

This will give you a document with graphics that show where `LUATEX` spent its time on. Of course these graphics are generated with `METAPOST`.

There are a few helpers built in (and more might follow). For example:

```
draw
  \ctxlua {
    metapost.metafun.topath {
      { x=1, y=1 },
      { x=1, y=3 },
      { 4, 1},
      "cycle"
    }
  }
  xysized(4cm,3cm)
  withpen pencircle scaled 1mm
  withcolor .625 red ;
```

The `topath` function takes a table of points or strings.

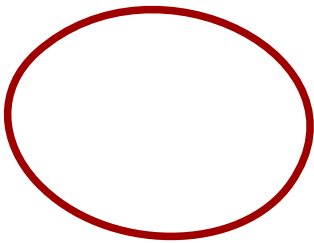

You can pass a connector so

```
draw
  \ctxlua {
    metapost.metafun.topath (
      {
        { x=1, y=1 },
        { x=1, y=3 },
        { 4, 1 },
        "cycle"
      },
      "--"
    )
  }
  xysized(4cm,3cm)
  withpen pencircle scaled 1mm
  withcolor .625 red ;
```

gives:

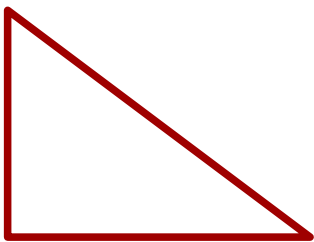

Writing such LUA functions is no big deal. For instance we have available:

```
function metapost.metafun.interpolate(f,b,e,s,c)
  tex.write("(")
  for i=b,e,(e-b)/s do
    local d = loadstring (
      string.formatters["return function(x) return %s end"](f)
    )
    if d then
      d = d()
      if i > b then
        tex.write(c or "...")
      end
      tex.write(string.formatters["(%F,%F)"](i,d(i)))
    end
  end
end
```

```

end
tex.write("")
end

```

An example of usage is:

```

draw
\ctxlua{metapost.metafun.interpolate(
  "math.sin(x^2+2*x+math.sqrt(math.abs(x)))",
  -math.pi/2,math.pi/2,100
)}
xysized(6cm,3cm)
withpen pencircle scaled 1mm
withcolor .625 red ;

```

And indeed we get some drawing:

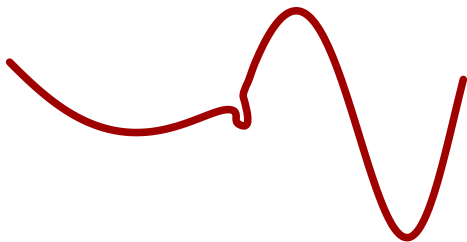

Let's see what happens when we use less accuracy and a different connector:

```

draw
\ctxlua{metapost.metafun.interpolate(
  "math.sin(x^2+2*x+math.sqrt(math.abs(x)))",
  -math.pi/2,math.pi/2,10,"--"
)}
xysized(6cm,3cm)
withpen pencircle scaled 1mm
withcolor .625 red ;

```

Now we get:



Of course we could extend this LUA function with all kind of options and we might even do that when we need it.

10 Typesetting in METAPOST

It is said that a picture tells more than a thousand words. So you might expect that text in graphics becomes superfluous. Out of experience we can tell you that this is not the case. In this chapter we explore the ways to add text to METAPOST graphics, and let you choose whether or not to have it typeset by T_EX.

10.1 The process

You can let METAPOST process text that is typeset by T_EX. Such text is first embedded in the METAPOST file in the following way:

```
btex Some text to be typeset by \TEX etex
```

This returns a picture, but only after METAPOST has made sure that T_EX has converted it into something useful. This process of conversion is slightly system dependent and even a bit obscure. Traditional METAPOST calls a program that filters the `btex...etex` commands, next it calls T_EX by passing the output routine, in order to make sure that each piece of text ends up on its own page, and afterwards it again calls a program that converts the DVI pages into METAPOST pictures. In L^AT_EX's MPLIB a different route is followed.

In CON_TE_XT MKII, when using WEB2C, you can generate the graphics at run-time. This takes more time than processing the graphics afterwards, but has the advantage that T_EX knows immediately what graphic it is dealing with. When enabled, CON_TE_XT will call either METAPOST, or, when the graphic contains `btex-etex` commands, call T_EXEXEC, which in turn makes sure that the right auxiliary programs are executed.

In CON_TE_XT MKIV you won't notice this at all because everything is tightly integrated with L^AT_EX's MPLIB. This has an enormous speed gain: when this manual had about 425 pages, on my laptop with mobile 3840QM processor, one run of this document takes 18 seconds (14.5 with L^AUJIT_EX) and that includes loadint a bunch of (outline) fonts and processing some 2200 METAPOST images. While writing the first version of this manual runtime was upto 50 times slower for half the number of pages so compared to MKII we have gained a lot.

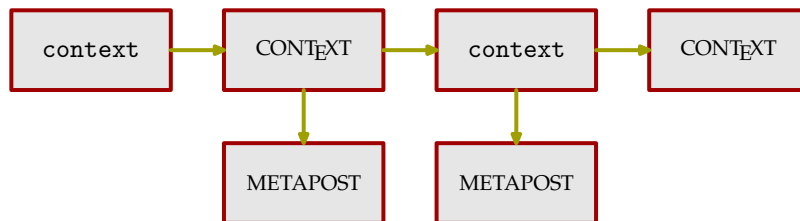

Figure 10.1 How T_EX and METAPOST work together.

10.2 Environments

In case you want to pass code that is shared by all `btex-etex` pictures, METAPOST provides:

```
verbatimtex \DefineSomeCommands etex ;
```

However, in `CONTEXT` one has a better mechanism available. In `CONTEXT MKII` the advised method is passing environments. The best way to pass them is the following. As an example we switch to the 15 basic `POSTSCRIPT` fonts.

```
\startMPenvironment
  \usetypescript[palatino][texnansi] % mkii has encodings
  \setupbodyfont[palatino]
\stopMPenvironment
```

This means that in code like the following, a Palatino font will be used.

```
\startMPcode
draw btex Meta is a female lion! etex
  xysized (\the\textwidth,\the\textheight) ;
\stopMPcode
```

However, in `CONTEXT MKIV` this method is no longer recommended as all processing happens in the same run anyway.

```
\startMPcode
numeric w, h ; w := \the\textwidth ; h := w/2 ;

picture p ; p := btex \colored[r=.375,g=.375]{Meta is a female lion!} etex
  xysized (w,h) ;
picture q ; q := btex \colored[r=.625] {Meta is a female lion!} etex
  xysized (w,h) ;

path b ; b := boundingbox p ; draw p ;
for i=(.28w,.90h),(.85w,.90h),(w,.05h) :
  picture r ; r := q ;
  path s ; s := (fullsquare xscaled .05w yscaled .4h) shifted i ;
  clip r to s ; draw r ; % draw s ;
endfor ;

setbounds currentpicture to b ;
\stopMPcode
```

Figure 10.2 shows the previous sentence in a slightly different look. You may consider coloring the dots to be an exercise in clipping.

An environment can be reset with `\resetMPenvironment` or by passing `reset` to `\startMPenvironment`.

```
\startMPenvironment[reset]
  \usetypescript[postscript][texnansi] % mkii
  \setupbodyfont[postscript]
\stopMPenvironment
```

So, to summarize: if you're using `CONTEXT MKIV` you might as well forget what you just read.

10.3 Labels

In `METAPOST` you can use the `label` macro to position text at certain points.



Figure 10.2 An example of clipping.

```
label("x", origin) ;
```

The font and scale are determined by two variables, `defaultfont` and `defaultscale`, the former expecting the name of a font in the form of a string, the latter expecting a numeric to be used in the scaling of the font. Should you choose not to set these yourself, they default to "Mono" and 1.0, respectively. However, you can change the defaults as follows:

```
defaultfont := "texgyrepagella-regular*default" ;
defaultscale := 1.2 ;
```

These settings selects Pagella at about 12pt. You can also set these variables to $\text{CON}\text{T}\text{E}\text{X}\text{T}$ related values. For $\text{CON}\text{T}\text{E}\text{X}\text{T}$ graphics they are set to:

```
defaultfont := "\truefontname{Regular}*default" ;
defaultscale := \the\bodyfontsize/10 ;
```

This means that they will adapt themselves to the current body font (in this document we get file:texgyrepagella-regular) and the current size of the bodyfont (here 10.0pt/10).

10.4 TEX text

In the next example we will use a special mechanism for building graphics step by step. The advantage of this method is that we can do intermediate calculations in TEX . Our objective is to write a macro that draws text along a circular path. While doing so we want to achieve the following:

- the text should be properly kerned, i.e. the spacing between characters should be optimal,
- the position on the circle should vary, and
- the radius of the circle should vary.

This implementation is not the most straightforward one, but by doing it step by step, at least we see what is involved. Later, we will see a better method. If you run these examples yourself, you must make sure that the TEX environment of your document matches the one used by $\text{M}\text{E}\text{T}\text{A}\text{P}\text{O}\text{S}\text{T}$.

We let the `bodyfont` match the font used in this document, and define `RotFont` to be the regular typeface, the one you are reading right now, but bold.

```
\definefont [RotFont] [RegularBold*default]
```

Since METAPOST is unaware of kerning, we have to use \TeX to keep track of the positions. We will split the text into tokens (often characters) and store the result in an array of pictures (`pic`). We will also store the accumulated width in an array (`len`). The number of characters is stored in `n`. In a few paragraphs we will see why the other arrays are needed.

While defining the graphic, we need \TeX to do some calculations. Therefore, we will use `\startMPdrawing` to stepwise construct the definition. The basic pattern we will follow is:

```
\resetMPdrawing
\startMPdrawing
  metapost code
\stopMPdrawing
tex code
\startMPdrawing
  metapost code
\stopMPdrawing
\MPdrawingdonetrue
\getMPdrawing
```

In the process, we will use a few variables. We will store the individual characters of the text in the variable `pic`, its width in `wid` and the length of the string so far in `len`. Later we will use the `pos` array to store the position where a character ends up. The variable `n` holds the number of tokens.

```
\resetMPdrawing
\startMPdrawing
  picture pic[] ;
  numeric wid[], len[], pos[], n ;
  wid[0] := len[0] := pos[0] := n := 0 ;
\stopMPdrawing
```

We also started fresh by resetting the drawing. From now on, each start command will add some more to this graphic. The next macro is responsible for collecting the data. Each element is passed on to \TeX , using the `btex` construct. So, METAPOST itself will call \TeX !

```
\def\whatever#1%
  {\appendtoks#1\to\MPtoks
  \setbox\MPbox=\hbox{\bfd\the\MPtoks}%
  \startMPdrawing
    n := n + 1 ; len[n] := \the\wd\MPbox ;
  \stopMPdrawing
  \startMPdrawing[-]
    pic[n] := textext("\bfd\setstrut\strut#1") ;
    pic[n] := pic[n] shifted - llcorner pic[n] ;
  \stopMPdrawing}

\handletokens MetaPost is Fun!\with\whatever
```

We use the low level `CONTEXT` macro `\appendtoks` to extend the token list `\MPtoks`. The `\handletokens` macro passes each token (character) of `MetaPost is Fun!` to the macro `\whatever`. The tokens are appended to the token register `\MPtoks` (already defined). Then we typeset the content of `\MPtoks` in `\MPbox` (also already defined). The width of the box is passed to `METAPOST` and stored in `len`.

By default the content of the drawing is expanded, which means that the macro is replaced by its current meaning, so the current width ends up in the `METAPOST` file. The next part of the drawing, starting with `btex`, puts the token in a picture. This time we don't expand the drawing, since we want to pass font information. Here, the `[-]` suppresses expansion of `btex \bfd #1 etex`. The process is iterated by `\handletokens` for each character of the text `MetaPost is Fun!`.

Before we typeset the text, now available in pieces in `pic`, in a circle, we will first demonstrate what they look like. You may like to take a look at the file `mpgraph.mp` to see what is passed to `METAPOST`.

```
\startMPdrawing
  pair len ; len := origin ;
  for i=1 upto n :
    draw pic[i] shifted len ;
    draw boundingbox pic[i] shifted len
      withpen pencircle scaled .25pt withcolor red ;
    len := len+(xpart urcorner pic[i]-xpart llcorner pic[i],0) ;
  endfor ;
\stopMPdrawing
```

We can call up this drawing with `\getMPdrawing`, but first we inform the compiler that our `METAPOST` drawing is completed.

```
\MPdrawingdonetrue\getMPdrawing
```

This results in:



Compare this text with the text as typeset by `TEX`:

MetaPost is Fun!

and you will see that the text produced by `METAPOST` is not properly kerned. When putting characters after each other, `TEX` uses the information available in the font, to optimize the spacing between characters, while `METAPOST` looks at characters as separate entities. But, since we have stored the optimal spacing in `len`, we can let `METAPOST` do a better job. Let's first calculate the correction needed.

```
\startMPdrawing
  for i=1 upto n :
    wid[i] := abs(xpart urcorner pic[i] - xpart llcorner pic[i]) ;
    pos[i] := len[i]-wid[i] ;
  endfor ;
\stopMPdrawing
```

This compares well to the text as typeset by \TeX :

MetaPost is Fun!

We can now use the values in `pos` to position the pictures according to what \TeX considered to be the best (relative) position.

```
\startMPdrawing
  for i=1 upto n :
    draw pic[i] shifted (pos[i],0) ;
    draw boundingbox pic[i] shifted (pos[i],0)
      withpen pencircle scaled .25pt withcolor red ;
  endfor ;
\stopMPdrawing
```

That this correction is adequate, is demonstrated in the next graphic. If you look closely, you will see that for instance the ‘o’ is moved to the left, under the capital ‘P’.

MetaPost is Fun!

When we want to position the pictures along a circle, we need to apply some rotations, especially because we want to go clockwise. Since we don’t want to use ‘complicated’ math or more advanced METAPOST code yet, we will do it in steps.

```
\startMPdrawing
  for i=1 upto n:
    pic[i] := pic[i] rotatedaround(origin,-270) ;
  endfor ;
\stopMPdrawing
```

We will now center the pictures around the baseline. Centering comes down to shifting over half the height of the picture. This can be expressed by:

```
ypart -.5[ulcorner pic[i],llcorner pic[i]]
```

but different ways of calculating the distance are possible too.

```
\startMPdrawing
  for i=1 upto n :
    pic[i] := pic[i]
      shifted (0,ypart -.5[ulcorner pic[i],llcorner pic[i]]) ;
  endfor ;
\stopMPdrawing
```

So, now we have:

When we typeset on a (half) circle, we should map the actual length onto a partial circle. We denote the radius with an r and shift the pictures to the left.

```
\startMPdrawing
  numeric r ; r := len[n]/pi ;
  for i=1 upto n :
    pic[i] := pic[i] shifted (-r,0) ;
  endfor ;
\stopMPdrawing
```

You can now use the following code to test the current state of the pictures. Of course this code should not end up in the final definitions.

```
\startMPdrawing
  draw origin
  withpen pencircle scaled 5pt withcolor red ;
  for i=1 upto n :
    draw pic[i] ;
    draw boundingbox pic[i]
    withpen pencircle scaled .25pt withcolor red ;
  endfor ;
\stopMPdrawing
```



Later we will write a compact, efficient macro to take care of rotation. However, for the moment, so as not to overwhelm you with complicated code, we will rotate each individual picture with the following code fragment.

```
\startMPdrawing
  numeric delta, extra, radius, rot[] ;
  delta := extra := radius := 0 ;
  for i=1 upto n :
    rot[i] := extra+delta-((pos[i]+.5wid[i])/len[n])*180 ;
  endfor ;
\stopMPdrawing
```

Here we introduce a few variables that we can use later to tune the result a bit. With δ , the space between the characters can be increased, while extra rotates the whole string around the origin. The radius variable can be used to increase the distance to the origin. Without these variables, the assignment would have been:

```
rot[i] := ((pos[i]+.5wid[i])/len[n])*180 ;
```

Placing the pictures is now rather easy:

```
\startMPdrawing
  for i=1 upto n :
    draw pic[i] shifted (-radius,0) rotatedaround(origin,rot[i]) ;
  endfor ;
\stopMPdrawing
```

The pictures are now positioned on half a circle, properly kerned.



A bit more insight is given in the next picture:

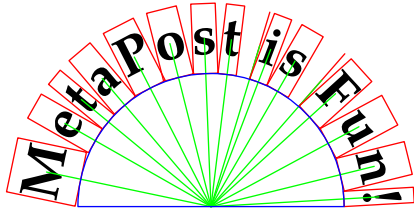

This was defined as follows. The path variable `tcycle` is predefined to the top half of a fullcircle.

```
\startMPdrawing
  def moved(expr i) =
    shifted (-radius,0) rotatedaround(origin,rot[i])
  enddef ;
  pickup pencircle scaled .5pt ;
  for i=1 upto n :
    draw pic[i] moved(i) ;
    draw boundingbox pic[i] moved(i) withcolor red ;
    draw origin -- center pic[i] moved(i) withcolor green ;
  endfor ;
  draw tcircle scaled 2r withcolor blue ;
\stopMPdrawing
```

We will now package all of this into a nice, efficient macro, using, of course, the predefined scratch registers `\MPtoks` and `\MPbox`. First we define the token processor. Note again the expansion inhibition switch `[-]`.

```
\def\processrotationtoken#1%
  {\appendtoks#1\to\MPtoks
  \setbox\MPbox=\hbox{\RotFont\the\MPtoks}%
  \startMPdrawing
  n := n + 1 ; len[n] := \the\wd\MPbox ;
  \stopMPdrawing
  \startMPdrawing[-]
  pic[n] := textext("\RotFont\setstrut\strut#1") ;
  pic[n] := pic[n] shifted - llcorner pic[n] ;
  \stopMPdrawing}
```

The main macro is a bit more complicated but by using a few scratch numerics, we can keep it readable.

```
\def\rotatetokens#1#2#3#4% delta extra radius tokens
```



```

{\vbox\bgroup
  \MPToks\emptytoks
  \resetMPdrawing
  \startMPdrawing
    picture pic[] ;
    numeric wid, len[], rot ;
    numeric delta, extra, radius, n, r ;
    len[0] := n := 0 ;
    delta := #1 ; extra := #2 ; radius := #3 ;
  \stopMPdrawing
  \handletokens#4\with\processrotationtoken
  \startMPdrawing
    r := len[n]/pi ;
    for i=1 upto n :
      wid := abs(xpart lrcorner pic[i] -
                xpart llcorner pic[i]) ;
      rot := extra + delta -
            ((len[i]-.5wid)/len[n]) * (180+2delta) ;
      draw pic[i]
        rotatedaround (origin,-270) shifted (-r-radius,
        ypart -.5[ulcorner pic[i], llcorner pic[i]])
        rotatedaround (origin,rot) ;
    endfor ;
  \stopMPdrawing
  \MPdrawingdonetrue
  \getMPdrawing
  \resetMPdrawing
  \egroup}

```

We can use this macro as follows:

```

\startcombination[3*1]
  {\rotatetokens {0} {0}{0}{Does it work ok?}} {A}
  {\rotatetokens{20} {0}{0}{Does it work ok?}} {B}
  {\rotatetokens{20}{30}{0}{Does it work ok?}} {C}
\stopcombination

```

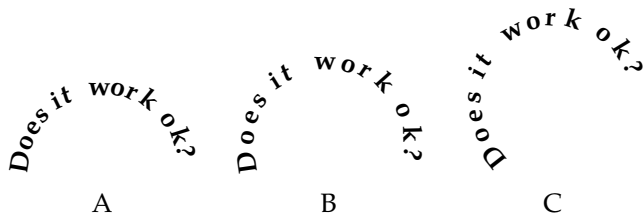

The previous macro is not really an example of generalization, but we used it for demonstrating how to build graphics in a stepwise way. If you put the steps in buffers, you can even combine steps and replace them at will. This is how we made the previous step by step examples: We put each sub-graphic in a buffer and then called the ones we wanted.

We now present a more general approach to typesetting along a given path. This method is not only more robust and general, it is also a more compact definition, especially if we omit the tracing

and testing code. We use a familiar auxiliary definition. The `\setstrut` and `\strut` commands ensure that the lines have the proper depth and height.

```
\def\processfollowingtoken#1%
  {\appendtoks#1\to\MPtoks
   \setbox\MPbox=\hbox{\RotFont\setstrut\strut\the\MPtoks}%
   \startMPdrawing
    n := n + 1 ; len[n] := \the\wd\MPbox ;
   \stopMPdrawing
   \startMPdrawing[-]
    pic[n] := btex \RotFont\setstrut\strut#1 etex ;
    pic[n] := pic[n] shifted -llcorner pic[n] ;
   \stopMPdrawing}
```

In MKII the previous code is collected in the macro `\followtokens` but in MKIV we use a different approach. There we use a mix of \TeX , METAPOST, and LUA to define that macro. The principles remain the same but the code is more robust.

So, how does this compare to earlier results? The original, full text as typeset by \TeX , looks like:

We now follow some arbitrary path ...

In the examples, the text is typeset along the path with:

```
\followtokens{We now follow some arbitrary path ...}
```

We now follow some arbitrary path ...

Since we did not set a path, a dummy path is used. We can provide a path by (re)defining the graphic `followtokens`.

```
\startuseMPgraphic{followtokens}
  path RotPath ; RotPath := fullcircle ;
\stopuseMPgraphic
```

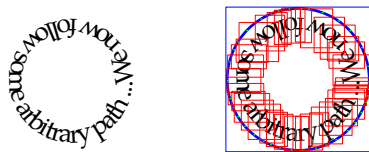

```
\startuseMPgraphic{followtokens}
  path RotPath ; RotPath := reverse fullcircle ;
\stopuseMPgraphic
```

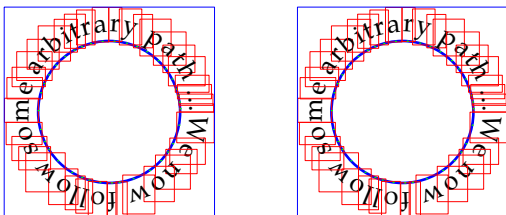

```
\startuseMPgraphic{followtokens}
  path RotPath ; RotPath := (-3cm,-1cm)--(0,1cm)--(3cm,-1cm) ;
```

```
\stopuseMPgraphic
```

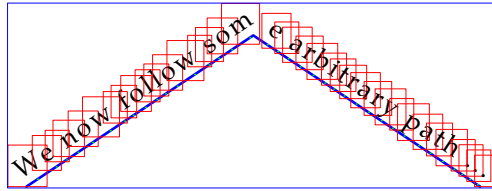
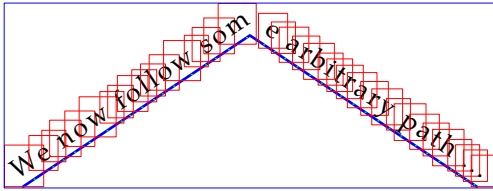

```
\startuseMPgraphic{followtokens}
  path RotPath ; RotPath := (-3cm,0)--(3cm,1cm) ;
\stopuseMPgraphic
```

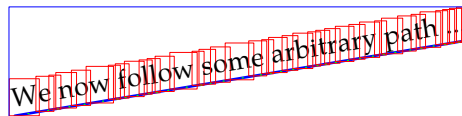
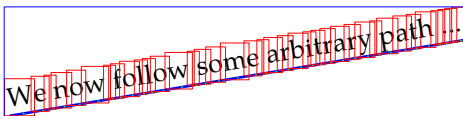

```
\startuseMPgraphic{followtokens}
  path RotPath ; RotPath := (-3cm,0)..(-1cm,1cm)..(3cm,0) ;
\stopuseMPgraphic
```

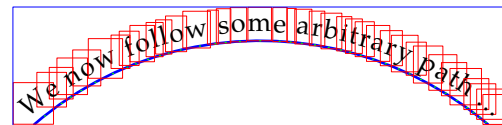
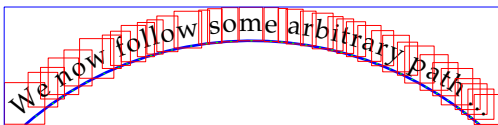

```
\startuseMPgraphic{followtokens}
  path RotPath ; RotPath := (-3cm,0)..(-1cm,1cm)..(0cm,-2cm)..(3cm,0) ;
\stopuseMPgraphic
```

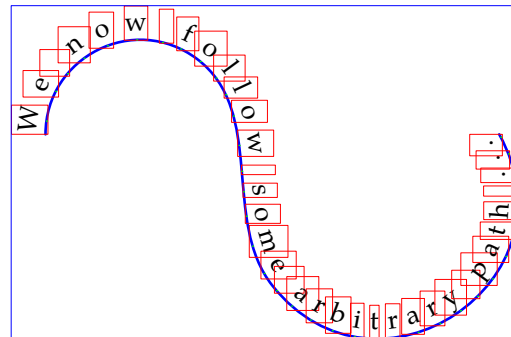
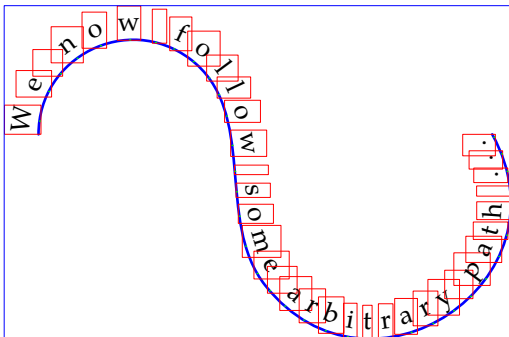

When turned on, tracing will produce bounding boxes as well as draw the path. Tracing can be turned on by saying:

```
\startMPinclusions
  boolean TraceRot ; TraceRot := true ;
\stopMPinclusions
```

The next example is dedicated to Giuseppe Bilotta who wants to handle multiple strings and uses a patched version of `\followtokens`. To avoid a complicated explanation, we will present an alternative here that uses overlays. This method also avoids complicated path definitions.

```
\startoverlay
```

```

{\startuseMPgraphic{followtokens}
  draw fullcircle scaled 5cm .
  withpen pencircle scaled 1pt withcolor .625yellow ;
  draw fullsquare scaled 5.25cm
  withpen pencircle scaled 1pt withcolor .625red ;
  drawoptions (withcolor .625red) ;
  path RotPath ; RotPath := halfcircle scaled 5cm ;
  setbounds currentpicture to boundingbox fullcircle scaled 5.25cm ;
\stopuseMPgraphic
\followtokens { Met{\`a} superiore }}
{\startuseMPgraphic{followtokens}
  drawoptions (withcolor .625red) ;
  path RotPath ; RotPath := halfcircle rotated 90 scaled 5cm ;
  setbounds currentpicture to boundingbox fullcircle scaled 5.25cm ;
\stopuseMPgraphic
\followtokens { {${\star$} }}
{\startuseMPgraphic{followtokens}
  drawoptions (withcolor .625red) ;
  path RotPath ; RotPath := halfcircle rotated 180 scaled 5cm ;
  setbounds currentpicture to boundingbox fullcircle scaled 5.25cm ;
\stopuseMPgraphic
\followtokens { Met{\`a} inferiore }}
{\startuseMPgraphic{followtokens}
  drawoptions (withcolor .625red) ;
  path RotPath ; RotPath := halfcircle rotated 270 scaled 5cm ;
  setbounds currentpicture to boundingbox fullcircle scaled 5.25cm ;
\stopuseMPgraphic
\followtokens { {${\star$} }}
\stopoverlay

```

In order to fool the overlay macro that each graphic has the same size, we force a bounding box.

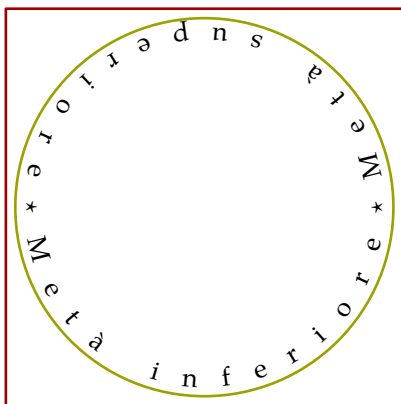

10.5 Talking to T_EX

Sometimes, others may say oftentimes, we are in need for some fancy typesetting. If we want to typeset a paragraph of text in a non standard shape, like a circle, we have to fall back on `\parshape`. Unfortunately, T_EX is not that strong in providing the specifications of more complicated shapes,

unless you are willing to do some complicated arithmetic \TeX . Given that METAPOST knows how to deal with shapes, the question is: “Can METAPOST be of help?”

In the process of finding out how to deal with this, we first define a simple path. Because we are going to replace pieces of code, we will compose the graphic from components. First, we create the path.

```
\startuseMPgraphic{text path}
  path p ; p := ((0,1)..(-1,0)..(1,0)--cycle) scaled 65pt ;
\stopuseMPgraphic
```

This shape is not that beautiful, but it has a few characteristics that will help us to identify border-cases.

```
\startuseMPgraphic{text draw}
  drawarrow p withpen pencircle scaled 1pt withcolor red ;
\stopuseMPgraphic
```

Now we use CONTEXT 's `\includeMPgraphic` command to build our graphic from the previously defined components.

```
\startuseMPgraphic{text}
  \includeMPgraphic{text path}
  \includeMPgraphic{text draw}
\stopuseMPgraphic
```

When called with `\useMPgraphic{text}`, we get:

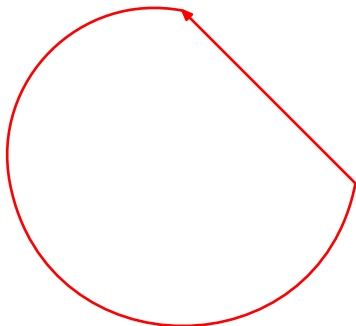

For the moment we start the path at $(x = 0, y > 0)$, but later using more complicated macros, we will see that we can use arbitrary paths.

We are going to split the path in two, and will use the points that make up the bounding box as calculated by METAPOST. The next graphic shows one of these points, the lower left corner, available as point `llcorner p`.

```
\startuseMPgraphic{text draw}
  draw p withpen pencircle scaled 3pt withcolor red ;
  draw boundingbox p withpen pencircle scaled 1pt ;
  draw llcorner p withpen pencircle scaled 5pt ;
\stopuseMPgraphic
```

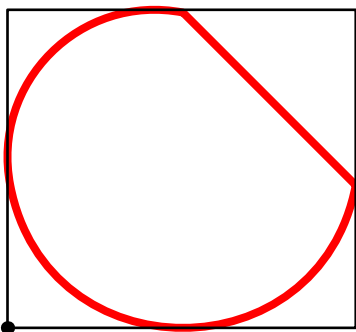

The five points that METAPOST can report for each path or picture are:

```
llcorner  lower left corner
lrcorner  lower right corner
urcorner  upper right corner
ulcorner  upper left corner
center    intersection of the diagonals
```

If we want to typeset text inside this circle, we need to know where a line starts and ends. Given that lines are horizontal and straight, we therefore need to calculate the intersection points of the lines and the path. As a first step, we calculate the top and bottom of the path and after that we split off the left and right path.

```
\startuseMPgraphic{text split}
  pair t, b ; path l, r ;

  t := (ulcorner p -- urcorner p) intersectionpoint p ;
  b := (llcorner p -- lrcorner p) intersectionpoint p ;

  l := p cutbefore t ; l := l cutafter b ;
  r := p cutbefore b ; r := r cutafter t ;
\stopuseMPgraphic
```

The `intersectionpoint` macro returns the point where two paths cross. If the paths don't cross, an error is reported, when the paths cross more times, just one point is returned. The `cutafter` and `cutbefore` commands do as their names say and return a path.

In the `text split` code fragment, `t` and `b` are the top points of the main path, while `l` and `r` become the left and right half of path `p`.

We now draw the original path using a thick pen and both halves with a thinner pen on top of the original. The arrows show the direction.

```
\startuseMPgraphic{text draw}
  draw      p withpen pencircle scaled 3pt withcolor red ;
  drawarrow l withpen pencircle scaled 1pt withcolor green ;
  drawarrow r withpen pencircle scaled 1pt withcolor blue ;
\stopuseMPgraphic
```

We use `\includeMPgraphic` to assemble the components:

```
\startuseMPgraphic{text}
  \includeMPgraphic{text path}
```

```

\includeMPgraphic{text split}
\includeMPgraphic{text draw}
\stopuseMPgraphic

```

This graphic is typeset with `\useMPgraphic{text}`:

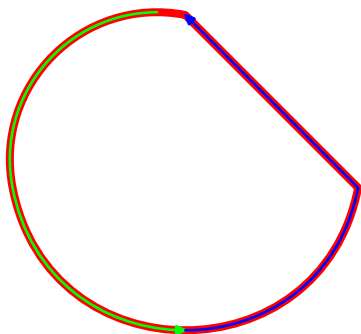

Before we are going to use them, we define some variables that specify the text. We use a baseline distance of 8 points. The part of the line above the baseline is 7.2 points, while the (maximum) depth is 2.8 points. These ratios are the ones we use in `CONTEXT`. Because we don't want the text to touch the circle so we define an offset too.

```

\startuseMPgraphic{text vars}
  baselineskip := 8pt ;
  strutheight  := (7.2/10) * baselineskip ;
  strutdepth   := (2.8/10) * baselineskip ;
  offset       := baselineskip/2 ;
  topskip      := strutheight ;
\stopuseMPgraphic

```

We more or less achieve the offset by scaling the path. In doing so, we use the width and height, which we call `hsize` and `vsize`, thereby conforming to the `TEX` naming scheme.

First we calculate both dimensions from the bounding box of the path. Next we down scale the path to compensate for the offset. When done, we recalculate the dimensions.

```

\startuseMPgraphic{text move}
  pair t, b ; path q, l, r ;

  hsize := xpart lrcorner p - xpart llcorner p ;
  vsize := ypart urcorner p - ypart lrcorner p ;

  q := p xscaled ((hsize-2offset)/hsize)
      yscaled ((vsize-2offset)/vsize) ;

  hsize := xpart lrcorner q - xpart llcorner q ;
  vsize := ypart urcorner q - ypart lrcorner q ;
\stopuseMPgraphic

```

We adapt the `text split` code to use the reduced path instead of the original.

```

\startuseMPgraphic{text split}
  t := (ulcorner q -- urcorner q) intersectionpoint q ;
  b := (llcorner q -- lrcorner q) intersectionpoint q ;

```

```

l := q cutbefore t ; l := l cutafter b ;
r := q cutbefore b ; r := r cutafter t ;
\stopuseMPgraphic

```

In order to test what we have reached so far, we draw the original path, the left and right part of the reduced path, and both the top and bottom point.

```

\startuseMPgraphic{text draw}
drawarrow p withpen pencircle scaled 1pt withcolor red ;
draw      t withpen pencircle scaled 2pt ;
draw      b withpen pencircle scaled 2pt ;
drawarrow l withpen pencircle scaled 1pt withcolor green ;
drawarrow r withpen pencircle scaled 1pt withcolor blue ;
\stopuseMPgraphic

```

Again we use `\includeMPgraphic` to combine the components into a graphic.

```

\startuseMPgraphic{text}
\includeMPgraphic{text path} \includeMPgraphic{text vars}
\includeMPgraphic{text move} \includeMPgraphic{text split}
\includeMPgraphic{text draw}
\stopuseMPgraphic

```

Then we use `\useMPgraphic{text}` to call up the picture.

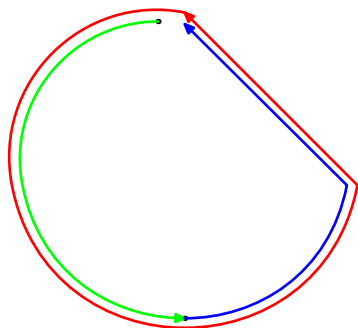

The offset is not optimal. Note the funny gap at the top. We could try to fix this, but there is a better way to optimize both paths.

We lower the top edge of `q`'s bounding box by `topskip`, then cut any part of the left and right pieces of `q` that lie above it. Similarly, we raise the bottom edge and cut off the pieces that fall below this line.

```

\startuseMPgraphic{text cutoff}
path tt, bb ;

tt := (ulcorner q -- urcorner q) shifted (0,-topskip) ;
bb := (llcorner q -- lrcorner q) shifted (0,strutdepth) ;

l := l cutbefore (l intersectionpoint tt) ;
l := l cutafter  (l intersectionpoint bb) ;
r := r cutbefore (r intersectionpoint bb) ;
r := r cutafter  (r intersectionpoint tt) ;
\stopuseMPgraphic

```



Because we use `\includeMPgraphic` to construct the graphic, we can redefine `text draw` to show the result of this effort.

```
\startuseMPgraphic{text draw}
  drawarrow p withpen pencircle scaled 1pt withcolor red ;
  drawarrow l withpen pencircle scaled 1pt withcolor green ;
  drawarrow r withpen pencircle scaled 1pt withcolor blue ;
\stopuseMPgraphic
```

The text graphic now becomes:

```
\startuseMPgraphic{text}
  \includeMPgraphic{text path}   \includeMPgraphic{text vars}
  \includeMPgraphic{text move}  \includeMPgraphic{text split}
  \includeMPgraphic{text cutoff} \includeMPgraphic{text draw}
\stopuseMPgraphic
```

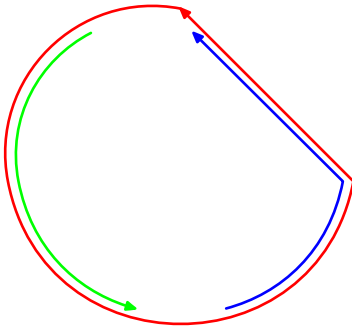
Or, as graphic:



We are now ready for an attempt to calculate the shape of the text. For each line, we have to calculate the left and right intersection points, and since a line has a height and depth, we have to determine which part touches first.

```
\startuseMPgraphic{text calc}
  vardef found_point (expr lin, pat, sig) =
    pair a, b ;
    a := pat intersection_point (lin shifted (0, strutheight)) ;
    if intersection_found :
      a := a shifted (0, -strutheight) ;
    else :
      a := pat intersection_point lin ;
    fi ;
    b := pat intersection_point (lin shifted (0, -strutdepth)) ;
    if intersection_found :
      if sig :
        if xpart b > xpart a : a := b shifted (0, strutdepth) fi ;
      else :
        if xpart b < xpart a : a := b shifted (0, strutdepth) fi ;
      fi ;
    fi ;
  a
```

```

    \enddef ;
\stopuseMPgraphic

```

Instead of using METAPOST's `intersectionpoint` macro, we use one that comes with `CONTEXT`. That way we don't get an error message when no point is found, and can use a boolean flag to take further action. Since we use a `vardef`, all calculations are hidden and the `a` at the end is returned, so that we can use this macro in an assignment. The `sig` variable is used to distinguish between the beginning and end of a line (the left and right subpath).

```

\startuseMPgraphic{text step}
  path line; pair lll, rrr ;

  for i=topskip step baselineskip until vsize :
    line := (ulcorner q -- urcorner q) shifted (0,-i) ;

    lll := found_point(line,l,true) ;
    rrr := found_point(line,r,false) ;
  \stopuseMPgraphic

```

Here we divide the available space in lines. The first line starts at `strutheight` from the top.

We can now finish our graphic by visualizing the lines. Both the height and depth of the lines are shown.

```

\startuseMPgraphic{text line}
  fill (lll--rrr--rrr shifted (0,strutheight)--lll
    shifted (0,strutheight)--cycle) withcolor .5white ;
  fill (lll--rrr--rrr shifted (0,-strutdepth)--lll
    shifted (0,-strutdepth)--cycle) withcolor .7white ;
  draw lll withpen pencircle scaled 2pt ;
  draw rrr withpen pencircle scaled 2pt ;
  draw (lll--rrr) withpen pencircle scaled .5pt ;
\stopuseMPgraphic

\startuseMPgraphic{text done}
  endfor ;
\stopuseMPgraphic

```

The result is still a bit disappointing.

```

\startuseMPgraphic{text}
  \includeMPgraphic{text path}      \includeMPgraphic{text vars}
  \includeMPgraphic{text move}      \includeMPgraphic{text split}
  \includeMPgraphic{text cutoff}    \includeMPgraphic{text draw}
  \includeMPgraphic{text calc}      \includeMPgraphic{text step}
  \includeMPgraphic{text line}      \includeMPgraphic{text done}
\stopuseMPgraphic

```

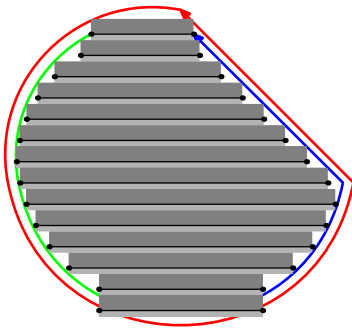

In order to catch the overflow at the bottom, we need to change the for-loop a bit, so that the number of lines does not exceed the available space. The test that surrounds the assignment of `vsize` makes sure that we get better results when we (on purpose) take a smaller height.

```
\startuseMPgraphic{text step}
  path line; pair lll, rrr ; numeric vsize ;

  if (strutheight+strutdepth<baselineskip) :
    vsize := vsize ;
  else :
    vsize := (vsize div baselineskip) * baselineskip ;
  fi ;

  for i=topskip step baselineskip until vsize :
    line := (ulcorner q -- urcorner q) shifted (0,-i) ;
    lll := found_point(line,l,true) ;
    rrr := found_point(line,r,false) ;
  \stopuseMPgraphic
```

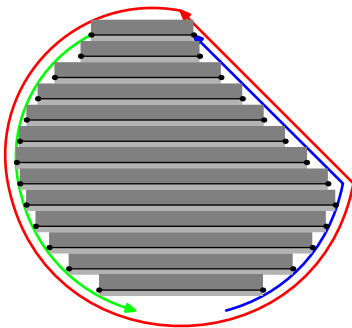

We can manipulate the height and depth of the lines to give different (and maybe better) results.

```
\startuseMPgraphic{text vars}
  baselineskip := 8pt ;
  strutheight  := 4pt ;
  strutdepth   := 2pt ;
  offset       := 4pt ;
  topskip      := 3pt ;
  \stopuseMPgraphic
```

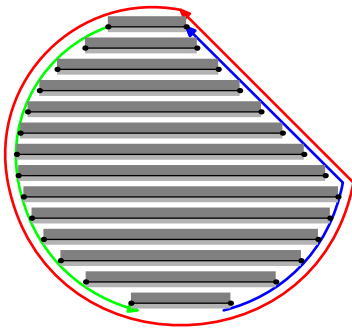

This kind of graphic trickery in itself is not enough to get \TeX into typesetting within the bounds of a closed curve. Since METAPOST can write information to a file, and \TeX can read such a file, a natural way to handle this is to let METAPOST write a `\parshape` specification.

```
\startuseMPgraphic{text macro}
  def provide_parshape (expr p, offset, baselineskip,
    strutheight, strutdepth, topskip) =
    \includeMPgraphic{text move}
    \includeMPgraphic{text split}
    \includeMPgraphic{text cutoff}
    \includeMPgraphic{text draw}
    \includeMPgraphic{text calc}
    \includeMPgraphic{text loop}
    \includeMPgraphic{text save}
  enddef ;
\stopuseMPgraphic
```

We have to adapt the for-loop to register the information about the lines. After the loop we write those values to a file using another loop.

```
\startuseMPgraphic{text loop}
  path line; pair lll, rrr ; numeric vvsize, n ; n := 0 ;
  if (strutheight+strutdepth<baselineskip) :
    vvsize := vsize ;
  else :
    vvsize := (vsize div baselineskip) * baselineskip ;
  fi ;
  for i=topskip step baselineskip until vvsize :
    line := (ulcorner q -- urcorner q) shifted (0,-i) ;
    lll := found_point(line,l,true) ;
    rrr := found_point(line,r,false) ;
    n := n + 1 ;
    indent[n] := abs(xpart lll - xpart llcorner q) ;
    width[n] := abs(xpart rrr - xpart lll) ;
  endfor ;
\stopuseMPgraphic
```

```

\startuseMPgraphic{text save}
  write "\parshape " & decimal n to "mfun-mp-data.txt" ;
  for i=1 upto n:
    write decimal indent[i]&"bp " &
      decimal width[i]&"bp " to "mfun-mp-data.txt" ;
  endfor ;
  write EOF to "mfun-mp-data.txt" ;
\stopuseMPgraphic

```

We can call this macro using the part we used in the previous examples.

```

\startuseMPgraphic{text}
  \includeMPgraphic{text macro}

  path p ; p := ((0,1)..(-1,0)..(1,0)--cycle) scaled 65pt ;

  provide_parshape
    (p,                % shape path
     .5*\baselinedistance, % offset
     \baselinedistance, % distance between lines
     \strutheight,      % height of a line
     \strutdepth,       % depth of a line
     \strutheight) ;   % height of first line
\stopuseMPgraphic

```

After we called `\useMPgraphic{text}`, the resulting file looks as follows. You can call up this file by its anonymous name `\MPdatafile`, since this macro gets the value of the graphic at hand.

```

\parshape 8
21.25648bp 46.39665bp
16.79666bp 54.3987bp
6.52979bp 77.31822bp
1.44792bp 95.05238bp
1.77025bp 107.38231bp
6.4069bp 106.13466bp
14.96152bp 89.02438bp
31.50317bp 55.9419bp

```

So, reading in this file at the start of a paragraph will setup \TeX to follow this shape.

The final implementation is a bit more complicated since it takes care of paths that are not centered around the origin and don't start at the top point. We achieve this by moving the path to the center:

```
cp := center p ; q := p shifted - cp ;
```

The arbitrary starting point is taken care of by a slightly more complicated path cutter. First we make sure that the path runs counterclockwise.

```
if xpart directionpoint t of q < 0 : q := reverse q fi ;
```

Knowing this, we can split the path in two, using a slightly different splitter:

```
l := q cutbefore t ;
l := l if xpart point 0 of q < 0 : & q fi cutafter b ;
```

```
r := q cutbefore b ;
r := r if xpart point 0 of q > 0 : & q fi cutafter t ;
```

As always, when implementing a feature like this, some effort goes into a proper user interface. In doing so, we need some \TeX trickery that goes beyond this text, like collecting text and splitting of the part needed. Also, we want to be able to handle multiple shapes at once, like the next example demonstrates.

10.6 Libraries

The macro discussed in the previous section is included in one of the METAPOST libraries, so we first have to say:

```
\useMPLibrary[txt]
```

We define four shapes. They are not really beautiful, but they demonstrate what happens in border cases. For instance, too small first lines are ignored. First we define a circle. Watch how the dimensions are set in the graphic. The arguments passed to `build_parshape` are: path, an offset, an additional horizontal and vertical displacement, the baseline distance, the height and depth of the line, and the height of the first line (topskip in \TeX terminology). The height and depth of a line are often called strut height and depth, with a strut being an invisible character with maximum dimensions.

```
\startuseMPgraphic{test 1}
  path p ; p := fullcircle scaled 6cm ;

  build_parshape(p,6pt,0,0,\baselinedistance,
    \strutheight,\strutdepth,\strutheight) ;

  draw p withpen pencircle scaled 1pt ;
\stopuseMPgraphic
```

The second shape is a diamond. This is a rather useless shape, unless the text suits the small lines at the top and bottom.

```
\startuseMPgraphic{test 2}
  path p ; p := fullsquare rotated 45 scaled 5cm ;

  build_parshape(p,6pt,0,0,\baselinedistance,
    \strutheight,\strutdepth,\strutheight) ;

  draw p withpen pencircle scaled 1pt ;
\stopuseMPgraphic
```

The third and fourth shape demonstrate that providing a suitable offset is not always trivial.

```
\startuseMPgraphic{test 3}
  numeric w, h ; w := h := 6cm ;
  path p ; p := (.5w,h) -- (0,h) -- (0,0) -- (w,0) &
    (w,0) .. (.75w,.5h) .. (w,h) & (w,h) -- cycle ;

  build_parshape(p,6pt,0,0,\baselinedistance,
    \strutheight,\strutdepth,\strutheight) ;

  draw p withpen pencircle scaled 1pt ;
```

```
\stopuseMPgraphic
```

Contrary to the first three shapes, here we use a different path for the calculations and the drawing. Watch carefully! If, instead of an offset, we pass a path, METAPOST is able to calculate the right dimensions and offsets. This is needed, since we need these later on.

```
\startuseMPgraphic{test 4}
  numeric w, h, o ;

  def shape = (o,o) -- (w-o,o) & (w-o,o) .. (.75w-o,.5h) ..
    (w-2o,h-o) & (w-2o,h-o) -- (o,h-o) -- cycle
  enddef ;

  w := h := 6cm ; o := 6pt ; path p ; p := shape ;
  w := h := 6cm ; o := 0pt ; path q ; q := shape ;

  build_parshape(p,q,6pt,6pt,\baselinedistance,
    \strutheight,\strutdepth,\strutheight) ;

  draw q withpen pencircle scaled 1pt ;
\stopuseMPgraphic
```

Since we also want these graphics as backgrounds, we define them as overlays. If you don't want to show the graphic, you may omit this step.

```
\defineoverlay[test 1][\useMPgraphic{test 1}]
\defineoverlay[test 2][\useMPgraphic{test 2}]
\defineoverlay[test 3][\useMPgraphic{test 3}]
\defineoverlay[test 4][\useMPgraphic{test 4}]
```

As text, we use a quote from Douglas R. Hofstadter's book "Metamagical Themas, Questing for the Essence of Mind and Pattern". Watch how we pass a list of shapes.

```
\startshapetext[test 1,test 2,test 3,test 4]
  \forgetall % as it says
  \setupalign[verytolerant,stretch,normal]%
  \input douglas % Douglas R. Hofstadter
\stopshapetext
```

Finally we combine text and shapes. Since we also want a background, we use `\framed`. The macros `\parwidth` and `\parheight` are automatically set to the current shape dimensions. The normal result is shown in figure 10.3.

```
\startbuffer
\setupframed
  [offset=overlay,align=normal,frame=off,
  width=\parwidth,height=\parheight]
\startcombination[2*2]
  {\framed[background=test 1]{\getshapetext}} {test 1}
  {\framed[background=test 2]{\getshapetext}} {test 2}
  {\framed[background=test 3]{\getshapetext}} {test 3}
  {\framed[background=test 4]{\getshapetext}} {test 4}
\stopcombination
\stopbuffer
```

By using a buffer we keep `\placefigure` readable.

```
\placefigure
[here][fig:shapes]
{A continuous text, typeset in a non||standard shape,
spread over four areas, and right aligned.}
{\getbuffer}
```

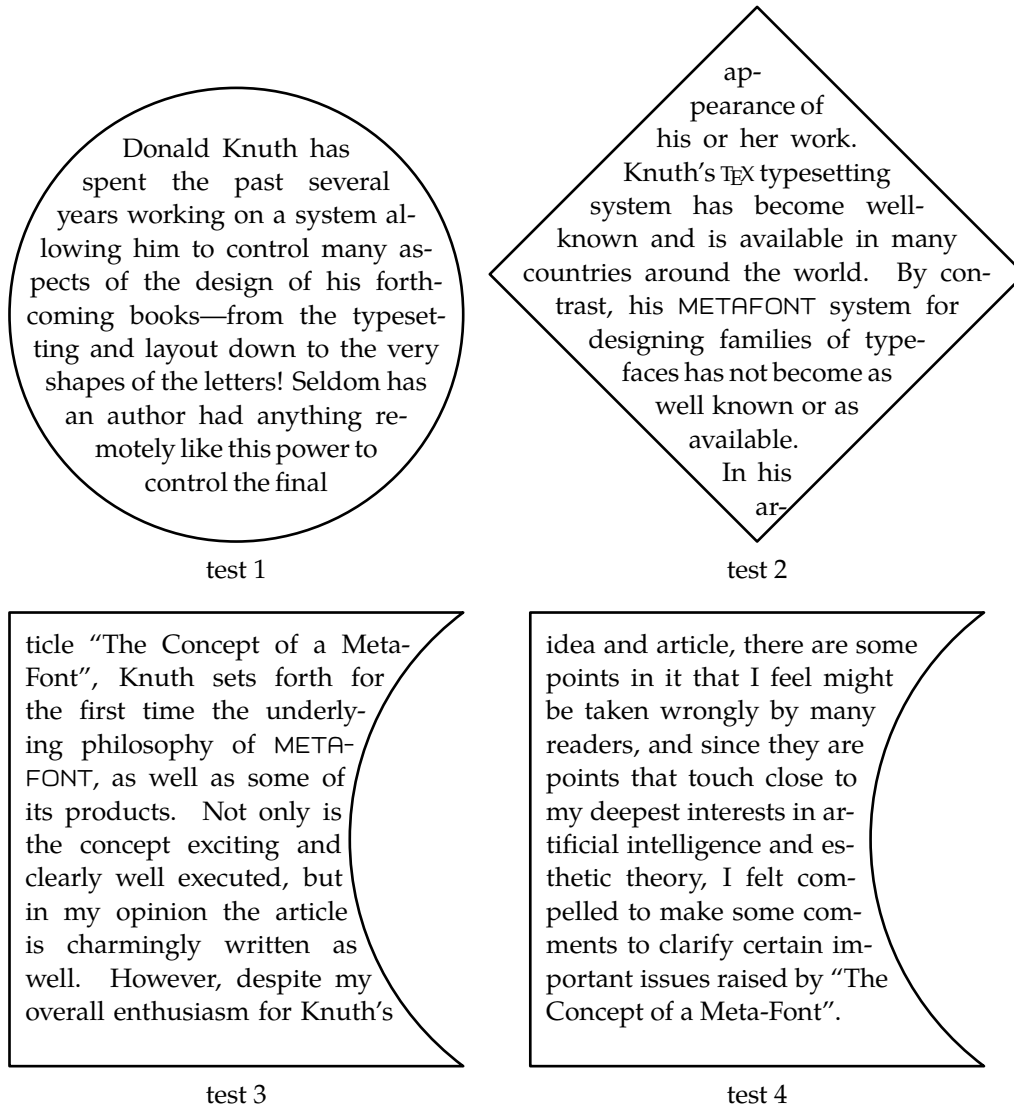

Figure 10.3 A continuous text, typeset in a non–standard shape, spread over four areas, and right aligned.

The traced alternative is shown in figure 10.4. This one is defined as:

```
\placefigure
[here][fig:traced shapes]
{A continuous text, typeset in a non||standard shape,
spread over four areas (tracing on).}
```



```
{\startMPinclusions
  boolean trace_parshape ; trace_parshape := true ;
\stopMPinclusions
\getbuffer}
```

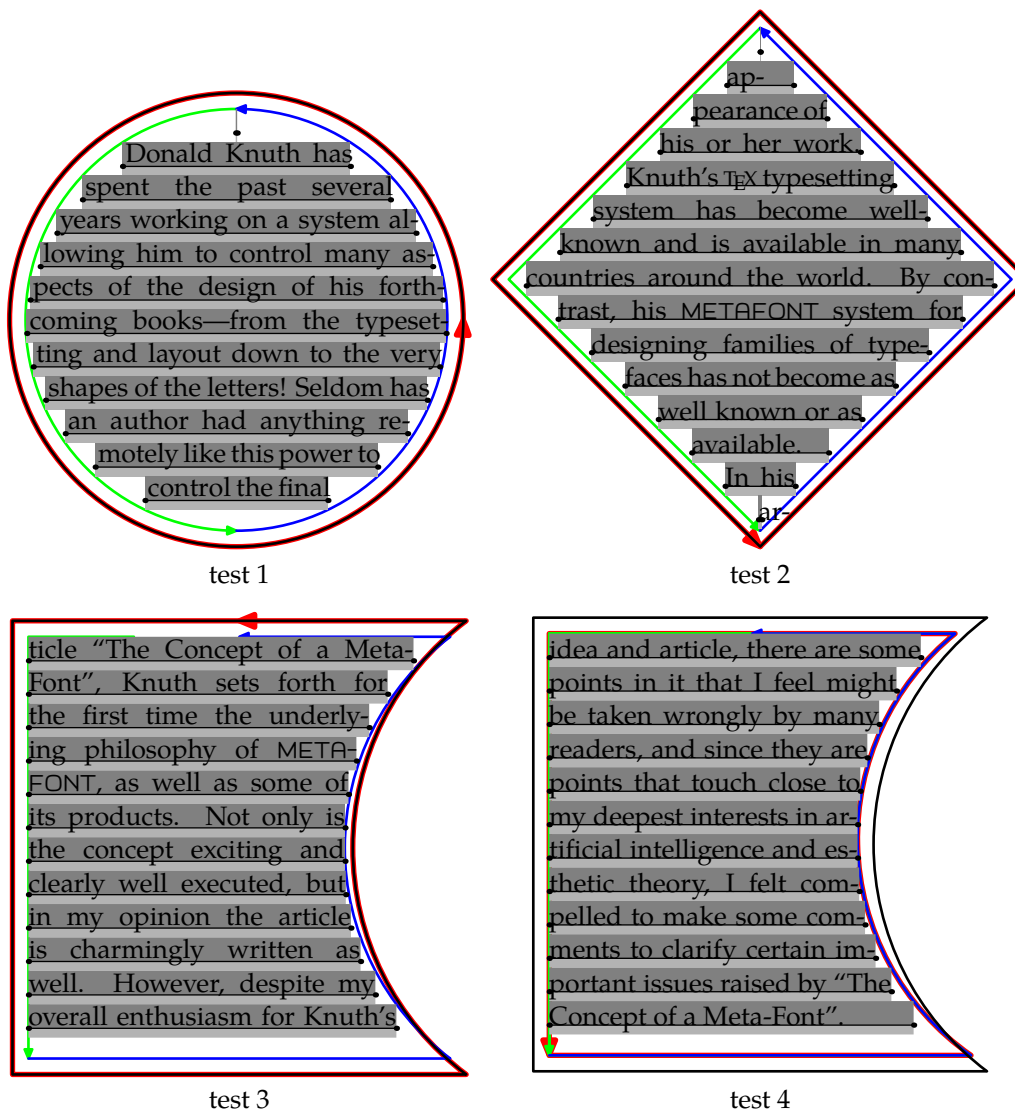

Figure 10.4 A continuous text, typeset in a non-standard shape, spread over four areas (tracing on).

We can combine all those tricks, although the input is somewhat fuzzy. First we define a quote typeset in a circular paragraph shape.

```
\startuseMPgraphic{center}
  build_parshape(fullcircle scaled 8cm,0,0,0,\baselinedistance,
    \strutheight,\strutdepth,\strutheight) ;
\stopuseMPgraphic
\startshapetext[center]
```

```

\input douglas
\stopshapetext

\defineoverlay[center][\useMPgraphic{center}]

```

We will surround this text with a circular line, that we define as follows. By using a buffer we keep things organized.

```

\startbuffer[circle]
\startuseMPgraphic{followtokens}
  path RotPath ; RotPath := reverse fullcircle
    rotatedaround(origin,90)
    xscaled \overlaywidth yscaled \overlayheight ;
  drawoptions (withcolor .625red) ;
\stopuseMPgraphic

\followtokens
  {This is just a dummy text, kerned by \TeX\ and typeset
    in a circle using \MetaPost.\quad}
\stopbuffer

\defineoverlay[edge][{\getbuffer[circle]}]

```

The text and graphics come together in a framed text:

```

\startbuffer[quote]
\framed
  [offset=24pt,
  background=edge,
  frame=off,
  backgroundoffset=-18pt]
  {\getshapetext}
\stopbuffer

\placefigure
  {One more time Hofstadter's quotation (normal).}
  {\getbuffer[shape,quote]}

\placefigure
  {One more time Hofstadter's quotation (traced).}
  {\startMPinclusions
    boolean TraceRot ; TraceRot := true ;
    \stopMPinclusions
    \getbuffer[shape,quote]}

```

Donald Knuth has spent the past several years working on a system allowing him to control many aspects of the design of his forthcoming books—from the typesetting and layout down to the very shapes of the letters! Seldom has an author had anything remotely like this power to control the final appearance of his or her work. Knuth's \TeX typesetting system has become well-known and is available in many countries around the world. By contrast, his METAFONT system for designing families of typefaces has not become as well known or as available.

In his article "The Concept of a Meta-Font", Knuth sets forth for the first time the underlying philo-

Figure 10.5 One more time Hofstadter's quotation (normal).

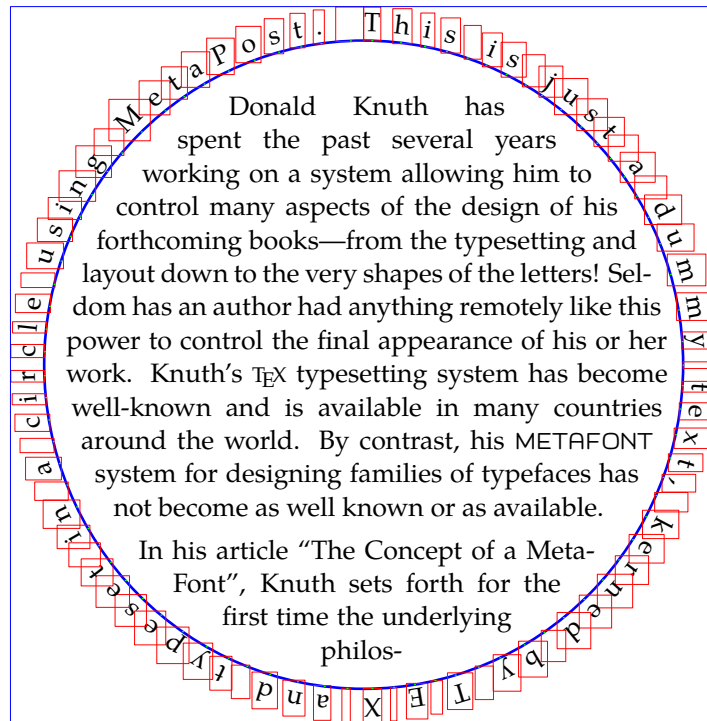

Figure 10.6 One more time Hofstadter's quotation (traced).

11 Debugging

Those familiar with `CONTEXT` will know that it has quite some visual debugging features build in. So, what can you expect of the `METAPOST` macros that come with `CONTEXT`? In this chapter we will introduce a few commands that show some insight in what `METAPOST` is doing.

11.1 Showing paths

Since the outcome of `METAPOST` code is in many respects more predictable than that of `TEX` code, we don't need that advanced visual debugging features. Nevertheless we provide a few, that are all based on visualizing paths.

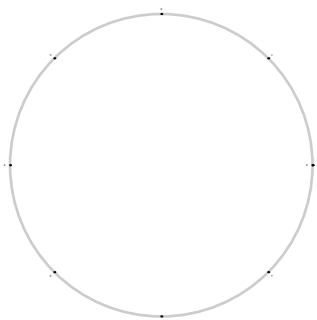

This visualization is achieved by using dedicated drawing commands:

```
path p ; p := fullcircle scaled 4cm ;
drawpath p ; drawpoints p ; drawpointlabels p ;
```

Since control points play an important role in defining the shape, visualizing them may shed some insight in what `METAPOST` is doing.

```
path p ; p := fullcircle xscaled 4cm yscaled 3cm ;
drawpath p ; drawcontrollines p ;
drawpoints p ; drawcontrolpoints p ; drawpointlabels p ;
```

The pre and post control points show up as small dots and are connected to their parent point with thin lines.

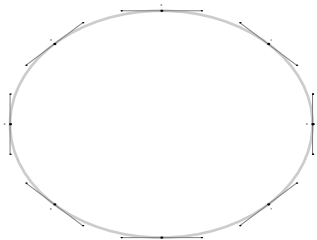

You can deduce the direction of a path from the way the points are numbered, but using an arrow to indicate the direction is more clear.

```
path p ; p := fullcircle xscaled 4cm yscaled 3cm ;
drawarrowpath p ; drawcontrollines p ;
```

```
drawpoints p ; drawcontrolpoints p ; drawpointlabels p ;
```

The `drawarrowpath` is responsible for the arrow. Especially when you are in the process of defining macros that have to calculate intersections or take subpaths, knowing the direction may be of help.

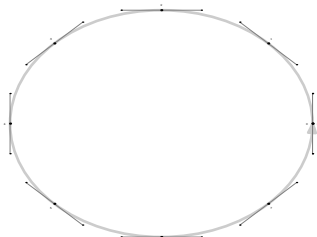

The next table summarizes the special drawing commands:

<code>drawpath</code>	the path
<code>drawarrowpath</code>	the direction of the path
<code>drawcontrollines</code>	the lines to the control points
<code>drawpoints</code>	the points that make up the path
<code>drawcontrolpoints</code>	the control points of the points
<code>drawpointlabels</code>	the numbers of the points

You can set the characteristics of these like you set `drawoptions`. The default settings are as follows:

```
drawpathoptions (withpen pencircle scaled 5 withcolor .8white) ;
drawpointoptions (withpen pencircle scaled 4 withcolor black) ;
drawcontroloptions(withpen pencircle scaled 2.5 withcolor black) ;
drawlineoptions (withpen pencircle scaled 1 withcolor .5white) ;
drawlabeloptions () ;
```

Two more options are `draworiginoptions` and `drawboundoptions` which are used when visualizing the bounding box and origin.

```
swappointlabels := true ;
path p ; p := fullcircle xscaled 4cm yscaled 3cm ;
drawarrowpath p ; drawcontrollines p ;
drawpoints p ; drawcontrolpoints p ; drawpointlabels p ;
drawboundingbox p ; draworigin ;
```

In this example we have set `swappointlabels` to change the place of the labels. You can set the variable `originlength` to tune the appearance of the origin.

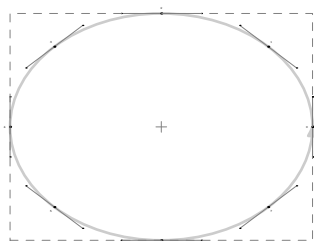

You can pass options directly, like you do with `draw` and `fill`. Those options override the defaults.

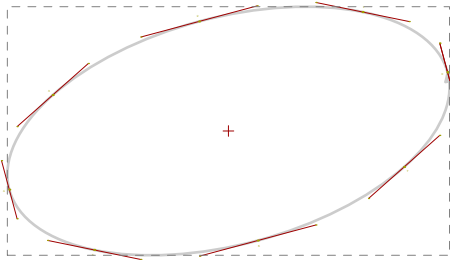

Here we used the options:

```
path p ; p := fullcircle xscaled 6cm yscaled 3cm rotated 15 ;
drawarrowpath p ;
drawcontrollines p withcolor .625red ;
drawpoints p withcolor .625yellow ;
drawcontrolpoints p withcolor .625yellow ;
drawpointlabels p withcolor .625yellow ;
drawboundingbox p ;
draworigin withcolor .625red ;
```

Sometimes it makes sense to draw a simple coordinate system, and for that purpose we have three more macros. They draw axis and tickmarks.

```
drawticks unitsquare xscaled 4cm yscaled 3cm shifted (-1cm,-1cm) ;
```

The system drawn is based on the bounding box specification of the path passed to the macro. You can also draw one axis, using `drawxticks` or `drawyticks`. Here we show the previous command.

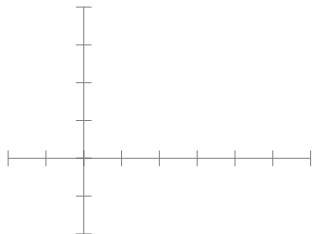

By default, the ticks are placed at .5cm distance, but you can change this by setting `tickstep` to a different value.

```
tickstep := 1cm ; ticklength := 2mm ;
drawticks fullsquare xscaled 4cm yscaled 3cm ;
tickstep := tickstep/2 ; ticklength := ticklength/2 ;
drawticks fullsquare xscaled 4cm yscaled 3cm ;
```

The `ticklength` variable specifies the length of a tick. Here we manipulated both the variables to get a more advanced system.

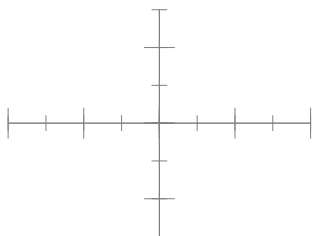

If visualizing a path would mean that we would have to key in all those draw-commands, you could hardly call it a comfortable tool. Therefore, we can say:

```
drawwholepath fullsquare scaled 3cm rotated 30 randomized 5mm ;
```

The `drawwholepath` command shows everything except the axis.

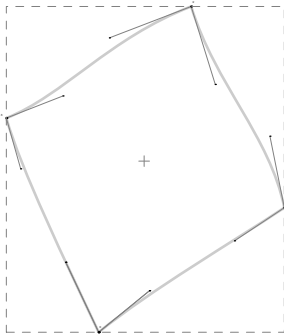

If even this is too much labour, you may say:

```
visualizepaths ;
```

This redefines the `draw` and `fill` command in such a way that they also show all the information.

```
visualizepaths ;
draw fullsquare scaled 3cm rotated 30 randomized 2mm ;
```

You may compare this feature to the `\showmakeup` command available in `CONTEXT`, that redefines the `TEX` primitives that deal with boxes, glues, penalties, and alike.

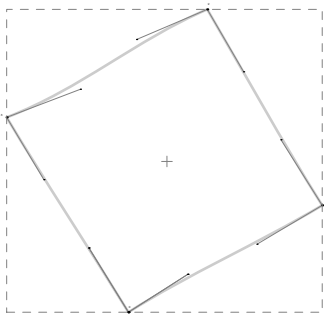

Of course you may want to take a look at the `METAPOST` manual for its built in (more verbose) tracing options. One command that may prove to be useful is `show`, that you can apply to any variable. This command reports the current value (if known) to the terminal and log file.



The previous picture shows what is typeset when we also say `\showmakeup`. This command visualizes \TeX 's boxes, skips, kerns and penalties. As you can see, there are some boxes involved, which is due to the conversion of METAPOST output to PDF.

```
\startlinecorrection[blank]
... the graphic ...
\stoplinecorrection
```

The small bar is a kern and the small rectangles are penalties. More details on this debugger can be found in the $\text{CON}\TeX$ T manuals and the documentation of the modules involved.

11.2 Comments

Sometimes, when trouble strikes, you might want to peek in the PDF file to see what gets written there. Each graphic is marked with a number but when you have many it might make sense to add a comment to help you locate the code.

```
\startMPcode
  comment("test graphic") ;
  message("processing a test graphic") ;
  draw fullsquare scaled 1cm ;
\stopMPcode
```

This renders as:



On the console we get these messages:

```
metapost > message : processing a test graphic
metapost > warning : processing a test graphic
```

And in the PDF file we will find:

```
% mps graphic 1: begin
% mps graphic 1: test graphic
q 0 g 0 G 10 M 1 j 1 J
0.500000000 w
-14.173233032 -14.173233032 m
14.173233032 -14.173233032 l
14.173233032 14.173233032 l
-14.173233032 14.173233032 l
-14.173233032 -14.173233032 l
h S
0 g 0 G Q
% mps graphic 1: end
```

Here are some examples of constructed messages:

```
message "2:          okay          (done)" ;
message "1: " & dq      & "okay" & dq & " (done)" ;
```

```

message "3: " & quotation "okay"      & " (done)" ;
message "3: " & quote      "okay"      & " (done)" ;
message "4: " & quotation 123          & " (done)" ;
message "5: " & quotation true         & " (done)" ;
message "6: " & quote      true         & " (done)" ;
message "7: " & tostring  true         & " (done)" ;
message "8: " & tostring  (1,2)        & " (done)" ;
message "9: " & topair    (1,2)        & " (done)" ;

```

and this is what you get:

```

metapost > message : 2: okay (done)
metapost > message : 1: "okay" (done)
metapost > message : 3: "okay" (done)
metapost > message : 3: 'okay' (done)
metapost > message : 4: "123" (done)
metapost > message : 5: "true" (done)
metapost > message : 6: 'true' (done)
metapost > message : 7: true (done)
metapost > message : 8: 1 2 (done)
metapost > message : 9: (1,2) (done)

```

11.3 Pens

A circular pen is applied to a path in a different way than for instance a square pen. Circular pens are mapped onto POSTSCRIPT pens while for other pens an outline is calculated that gets filled. Take this code:

```

\startMPcode
  draw fullcircle xscaled 6cm yscaled 3cm
    withpen pensquare scaled 5mm rotated 30
    withcolor .625yellow ;
\stopMPcode

```

and this:

```

\startMPcode
  draw envelope pensquare scaled 5mm rotated 30 of
    (fullcircle xscaled 6cm yscaled 3cm)
    withpen pencircle scaled 1mm
    withcolor .375white ;
\stopMPcode

```

and:

```

\enabletrackers[metapost.forcestroke]
\startMPcode
  draw fullcircle xscaled 6cm yscaled 3cm
    withpen pensquare scaled 5mm rotated 30
    withcolor .625red ;
\stopMPcode

```

```
\disabletrackers[metapost.forcestroke]
```

When we overlay these three we get. The envelope only returns the outer curve.

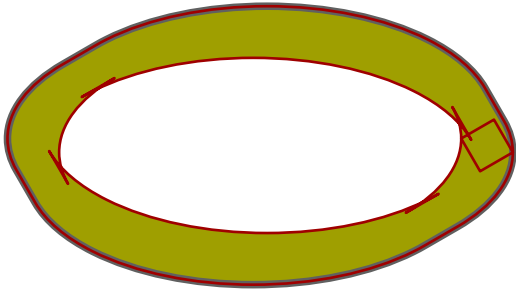

12 Defining styles

Since the integration of METAPOST into CONTEX, a complete new range of layout features became available. In this document we have introduced several ways to include graphics in your document definition. In this chapter we go one step further and make dynamic graphics part of a document style.

12.1 Adaptive buttons

So far we have seen a lot of graphic ingredients that you can use to make your documents more attractive. In this chapter we will define a simple document style. This style was written for the PDFTEX presentations at the TUG 2000 conference in Oxford (UK).

This style exploits a few tricks, like graphics calculated using positional information. It also demonstrates how you can make menu buttons that dynamically adapt their shapes to the rest of the page layout.

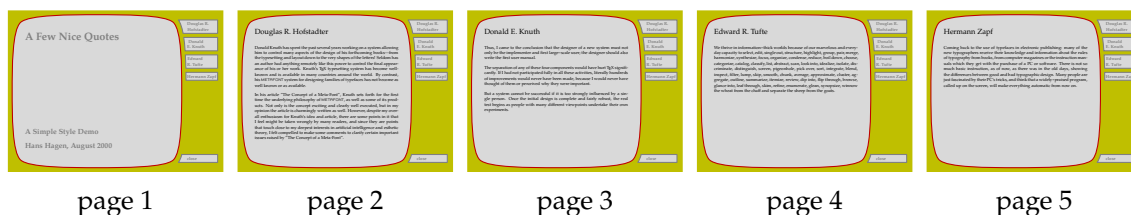

Later we will see an instance with some more randomness in the graphics. While writing this style, the random alternative made me think of those organic buildings with non equal windows —we have a few of those in The Netherlands—, so I decided to label this style as pre-organic. If you use CONTEX, you can load this style with:

```
\usemodule[pre-organic]
```

At the end of this file, there is a small test file, so when you process the file `s-pre-19.tex`¹⁴ with the options `--mode=demo` and `--pdf`, you will get a demo document.

We use one of the standard screen ‘paper’ sizes, and map it onto the same size, so that we get a nicely cropped page. Other screen sizes are S4 and S5.

```
\setuppapersize[S6][S6]
```

Like in this METAFUN manual, we use the Palatino as main bodyfont. This font is quite readable on even low resolution screens, although I admit that this style is developed using an 1400 × 1050 pixel LCD screen, so the author may be a little biased.

```
\setupbodyfont[pl]
```

The layout specification sets up a text area and a right edge area where the menus will go (see chapter 6 for a more in depth discussion on the layout areas). Watch how we use a rather large edge distance. By setting the header and footer dimensions to zero, we automatically get rid of page body ornaments, like the page number.

¹⁴ This style is the 19th presentation style. Those numbered styles are internally mapped onto more meaningful names like in this case `pre-organic`.

```
\setuplayout
  [topspace=48pt,
   backspace=48pt,
   cutspace=12pt,
   width=400pt,
   margin=0cm,
   rightrightedge=88pt,
   rightrightedgedistance=48pt,
   header=0cm,
   footer=0cm,
   height=middle]
```

We use a moderate, about a line height, inter-paragraph white space.

```
\setupwhitespace[big]
```

Of course we use colors, since on computer displays they come for free.

```
\setupcolors[state=start]

\definecolor [red]    [r=.75]
\definecolor [yellow] [r=.75,g=.75]
\definecolor [gray]   [s=.50]
\definecolor [white]  [s=.85]
```

Because it is an interactive document, we have to enable hyperlinks and alike. However, in this style, we disable the viewer's 'highlight a hyperlink when it's clicked on' feature. We will use a menu, so we enable menus. Later we will see the contrast color —hyperlinks gets that color when we are already on the location— in action.

```
\setupinteraction
  [state=start,
   click=off,
   color=red,
   contrastcolor=gray,
   menu=on]
```

The menu itself is set up as follows. Because we will calculate menu buttons based on their position on the page, we have to keep track of the positions. Therefore, we set the `position` variable to `yes`.

```
\setupinteractionmenu
  [right]
  [frame=off,
   position=yes,
   align=middle,
   topoffset=-.75cm,
   bottomoffset=-.75cm,
   color=gray,
   contrastcolor=gray,
   style=bold,
   before=,
   after=]
```

The menu content is rather sober: just a list of topics and a close button. Later we will define the command that generates topic entries. The alternative `right` lets the topic list inherit its characteristics from the menu.

```
\startinteractionmenu[right]
  \placelist[Topic][alternative=right]
  \vfill
  \but [CloseDocument] close \\
\stopinteractionmenu
```

We have now arrived at the more interesting part of the style definition: the graphic that goes in the page background. Because this graphic will change, we define a useable METAPOST graphic. Page backgrounds are recalculated each page, opposite to the other backgrounds that are calculated when a new background is defined, or when repetitive calculation is turned on.

```
\setupbackgrounds [page] [background=page]
\defineoverlay [page] [\useMPgraphic{page}]
\setupMPvariables [page] [alternative=3]
```

We will implement three alternative backgrounds. First we demonstrate the relatively simple super ellipsed one. The main complication is that we want the button shapes to follow the right edge of the curve that surrounds the text. We don't know in advance how many lines of text there will be in a button, and we also don't know at what height it will end up. Therefore, we need to calculate each button shape independently and for that purpose we need to know its position (see chapter 5). In figure 12.1 you can see what lines we need in order to be calculate the button shapes.

We separate the calculation of the button shape from the rest by embedding it in its own usable graphic container. The `StartPage-StopPage` pair takes care of proper placement of the whole graphic.

```
\startuseMPgraphic{page}
  \includeMPgraphic{rightsuperbutton}
  StartPage ;
  path p, q ; pickup pencircle scaled 3pt ;
  p := Field[Text][Text] enlarged 36pt superellipsed .90 ;
  fill Page withcolor \MPcolor{yellow} ;
  fill p withcolor \MPcolor{white} ;
  draw p withcolor \MPcolor{red} ;
  p := Field[Text][Text] enlarged 48pt superellipsed .90 ;
  def right_menu_button (expr nn, rr, pp, xx, yy, ww, hh, dd) =
    if (pp>0) and (rr>0) :
      q := rightsuperbutton(p,xx,yy,RightEdgeWidth,hh) ;
      fill q withcolor \MPcolor{white} ;
      draw q withcolor if rr=2 : \MPcolor{gray}
                       else : \MPcolor{red} fi ;
    fi ;
  enddef ;
  \MPmenubuttons{right}
```

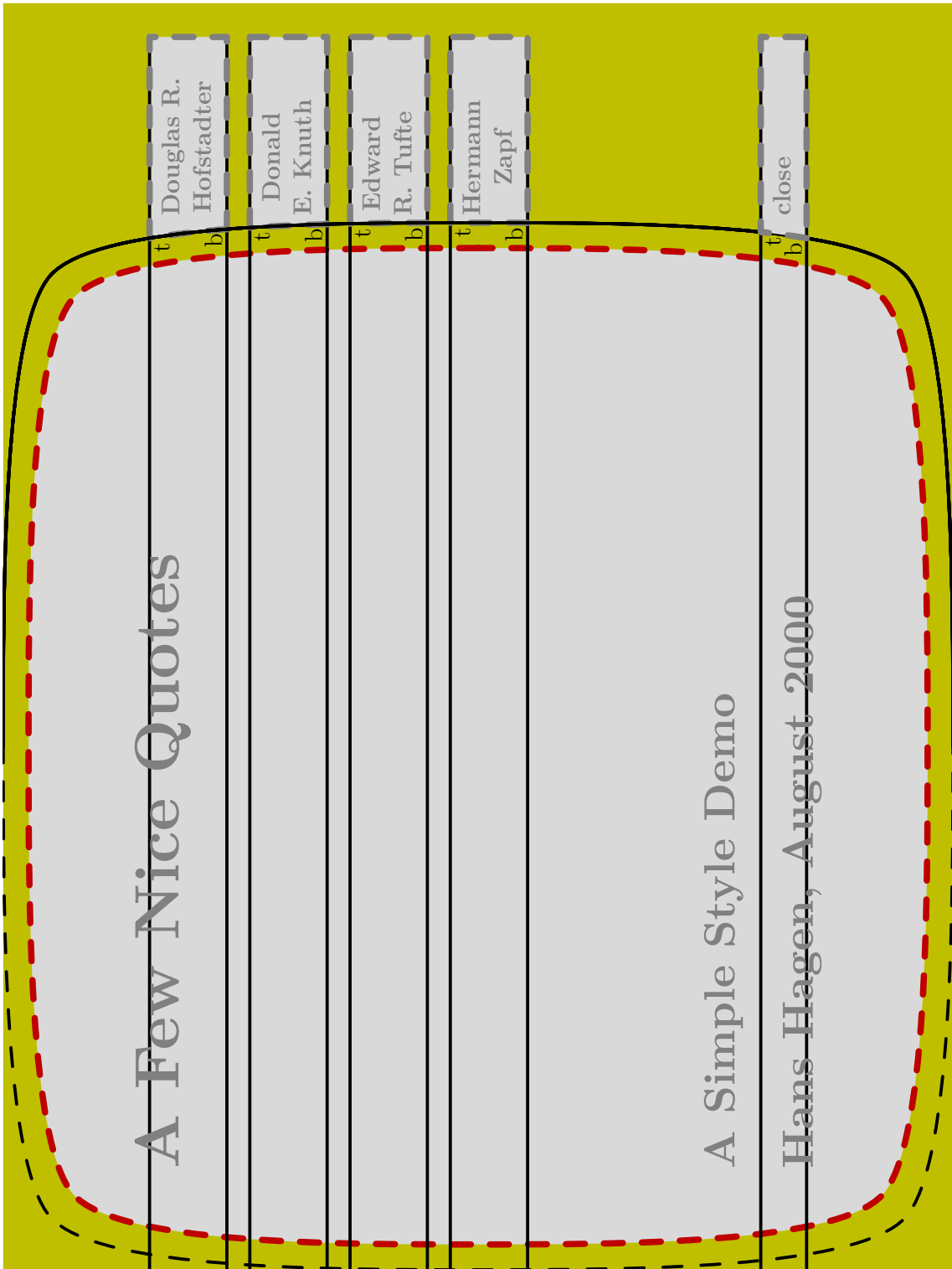

Figure 12.1 The auxiliary lines used to calculate the button shapes.

```
StopPage ;
\stopuseMPgraphic
```

The \TeX macro `\MPmenubuttons` expands into a list of (in this case four) calls to the `METAPOST` macro `right_menu_button`. This list is generated by `CONTEXT` when it generates the menu. Because the page background is applied last, this list is available at that moment.

```
... (expr nn, rr, pp, xx, yy, ww, hh, dd) ...
```

This rather long list of arguments represents the following variables: number, referred page, current page, x coordinate, y coordinate, width, height and depth. The last six variables originate from the positioning mechanism. Because the variables are only available after a second \TeX pass, we only draw a button shape when the test for the page numbers succeeds.

```
\startuseMPgraphic{rightsuperbutton}
vardef rightsuperbutton (expr pat, xpos, ypos, wid, hei) =
  save p, ptop, pbot, t, b, edge, shift, width, height ;
  path p, ptop, pbot ; pair t, b ;
  numeric edge, shift, width, height ;

  edge := xpos + wid ; shift := ypos + hei ;

  p := rightpath pat ;

  ptop := ((-infinity,shift)--(edge,shift)) ;
  pbot := ((-infinity,shift-hei)--(edge,shift-hei)) ;

  t := p intersectionpoint ptop ;
  b := p intersectionpoint pbot ;

  p := subpath(0,xpart (p intersectiontimes ptop)) of p ;
  p := subpath(xpart (p intersectiontimes pbot),length(p)) of p ;

  (p --
    t -- point 1 of ptop &
    point 1 of ptop -- point 1 of pbot &
    point 1 of pbot -- b
  -- cycle)

enddef ;
\stopuseMPgraphic
```

The calculation of the button itself comes down to combining segments of the main shape and auxiliary lines. The `rightpath` macro returns the right half of the path provided. This half is shown as a non dashed line.

Topics are identified with `\Topic`, which is an instance of chapter headings. The number is made invisible. Since it still is a numbered section header, `CONTEXT` will write the header to the table of contents.

```
\definehead [Topic] [chapter]
\setuphead [Topic] [number=no]
```

We will use a bold font in the table of contents. We also force a complete list.

```
\setuplist
[Topic]
```

```
[criterium=all,
 style=bold,
 before=,
 after=]
```

The \TitlePage macro looks horrible, because we want to keep the interface simple: a list of small sentences, separated by \\.

```
\def\TitlePage#1%
{\startstandardmakeup
 \switchtobodyfont [big]
 \def\{\vfill\bf\let\=\par}
 \bfd\setupinterlinespace\gray
 \vskip.5cm#1\\vskip.5cm % \\ is really needed -)
 \stopstandardmakeup}
```

A presentation that uses this style, may look like the one below. You can choose among three alternatives.

```
\useenvironment [pre-organic] \setupoutput [pdftex]
\setupMPvariables [page] [alternative=1]
\starttext
\TitlePage
{A Few Nice Quotes\\
 A Simple Style Demo\\
 Hans Hagen, August 2000}
\Topic {Douglas R. Hofstadter} \input douglas \page
\Topic {Donald E. Knuth} \input knuth \page
\Topic {Edward R. Tufte} \input tufte \page
\Topic {Hermann Zapf} \input zapf \page
\stoptext
```

We will not implement the two other alternative shapes: squeezed and randomized.

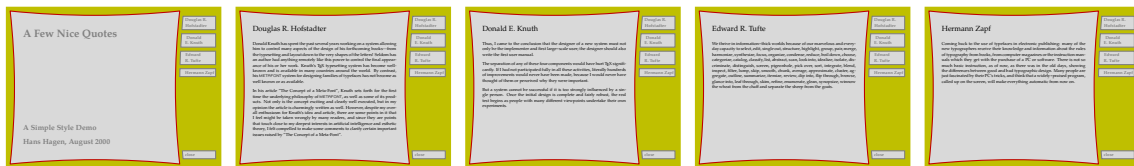

page 1 page 2 page 3 page 4 page 5

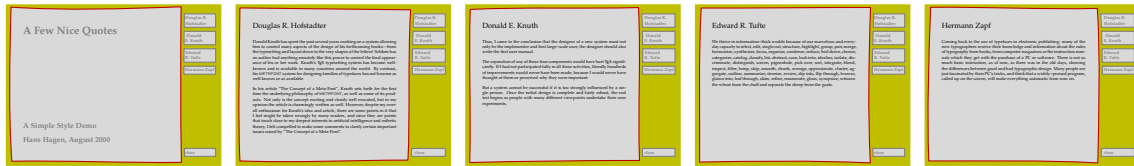

page 1 page 2 page 3 page 4 page 5

We combine all alternatives into one page graphic. The alternative is chosen by setting the alternative variable, as we demonstrated in the example.

```
\startuseMPgraphic{page}
  \includeMPgraphic{rightsuperbutton}
  StartPage ;
  numeric alternative, seed, superness, squeezezness, randomness ;
  path p, q ; transform t ;
```

This is one of those cases where a transform variable is useful. We need to store the random seed value because we want the larger path that is used in the calculations to have the same shape.

```
alternative := \MPvar{alternative} ;
seed        := uniformdeviate 100 ;

if alternative > 10 :
  superness  := .85 + ((\realfolio-1)/max(\lastpage,1)) * .25 ;
  squeezezness := 12pt - ((\realfolio-1)/max(\lastpage,1)) * 10pt ;
else :
  superness  := .90 ;
  squeezezness := 12pt ;
fi ;

randomness := squeezezness ;

alternative := alternative mod 10 ;
```

If you read closely, you will notice that when we add 10 to the alternative, we get a page dependant graphic. So, in fact we have five alternatives. We use `CONTEXT` macros to fetch the (real) page number and the number of the last page. In further calculations we use the lower alternative numbers, which is why we apply a mod.

The rest of the code is not so much different from the previous definition. The hard coded point sizes match the page dimensions (600pt by 450pt) quite well.

```
t := identity if alternative=3: shifted (9pt,-9pt) fi ;
randomseed := seed ;

p := Field[Text][Text] enlarged if
  alternative = 1 : 36pt superellipsed superness elseif
  alternative = 2 : 36pt squeezed squeezezness elseif
  alternative = 3 : 36pt randomized randomness else
                  : 36pt fi ;

pickup pencircle scaled 3pt ;

fill Page withcolor \MPcolor{yellow} ;
fill p withcolor \MPcolor{white} ;
draw p withcolor \MPcolor{red} ;

randomseed := seed ;

p := ( Field[Text][Text] enlarged if
  alternative = 1 : 48pt superellipsed superness elseif
```

```

alternative = 2 : 48pt squeezed      squeezeiness elseif
alternative = 3 : 36pt randomized   randomness else
      : 48pt fi ) transformed t ;

def right_menu_button (expr nn, rr, pp, xx, yy, ww, hh, dd) =
  if (pp>0) and (rr>0) :
    q := rightsuperbutton(p,xx,yy,RightEdgeWidth,hh) ;
    fill q withcolor \MPcolor{white} ;
    draw q withcolor if rr=2 : \MPcolor{gray}
      else : \MPcolor{red} fi ;

  fi ;
enddef ;

\MPmenubuttons{right}

StopPage ;
\stopuseMPgraphic

```

When we choose the alternatives 21 and 22 we get this result:

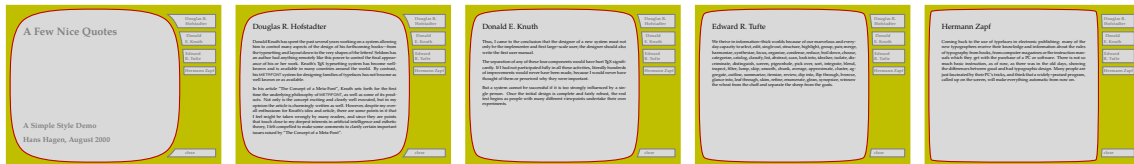

page 1

page 2

page 3

page 4

page 5

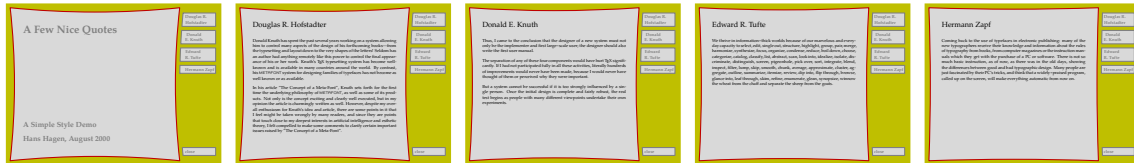

page 1

page 2

page 3

page 4

page 5

13 A few applications

For those who need to be inspired, we will demonstrate how METAPOST can be used to enhance your document with simple graphics. In these examples we will try to be not too clever, simply because we lack the experience to be that clever. The real tricks can be found in the files that come with METAPOST.

13.1 Simple drawings

In the words of John Hobby, the creator of METAPOST, “METAPOST is particularly well-suited for generating figures for technical documents where some aspects of a picture may be controlled by mathematical or geometrical constraints that are best expressed symbolically. In other words, METAPOST is not meant to take the place of a freehand drawing tool or even an interactive graphics editor”.

An example of such a picture is the following one, which is dedicated to David Arnold, who asked me once how to draw a spring. So, imagine that we want to draw a schematic view of a system of four springs.

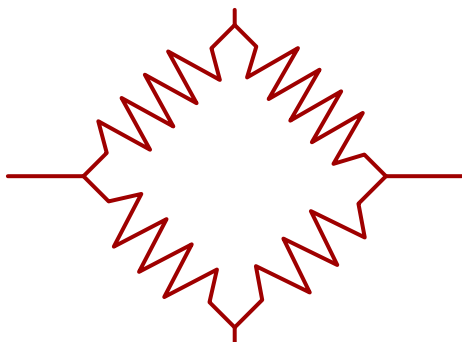

A rather natural way to define such a system is:

```
z1 = (+2cm,0) ; z2 = (0,+2cm) ;
z3 = (-2cm,0) ; z4 = (0,-2cm) ;

pickup pencircle scaled 1.5pt ;
drawoptions (withcolor .625red) ;

draw spring (z1, z2, .75cm, 2, 10) ; draw z1 -- 1.5 z1 ;
draw spring (z2, z3, .75cm, 2, 9) ; draw z2 -- 1.1 z2 ;
draw spring (z3, z4, .75cm, 2, 8) ; draw z3 -- 1.5 z3 ;
draw spring (z4, z1, .75cm, 2, 7) ; draw z4 -- 1.1 z4 ;
```

Here, the macro `spring` takes 5 arguments: two points, the width of the winding, the length of the connecting pieces, and the number of elements (half windings). The definition of `spring` is less complicated than readable.

```
def spring (expr a, b, w, h, n) =
  ( ( (0,0) -- (0,h) --
    for i=1 upto n-1: (if odd(i) : - fi w/2,i+h) -- endfor
    (0,n+h) -- (0,n+2h) )
```

```

yscaled ((xpart (b-a) ++ ypart (b-a))/(n+2h))
rotatedaround(origin,-90+angle(b-a))
shifted a )
\enddef ;

```

First we build a path starting in the origin, going left or right depending on the counter being an odd number.

```

pat := (0,0) ;
for i=1 upto n-1:
  if odd(i) :
    pat := pat -- (-w/2,i) ;
  else :
    pat := pat -- (+w/2,i) ;
  fi ;
endfor ;
pat := pat -- (0,n) ;

```

Once you are accustomed to the way METAPOST interprets (specialists may say expand) the source code, you will start using `if` and `for` statements in assignments. The previous code can be converted in a one liner, using the pattern:

```

pat := for i=1 upto n-1: (x,y)-- endfor (0,n) ;

```

The loop splits out a series of `(x,y)--` but the last point is added outside the loop. Otherwise `pat` would have ended with a dangling `--`. Of course we need to replace `(x,y)` by something meaningful, so we get:

```

pat := for i=1 upto n-1: (if odd(i):-fi w/2,i)--endfor (0,n) ;

```

We scale this path to the length needed. The expression $b - a$ calculates a vector, starting at a and ending at b . In METAPOST, the expression `a++b` is identical to $\sqrt{a^2 + b^2}$. Thus, the expression `xpart (b-a) ++ ypart (b-a)` calculates the length of the vector $b - a$. Because the unscaled spring has length $n + 2h$, scaling by the expression `((xpart (b-a) ++ ypart (b-a)) / (n+2h))` gives the spring the same length as the vector $b - a$.

Because we have drawn our spring in the vertical position, we first rotate it 90 degrees clockwise to a horizontal position, and then rotate it through an angle equal to the angle in which the vector $b - a$ is pointing. After that, we shift it to the first point. The main complications are that we also want to draw connecting lines at the beginning and end, as well as support springs that connect arbitrary points. Since no check is done on the parameters, you should be careful in using this macro.

When we want to improve the readability, we have to use intermediate variables. Since the macro is expected to return a path, we must make sure that the content matches this expectation.

```

\vardef spring (expr a, b, w, h, n) =
  pair vec ; path pat ; numeric len ; numeric ang ;
  vec := (b-a) ;
  pat := for i=1 upto n-1: (if odd(i):-fi w/2,i)--endfor (0,n) ;
  pat := (0,0)--(0,h)-- pat shifted (0,h)--(0,n+h)--(0,n+2h) ;
  len := (xpart vec ++ ypart vec)/(n+2h) ;
  ang := -90+angle(vec) ;

```

```
( pat yscaled len rotatedaround(origin,ang) shifted a )
enddef ;
```

If you use `vardef`, then the last statement is the return value. Here, when `p := spring (z1, z2, .75cm, 2, 10)` is being parsed, the macro is expanded, the variables are kept invisible for the assignment, and the path at the end is considered to be the return value. In a `def` the whole body of the macro is 'pasted' in the text, while in a `vardef` only the last line is visible. We will demonstrate this with a simple example.

```
def one = (n,n) ; n := n+1 ; enddef ;
def two = n := n + 1 ; (n,n) enddef ;
```

Now, when we say:

```
pair a, b ; numeric n ; n= 10 ; a := one ; b := two ;
```

we definitely get an error message. This is because, when macro `two` is expanded, METAPOST sees something:

```
b := n := n + 1 ;
```

By changing the second definition in

```
vardef two = n := n + 1 ; (n,n) enddef ;
```

the increment is expanded out of sight for `b :=` and the pair `(n,n)` is returned.

We can draw a slightly better looking spring by drawing twice with a different pen. The following commands use the `spring` macro implemented by the `vardef`.

```
path p ; p :=
  (0,0)--spring((.5cm,0),(2.5cm,0),.5cm,0,10)--(3cm,0) ;
draw p withpen pencircle scaled 2pt ;
draw p withpen pencircle scaled 1pt withcolor .8white;
```

This time we get:



Since the `spring` macro returns a path, you can do whatever is possible with a path, like drawing an arrow:



Or even (watch how we use the neutral unit `u` to specify the dimensions):



This was keyed in as:

```
drawarrow
  (0,0)--spring((.5cm,0),(2.5cm,0),.5cm,0,10)--(3cm,0)
  withpen pencircle scaled 2pt withcolor .625red ;
```

and:

```

numeric u ; u := 1mm ; pickup pencircle scaled (u/2) ;
drawoptions (withcolor .625red) ;
draw (0,0)--spring((5u,0),(25u,0),5u,0,10)--(30u,0) ;
drawoptions (dashed evenly withcolor .5white) ;
draw (0,0)--spring((5u,0),(35u,0),(25/35)*5u,0,10)--(40u,0) ;

```

13.2 Free labels

The METAPOST label macro enables you to position text at certain points. This macro is kind of special, because it also enables you to influence the positioning. For that purpose it uses a special kind of syntax which we will not discuss here in detail.

```

pickup pencircle scaled 1mm ;
path p ; p := fullcircle scaled 3cm ;
draw p withcolor .625yellow ;
dotlabel.rt ("right" , point 0 of p) ;
dotlabel.urt ("upper right" , point 1 of p) ;
dotlabel.top ("top" , point 2 of p) ;
dotlabel.ulft ("upper left" , point 3 of p) ;
dotlabel.lft ("left" , point 4 of p) ;
dotlabel.llft ("lower left" , point 5 of p) ;
dotlabel.bot ("bottom" , point 6 of p) ;
dotlabel.lrt ("lower right" , point 7 of p) ;

```

The label command just typesets a text, while dotlabel also draws a dot at the position of the label. The thelabel (not shown here) command returns a picture.

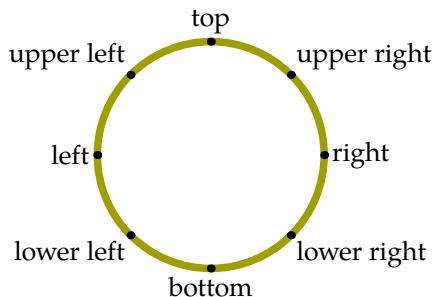

There is a numeric constant labeloffset that can be set to influence the distance between the point given and the content of the label. When we set the offset to zero, we get the following output.

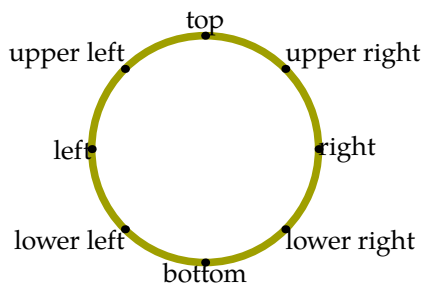

This kind of positioning works well as long as we know where we want the label to be placed. However, when we place labels automatically, for instance in a macro, we have to apply a few clever tricks. There are for sure many ways to accomplish this goal, but here we will follow the mathless method.

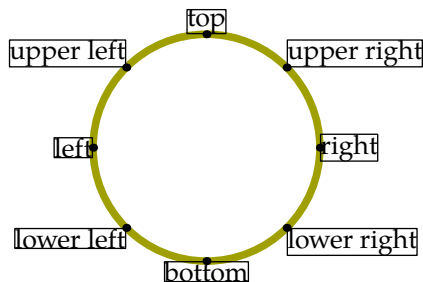

The previous graphic visualizes the bounding box of the labels. This bounding box is rather tight and therefore the placement of labels will always be suboptimal. Compare the alignment of the left- and rightmost labels. The `btex-etex` method is better, since then we can add struts, like:

```
btex \strut right etex
```

to force labels with uniform depths and heights. The next graphic demonstrates that this looks better indeed. Also, as \TeX does the typesetting we get the current text font instead of the label font and the content will be properly typeset; for instance kerning will be applied when applicable. Spending some time on such details pays back in better graphics.

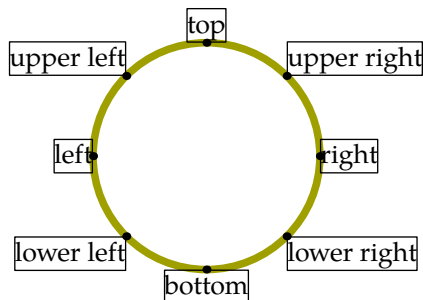

Now, what happens when we want to place labels in other positions? In the worst case, given that we place the labels manually, we end up in vague arguments in favour for one or the other placement.

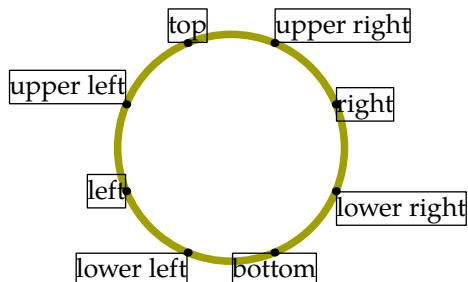

Although any automatic mechanism will be sub-optimal, we can give it a try to write a macro that deals with arbitrary locations. This macro will accept three arguments and return a picture.

```
thefreelabel("some string or picture",a position,the origin)
```

Our testcase is just a simple for loop that places a series of labels. The `freedotlabel` macro is derived from `thefreelabel`.

```
pickup pencircle scaled 1mm ;
path p ; p := fullcircle scaled 3cm ;
draw p withcolor .625yellow ;
for i=0 step .5 until 7.5 :
  freedotlabel ("text" , point i of p, center p) ;
endfor ;
```

As a first step we will simply place the labels without any correction. We also visualize the bounding box.

```
vardef thefreelabel (expr str, loc, ori) =
  save s ; picture s ; s := thelabel(str,loc) ;
  draw boundingbox s withpen pencircle scaled .5pt ;
  s
enddef ;
```

To make our lives more easy, we also define a macro that draws the dot as well as a macro that draws the label.

```
vardef freedotlabel (expr str, loc, ori) =
  drawdot loc ; draw thefreelabel(str,loc,ori) ;
enddef ;

vardef freelabel (expr str, loc, ori) =
  draw thefreelabel(str,loc,ori) ;
enddef ;
```

Now we get:

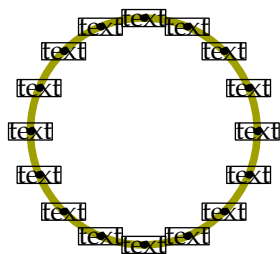

The original label macros permits us to align the label at positions, 4 corners and 4 points halfway the sides. It happens that circles are also composed of 8 points. Because in most cases the label is to be positioned in the direction of the center of a curve and the point at hand, it makes sense to take circles as the starting points for positioning the labels.

To help us in positioning, we define a special square path, `freesquare`. This path is constructed out of 8 points that match the positions that are used to align labels.

```
path freesquare ;
freesquare := ((-1,0)--(-1,-1)--(0,-1)--(+1,-1)--
              (+1,0)--(+1,+1)--(0,+1)--(-1,+1)--cycle) scaled .5 ;
```

We now show this free path together with a circle, using the following definitions:

```

drawpath      fullcircle scaled 3cm ;
drawpoints    fullcircle scaled 3cm ;
drawpointlabels fullcircle scaled 3cm ;
currentpicture := currentpicture shifted (5cm,0) ;
drawpath      freesquare scaled 3cm ;
drawpoints    freesquare scaled 3cm ;
drawpointlabels freesquare scaled 3cm ;

```

We use two drawing macros that are part of the suite of visual debugging macros.

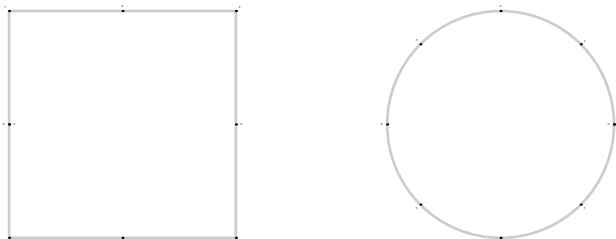

As you can see, point 1 is the corner point that suits best for alignment when a label is put at point 1 of the circle. We will now rewrite `thefreelabel` in such a way that the appropriate point of the associated `freesquare` is found.

```

vardef thefreelabel (expr str, loc, ori) =
  save s, p, q, l ; picture s ; path p, q ; pair l ;
  s := thelabel(str,loc) ;
  p := fullcircle scaled (2*length(loc-ori)) shifted ori ;
  q := freesquare xyscaled (urcorner s - llcorner s) ;
  l := point (xpart (p intersectiontimes (ori--loc))) of q ;
  draw q shifted loc withpen pencircle scaled .5pt ;
  draw l shifted loc withcolor .625yellow ;
  draw loc withcolor .625red ;
  s
enddef ;

```

The macro `xyscaled` is part of `METAPOST` and scales in two directions at once. The `METAPOST` primitive `intersectiontimes` returns a pair of time values of the point where two paths intersect. The first part of the pair concerns the first path.

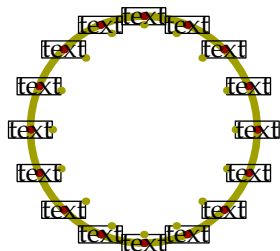

We are now a small step from the exact placement. If we change the last line of the macro into:

```
(s shifted -1)
```

we get the displacement we want. Although the final look and feel is also determined by the text itself, the average result is quite acceptable.

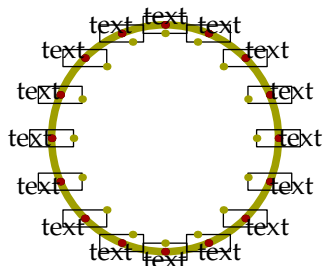

Because we also want to pass pictures, and add a bit of offset too, the final implementation is slightly more complicated. The picture is handled with an additional condition, and the offset with the METAFUN macro enlarged.

```
newinternal freelabeloffset ; freelabeloffset := 3pt ;
vardef thefreelabel (expr str, loc, ori) =
  save s, p, q, l ; picture s ; path p, q ; pair l ;
  interim labeloffset := freelabeloffset ;
  s := if string str : thelabel(str,loc)
      else          : str shifted -center str shifted loc fi ;
  setbounds s to boundingbox s enlarged freelabeloffset ;
  p := fullcircle scaled (2*length(loc-ori)) shifted ori ;
  q := freesquare xyscaled (urcorner s - llcorner s) ;
  l := point (xpart (p intersectiontimes (ori--loc))) of q ;
  setbounds s to boundingbox s enlarged -freelabeloffset ;
  (s shifted -l)
enddef ;
```

Watch how we temporarily enlarge the bounding box of the typeset label text. We will now test this macro on a slightly rotated circle, using labels typeset by \TeX . The reverse is there purely for cosmetic reasons, to suit the label texts.

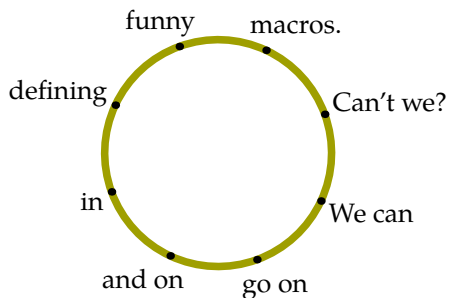

```
pickup pencircle scaled 1mm ;
path p ; p := reverse fullcircle rotated -25 scaled 3cm ;
draw p withcolor .625yellow ; pair cp ; cp := center p ;
freedotlabel (btex \strut We can      etex, point 0 of p, cp) ;
freedotlabel (btex \strut go on      etex, point 1 of p, cp) ;
freedotlabel (btex \strut and on     etex, point 2 of p, cp) ;
freedotlabel (btex \strut in        etex, point 3 of p, cp) ;
freedotlabel (btex \strut defining  etex, point 4 of p, cp) ;
freedotlabel (btex \strut funny     etex, point 5 of p, cp) ;
freedotlabel (btex \strut macros.   etex, point 6 of p, cp) ;
```

```
freedotlabel (btex \strut Can't we? etex, point 7 of p, cp) ;
```

Unfortunately we can run into problems due to rounding errors. Therefore we use a less readable but more safe expression for calculating the intersection points. Instead of using point `loc` as endpoint we use `loc` shifted over a very small distance into the direction `loc` from `ori`. In the assignment to `l` we replace `loc` by:

```
( (1+eps) * arclength(ori--loc) * unitvector(loc-ori) )
```

13.3 Marking angles

A convenient METAPOST macro is `unitvector`. When we draw a line segment from the origin to the point returned by this macro, the segment has a length of 1 base point. This macro has a wide range of applications, but some basic knowledge of vector algebra is handy. The following lines of METAPOST code demonstrate the basics behind unitvectors.

```
pair uv ; pickup pencircle scaled 1mm ; autoarrows := true ;
draw fullcircle scaled 2cm withcolor .625red ;
for i=(10,35), (-40,-20), (85,-15) :
  draw origin--i dashed evenly withcolor .625white ;
  drawarrow origin--unitvector(i) scaled 1cm withcolor .625yellow ;
endfor ;
draw origin withcolor .625red ;
```

The circle has a radius of 1cm, and the three line segments are drawn from the origin in the direction of the points that are passed as arguments. Because the vector has length of 1, we scale it to the radius to let it touch the circle. By setting `autoarrows` we make sure that the arrowheads are scaled proportionally to the linewidth of 1 mm.

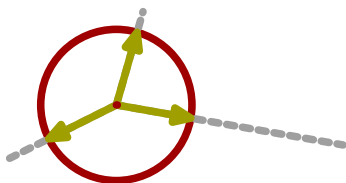

An application of this macro is drawing the angle between two lines. In the METAPOST manual you can find two macros for drawing angles: `mark_angle` and `mark_rt_angle`. You may want to take a look at their definitions before we start developing our own alternatives.

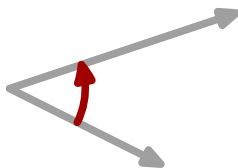

The previous graphic demonstrates what we want to accomplish: a circular curve indicating the angle between two straight lines. The lines and curve are drawn with the code:

```
pair a, b ; a := (2cm,-1cm) ; b := (3cm,1cm) ;
drawarrow origin--a ; drawarrow origin--b ;
drawarrow anglebetween(a,b) scaled 1cm withcolor .625red ;
```

where `anglebetween` is defined as:

```
def anglebetween (expr a, b) =
  (unitvector(a){a rotated 90} .. unitvector(b))
enddef ;
```

Both `unitvectors` return just a point on the line positioned 1 unit (later scaled to 1cm) from the origin. We connect these points by a curve that starts in the direction at the first point. If we omit the `a rotated 90` direction specifier, we get:

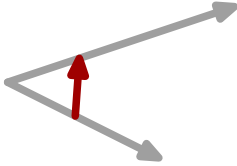

These definitions of `anglebetween` are far from perfect. If we don't start in the origin, we get the curve in the wrong place and when we swap both points, we get the wrong curve.

The solution for the displacement is given in the METAPOST manual and looks like this (we package the macro a bit different):

```
def anglebetween (expr endofa, endofb, common, length) =
  (unitvector (endofa-common){(endofa-common) rotated 90} ..
   unitvector (endofb-common)) scaled length shifted common
enddef ;
```

As you can see, we compensate for the origin of both vectors. This macro is called with a few more parameters. We need to pass the length, since we want to add the shift to the macro and the shift takes place after the scaling.

```
pair a, b, c ; a := (2cm,-1cm) ; b := (3cm,1cm) ; c := (-1cm,.5cm) ;
drawarrow c--a ; drawarrow c--b ;
drawarrow anglebetween(a,b,c,1cm) withcolor .625red ;
```

That the results are indeed correct, is demonstrated by the output of following example:

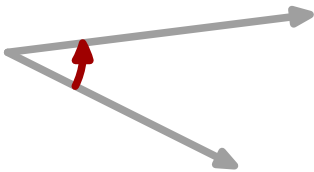

However, when we swap the points, we get:

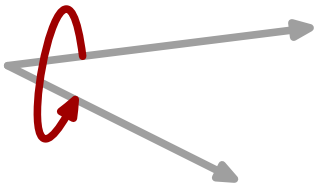

This means that instead of rotating over 90 degrees, we have to rotate over -90 or 270 degrees. That way the arrow will also point in the other direction. There are undoubtedly more ways to

determine the direction, but the following method also demonstrates the use of `turningnumber`, which reports the direction of a path. For this purpose we compose a dummy cyclic path.

```
vardef anglebetween (expr endofa, endofb, common, length) =
  save tn ; tn := turningnumber(common--endofa--endofb--cycle) ;
show tn ;
  (unitvector(endofa-common){(endofa-common) rotated (tn*90)} ..
  unitvector(endofb-common)) scaled length shifted common
enddef ;
```

Because we use an intermediate variable, just to keep things readable, we have to use `vardef` to hide the assignment for the outside world. We demonstrate this macro using the following code:

```
pair a, b, c ; a := (2cm,-1cm) ; b := (3cm,1cm) ; c := (-1cm,.5cm) ;
drawarrow c--a ; drawarrow c--b ;
drawarrow anglebetween(a,b,c,0.75cm) withcolor .625red ;
drawarrow anglebetween(b,a,c,1.50cm) withcolor .625red ;
```

Watch how both arrows point in the direction of the line that is determined by the second point.

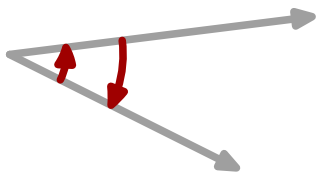

We now have the framework of an angle drawing macro ready and can start working placing the label.

```
vardef anglebetween (expr endofa, endofb, common, length, str) =
  save curve, where ; path curve ; numeric where ;
  where := turningnumber (common--endofa--endofb--cycle) ;
  curve := (unitvector(endofa-common){(endofa-common) rotated (where*90)} ..
  .. unitvector(endofb-common)) scaled length shifted common ;
  draw thefreelabel(str,point .5 of curve,common) withcolor black ;
  curve
enddef ;
```

The macro `thefreelabel` is part of `METAFUN` and is explained in detail in section 13.2. This macro tries to place the label as good as possible without user interference.

```
pair a ; a := (2cm,-1cm) ; drawarrow origin--a ;
pair b ; b := (3cm, 1cm) ; drawarrow origin--b ;
drawarrow
  anglebetween(a,b,origin,1cm,btex $\alpha$ etex)
  withcolor .625red ;
```

Instead of a picture we may also pass a string, but using \TeX by means of `btex-etex` often leads to better results.

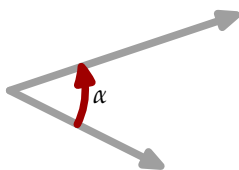

Because in most cases we want the length to be consistent between figures and because passing two paths is more convenient than passing three points, the final definition looks slightly different.

```

numeric anglelength ; anglelength := 20pt ;

vardef anglebetween (expr a, b, str) = % path path string
  save endofa, endofb, common, curve, where ;
  pair endofa, endofb, common ; path curve ; numeric where ;
  endofa := point length(a) of a ;
  endofb := point length(b) of b ;
  if round point 0 of a = round point 0 of b :
    common := point 0 of a ;
  else :
    common := a intersectionpoint b ;
  fi ;
  where := turningnumber (common--endofa--endofb--cycle) ;
  curve := (unitvector (endofa-common){(endofa-common) rotated (where*90)} ..
    unitvector (endofb-common)) scaled anglelength shifted common ;
  draw thefreelabel(str,point .5 of curve,common) withcolor black ;
  curve
enddef ;

```

This macro has a few more if's than its predecessor. First we test if the label is a string, and if so, we calculate the picture ourselves, otherwise we leave this to the user.

```

path a, b, c, d, e, f ;
a := origin--( 2cm, 1cm) ; b := origin--( 1cm, 2cm) ;
c := origin--(-2cm, 2cm) ; d := origin--(-2cm,-1cm) ;
e := origin--(-1cm,-2cm) ; f := origin--( 1cm,-2cm) ;
for i=a, b, c, d, e, f : drawarrow i ; endfor ;
anglelength := 1.0cm ; drawoptions(withcolor .625red) ;
drawarrow      anglebetween(a,b,btex $\alpha $ etex) ;
drawarrow      anglebetween(c,d,btex $\gamma $ etex) ;
drawarrow      anglebetween(e,f,btex $\epsilon$ etex) ;
anglelength := 1.5cm ; drawoptions(withcolor .625yellow) ;
drawdblarrow   anglebetween(b,c,btex $\beta $ etex) ;
drawarrow reverse anglebetween(d,e,btex $\delta $ etex) ;
drawarrow      anglebetween(a,f,btex $\zeta $ etex) ;

```

Because `anglebetween` returns a path, you can apply transformations to it, like reversing. Close reading of the previous code learns that the macro handles both directions.

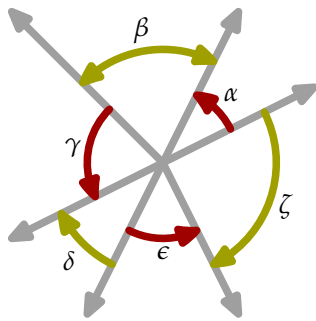

Multiples of 90 degrees are often identified by a rectangular symbol. We will now extend the previously defined macro in such a way that more types can be drawn.

```

numeric anglelength ; anglelength := 20pt ;
numeric anglemethod ; anglemethod := 1 ;

vardef anglebetween (expr a, b, str) = % path path string
  save pointa, pointb, common, middle, offset ;
  pair pointa, pointb, common, middle, offset ;
  save curve ; path curve ;
  save where ; numeric where ;
  if round point 0 of a = round point 0 of b :
    common := point 0 of a ;
  else :
    common := a intersectionpoint b ;
  fi ;
  pointa := point anglelength on a ;
  pointb := point anglelength on b ;
  where := turningnumber (common--pointa--pointb--cycle) ;
  middle := ((common--pointa) rotatedaround (pointa,-where*90))
            intersectionpoint
            ((common--pointb) rotatedaround (pointb, where*90)) ;
  if anglemethod = 1 :
    curve := pointa{unitvector(middle-pointa)}.. pointb ;
    middle := point .5 along curve ;
  elseif anglemethod = 2 :
    middle := common rotatedaround(.5[pointa,pointb],180) ;
    curve := pointa--middle--pointb ;
  elseif anglemethod = 3 :
    curve := pointa--middle--pointb ;
  elseif anglemethod = 4 :
    curve := pointa..controls middle..pointb ;
    middle := point .5 along curve ;
  fi ;
  draw thefreelabel(str, middle, common) withcolor black ;
  curve
enddef ;

```

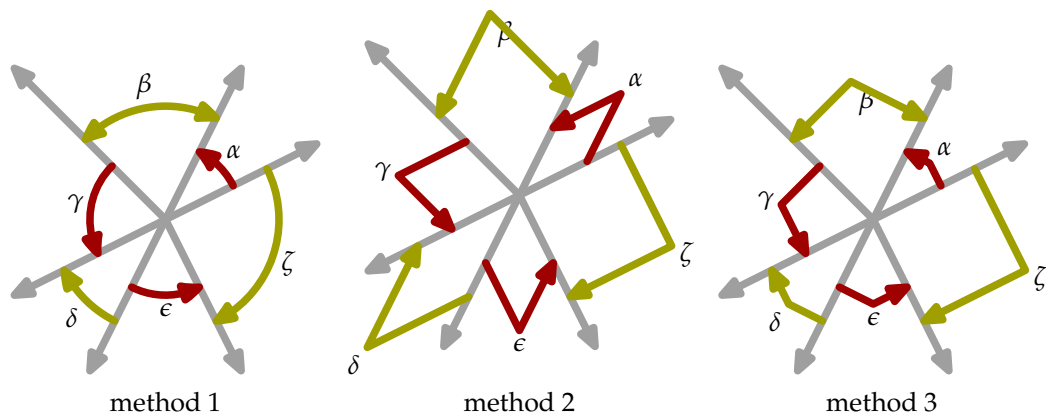

Figure 13.1 Three ways of marking angles.

Figure 13.1 shows the first three alternative methods implemented here. Instead of using `unitvec`s, we now calculate the points using the `arctime` and `arclength` primitives. Instead of complicated expressions, we use the `METAFUN` operators `along` and `on`. The following expressions are equivalent.

```
pointa := point anglelength on a ;
middle := point .5 along curve ;

pointa := point (arctime anglelength of a) of a ;
middle := arctime (.5(arclength curve)) of curve) of curve ;
```

The third method can be implemented in different, more math intensive ways, but the current implementation suits rather well and is understood by the author.

13.4 Color circles

In chapter 3 we showed a few color circles. Drawing such a graphic can be done in several ways, and here we will show a few methods. First we will demonstrate how you can apply `cutafter` and `cutbefore`, next we will show how the `METAPOST` macro `buildpath` can be used, and finally we will present a clean solution using `subpath`. We will assume that the circle is called with the macro:

```
colorcircle (4cm, red, green, blue) ;
```

We need to calculate seven paths. The first implementation does all the handywork itself and thereby is rather long, complicated and unreadable. It does not really use the strength of `METAPOST` yet.

```
vardef colorcircle (expr size, red, green, blue) =
  save r, g, b, rr, gg, bb, cc, mm, yy ;
  save b_r, b_g, g_r, g_b ;
  save radius ;

  path r, g, b, rr, bb, gg, cc, mm, yy ;
  pair b_r, b_g, g_r, g_b ;

  numeric radius ; radius := 3cm ;
```

```

pickup pencircle scaled (radius/20) ;

r := g := b := fullcircle scaled radius shifted (0,radius/4);

r := r rotatedaround(origin, 15) ; % drawarrow r withcolor red ;
g := g rotatedaround(origin,135) ; % drawarrow g withcolor green ;
b := b rotatedaround(origin,255) ; % drawarrow b withcolor blue ;

b_r := b intersectionpoint r ; % draw b_r ;
b_g := b intersectionpoint g ; % draw b_g ;
g_r := reverse g intersectionpoint r ; % draw g_r ;
g_b := reverse g intersectionpoint b ; % draw g_b ;

bb := b cutafter b_r ; bb := bb cutbefore b_g ; % drawarrow bb ;
gg := g cutbefore b_g ; gg := gg cutafter g_r ; % drawarrow gg ;
rr := r cutbefore g_r & r cutafter b_r ; % drawarrow rr ;

cc := b cutbefore b_r ; cc := cc cutafter g_b ; % drawarrow br ;
yy := g cutbefore g_r ; yy := yy cutafter g_b ; % drawarrow rg ;
mm := r cutbefore g_r & r cutafter b_r ; % drawarrow gb ;

bb := gg -- rr -- reverse bb -- cycle ;
gg := bb rotatedaround(origin,120) ;
rr := bb rotatedaround(origin,240) ;

cc := mm -- cc -- reverse yy -- cycle ;
yy := cc rotatedaround(origin,120) ;
mm := cc rotatedaround(origin,240) ;

fill fullcircle scaled radius withcolor white ;

fill rr withcolor red ; fill cc withcolor white-red ;
fill gg withcolor green ; fill mm withcolor white-green ;
fill bb withcolor blue ; fill yy withcolor white-blue ;

for i = rr,gg,bb,cc,mm,yy : draw i withcolor .5white ; endfor ;

currentpicture := currentpicture x sized size ;
enddef ;

```

In determining the right intersection points, you need to know where the path starts and in what direction it moves. In case of doubt, drawing the path as an arrow helps. If you want to see the small paths used, you need to comment the lines with the `fill`'s and uncomment the lines with `draw`'s. Due to the symmetry and the fact that we keep the figure centered around the origin, we only need to calculate two paths since we can rotate them.

There are for sure more (efficient) ways to draw such a figure, but this one demonstrates a few new tricks, like grouping. We use grouping here because we want to use `mm` to indicate the magenta path, and `mm` normally means millimeter. Within a group, you can save variables. These get their old values when the group is left.

With `for` we process multiple paths after each other. In this case it hardly saves tokens, but it looks more clever.

One of the more efficient methods is using the `buildcycle` macro. This macro takes two or more paths and calculates the combined path. Although this is a rather clever macro, you should be prepared to help it a bit when paths have multiple intersection points. Again, we could follow a

more secure mathematical method, but the next one took only a few minutes of trial and error. To save some memory, we redefine the colors graphic.

When we call this macro as:

```
colorcircle(4cm, red, green, blue) ;
```

we get:

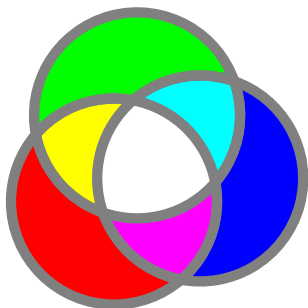

Of course this macro is only used for demonstration purposes and has no real use.

```
vardef colorcircle (expr size, red, green, blue) =
  save r, g, b, rr, gg, bb, cc, mm, yy ; save radius ;
  path r, g, b, rr, bb, gg, cc, mm, yy ; numeric radius ;
  radius := 5cm ; pickup pencircle scaled (radius/25) ;
  r := g := b := fullcircle scaled radius shifted (0,radius/4) ;
  r := r rotatedaround (origin, 15) ;
  g := g rotatedaround (origin,135) ;
  b := b rotatedaround (origin,255) ;
  r := r rotatedaround(center r,-90) ;
  g := g rotatedaround(center g, 90) ;
  gg := buildcycle(buildcycle(reverse r,b),g) ;
  cc := buildcycle(buildcycle(b,reverse g),r) ;
  rr := gg rotatedaround(origin,120) ;
  bb := gg rotatedaround(origin,240) ;
  yy := cc rotatedaround(origin,120) ;
  mm := cc rotatedaround(origin,240) ;
  fill fullcircle scaled radius withcolor white ;
  fill rr withcolor red ; fill cc withcolor white-red ;
  fill gg withcolor green ; fill mm withcolor white-green ;
  fill bb withcolor blue ; fill yy withcolor white-blue ;
  for i = rr,gg,bb,cc,mm,yy : draw i withcolor .5white ; endfor ;
  currentpicture := currentpicture xsized size ;
enddef ;
```

Since we don't want to duplicate a graphic, this time we show the dark alternatives.

```
colorcircle(4cm, .5red, .5green, .5blue) ;
```

This kind of unsafe path calculations are very sensitive to breaking. Changing the radius/4 into something else demonstrates this but we will not challenge this macro that much. Therefore, the 50% color circle shows up as:

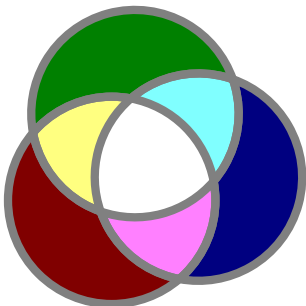

This command is part of METAFUN and can be used to determine nice color combinations by also looking at their complementary colors.

```
colorcircle (4cm, .7red, .5green, .3blue) ;
```

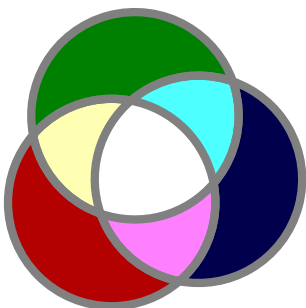

The next circle that we draw shows the three main colors used in this document. This circle is not that beautiful.

```
colorcircle(4cm,.625red,.625yellow,.625white) ;
```

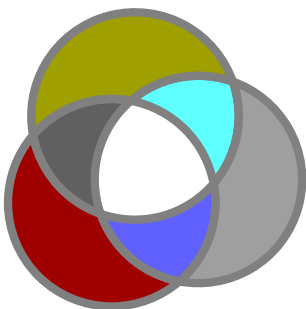

This definition can be cleaned up a bit by using transform, but the fuzzy buildcycle's remain.

```
vardef colorcircle (expr size, red, green, blue) =
  save r, g, b, rr, gg, bb, cc, mm, yy ; save radius ;
  path r, g, b, rr, bb, gg, cc, mm, yy ; numeric radius ;
  radius := 5cm ; pickup pencircle scaled (radius/25) ;
```

```

transform t ; t := identity rotatedaround(origin,120) ;

r := fullcircle scaled radius
  shifted (0,radius/4) rotatedaround(origin,15) ;

g := r transformed t ; b := g transformed t ;

r := r rotatedaround(center r,-90) ;
g := g rotatedaround(center g, 90) ;

gg := buildcycle(buildcycle(reverse r,b),g) ;
cc := buildcycle(buildcycle(b,reverse g),r) ;

rr := gg transformed t ; bb := rr transformed t ;
yy := cc transformed t ; mm := yy transformed t ;

fill fullcircle scaled radius withcolor white ;

fill rr withcolor red ; fill cc withcolor white-red ;
fill gg withcolor green ; fill mm withcolor white-green ;
fill bb withcolor blue ; fill yy withcolor white-blue ;

for i = rr,gg,bb,cc,mm,yy : draw i withcolor .5white ; endfor ;

currentpicture := currentpicture xsized size ;
enddef ;

```

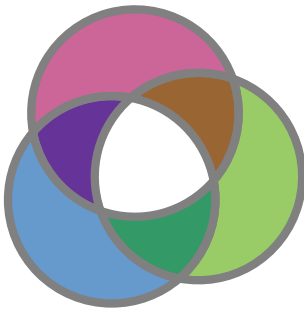

This rather nice circle is defined as:

```
colorcircle(4cm,(.4,.6,.8),(.8,.4,.6),(.6,.8,.4));
```

The final implementation, which is part of METAFUN, is slightly more efficient.

```

vardef colorcircle (expr size, red, green, blue) =
  save r, g, b, c, m, y, w ; save radius ;
  path r, g, b, c, m, y, w ; numeric radius ;

  radius := 5cm ; pickup pencircle scaled (radius/25) ;
  transform t ; t := identity rotatedaround(origin,120) ;

  r := fullcircle rotated 90 scaled radius
    shifted (0,radius/4) rotatedaround(origin,135) ;

  b := r transformed t ; g := b transformed t ;

  c := buildcycle(subpath(1,7) of g, subpath(1,7) of b) ;
  y := c transformed t ; m := y transformed t ;

```

```

w := buildcycle(subpath(3,5) of r,
               subpath(3,5) of g, subpath(3,5) of b) ;

pushcurrentpicture ;

fill r withcolor red ;
fill g withcolor green ;
fill b withcolor blue ;
fill c withcolor white-red ;
fill m withcolor white-green ;
fill y withcolor white-blue ;
fill w withcolor white ;

for i = r,g,b,c,m,y : draw i withcolor .5white ; endfor ;

currentpicture := currentpicture xsized size ;

popcurrentpicture ;
enddef ;

```

Here, we first fill the primary circles, next we fill the secondary ones. These also cover the center, which is why finally we fill the center with white.

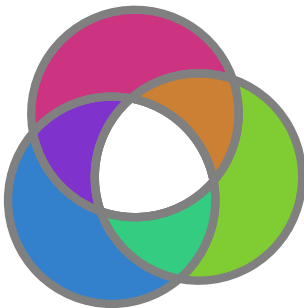

The circle uses the following colors:

```

colorcircle(4cm, (.2, .5, .8), (.8, .2, .5), (.5, .8, .2));

```

The next graphic demonstrates how the subpaths look that build the shapes.

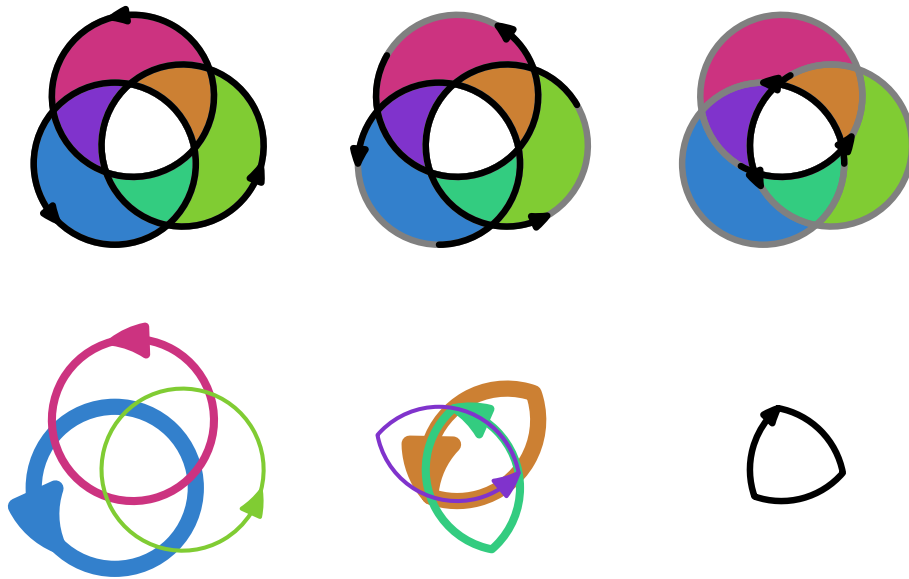

We did not mention what the push and pop commands are responsible for. Scaling the current picture is well defined as long as we deal with one graphic. However, if the current picture already has some content, this content is also scaled. The push and pop commands let us add content to the current picture as well as manipulating the picture as a whole without any side effects. The final result is put on top of the already drawn content. Instead of the sequence:

```
pushcurrentpicture ;
...
currentpicture := currentpicture ... transformations ... ;
popcurrentpicture ;
```

you can say:

```
pushcurrentpicture ;
...
popcurrentpicture ... transformations ... ;
```

Both are equivalent to:

```
draw image ( ... ) ... transformations ... ;
```

For larger sequences of commands, the push–pop alternative gives a bit more more readable code.

13.5 Fool yourself

When doing a literature search on the human perception of black–white edges, I ran into several articles with graphics that I remember having seen before in books on psychology, physiology and/or ergonomics. One of the articles was by Edward H. Adelson of MIT and we will use a few of his example graphics in our exploration to what extent METAPOST can be of help in those disciplines. Since such graphics normally occur in typeset documents, we will define them in the document source.

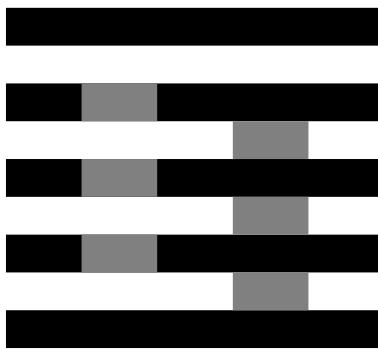

Figure 13.2 White's illusion.

Unless you belong to the happy few whose visual capabilities are not distorted by neural optimizations, in figure 13.2 the gray rectangles at the left look lighter than those on the right. Alas, you can fool yourself, but METAPOST does not cheat. This graphic, referred to as White's illusion, is defined as follows.

```
\startbuffer
interim linecap := butt ; numeric u ; u := 1cm ;
pickup pencircle scaled .5u ;
for i=1u step u until 5u :
  draw (0,i) -- (5u,i) ;
endfor ;
for i=2u step u until 4u :
  draw (u,i) -- (2u,i) withcolor .5white ;
  draw ((3u,i) -- (4u,i)) shifted (0,-.5u) withcolor .5white ;
endfor ;
\stopbuffer
```

Watch how we include the code directly. We have packaged this graphic in a buffer which we include as a floating figure.

```
\placefigure
[here][fig:tricked 1]
{White's illusion.}
{\processMPbuffer}
```

When passed to METAPOST, this code is encapsulated in its `beginfig` and `endfig` macros and thereby grouped. But any change to a variable that is not explicitly saved, migrates to the outer level. In order to prevent all successive graphics to have butt'd linecaps, we have to change this line characteristic locally. Because `linecap` is defined as an internal variable, we have to use `interim` to overload its value. Because `u` is a rather commonly used scratch variable, we don't save its value.

Watch how we use `u` as the loop step. In spite of what your eyes tell you, this graphic only has two explicit color directives, both being 50% black. In the next example we will use some real colors.

In figure 13.3 the small squares in the center of each colored pair of big squares have the same shade, but the way we perceive them are influenced by their surroundings. Both sets of squares are defined using usable graphics. The top squares are defined as:

```
\startuseMPgraphic{second}
\includeMPgraphic{first}
```

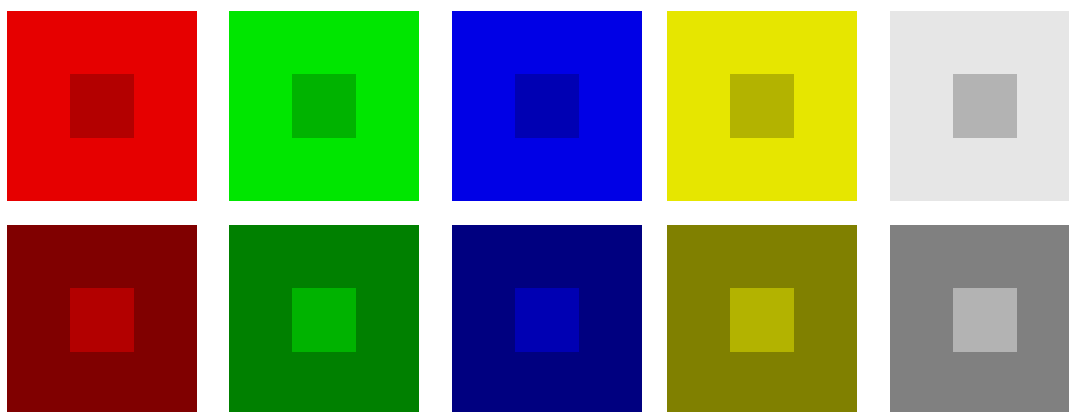

Figure 13.3 The simultaneous contrast effect.

```
fill fullsquare scaled size withcolor topshade ;
fill fullsquare scaled delta withcolor centershade ;
\stopuseMPgraphic
```

and the bottom squares are coded as:

```
\startuseMPgraphic{third}
\includeMPgraphic{first}
fill fullsquare scaled size withcolor bottomshade ;
fill fullsquare scaled delta withcolor centershade ;
\stopuseMPgraphic
```

Because both graphics share code, we have defined that code as a separate graphic, that we include. The only point of interest in this definition is the fact that we let METAPOST interpolate between the two colors using `.5[]`.

```
\startuseMPgraphic{first}
numeric size, delta ;
size := 2.5cm ; delta := size/3 ;
color mainshade, topshade, bottomshade, centershade ;
mainshade := \MPCOLOR{funcolor} ;
topshade := .9mainshade ; bottomshade := .5mainshade ;
centershade := .5[topshade,bottomshade] ;
\stopuseMPgraphic
```

The color `funcolor` is provided by `CONTEXT`, and since we want to use this graphic with different colors, this kind of mapping is quite convenient. The bunch of graphics is packaged in a combination with empty captions. Note how we set the color before we include the graphic.

```
\startcombination[5*2]
{\definecolor[funcolor][red] \useMPgraphic{second}} {}
{\definecolor[funcolor][green] \useMPgraphic{second}} {}
{\definecolor[funcolor][blue] \useMPgraphic{second}} {}
{\definecolor[funcolor][yellow] \useMPgraphic{second}} {}
{\definecolor[funcolor][white] \useMPgraphic{second}} {}
{\definecolor[funcolor][red] \useMPgraphic{third}} {}
{\definecolor[funcolor][green] \useMPgraphic{third}} {}
```

```

{\definecolor[funcolor][blue] \useMPgraphic{third}} {}
{\definecolor[funcolor][yellow]\useMPgraphic{third}} {}
{\definecolor[funcolor][white] \useMPgraphic{third}} {}
\stopcombination

```

We use a similar arrangement for the following graphic, where we have replaced the definitions of first, second and third by new definitions.

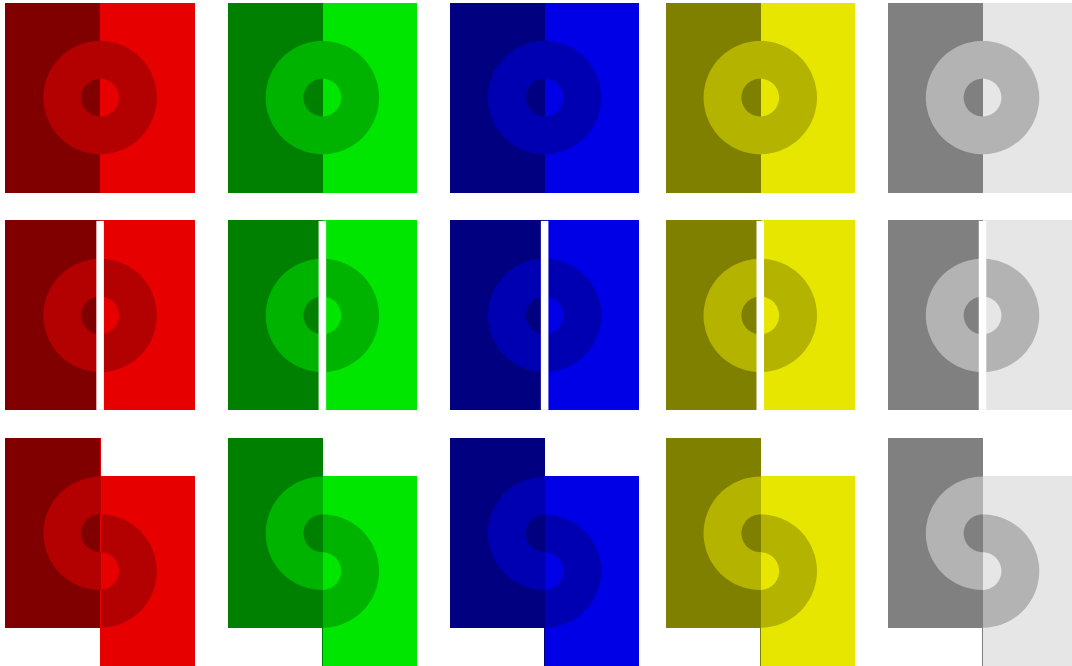

Figure 13.4 Koffka's examples of manipulating contrast by changing the spatial configuration.

The definition of the first row of figure 13.4 is used in the second and third and therefore is the most complicated. We use quite some scratch variables to reach a high level of abstraction. The `yscaled` operator is a `METAFUN` macro.

```

\startuseMPgraphic{first}
  numeric height, width, radius, gap ; gap := 1mm ;
  height = 2.5cm ; width := height/2 ; radius := height/2.5 ;
  color mainshade, leftshade, rightshade, centershade ;
  mainshade := \MPcolor{funcolor} ;
  leftshade := .9mainshade ; rightshade := .5mainshade ;
  centershade := .5[leftshade,rightshade] ;
  fill unitsquare xyscaled ( width,height) withcolor leftshade ;
  fill unitsquare xyscaled (-width,height) withcolor rightshade ;
  draw (fullcircle scaled radius) shifted (0,height/2)
    withpen pencircle scaled (radius/2) withcolor centershade ;
\stopuseMPgraphic

```

The graphics of the second row extends those of the first by drawing a white line through the middle. In this example setting the `linecap` is not really needed, because rounded top and bottoms

in white are invisible and the part that extends beyond the points does not count in calculating the bounding box.

```
\startuseMPgraphic{second}
  \includeMPgraphic{first}
  interim linecap := butt ; pickup pencircle scaled gap ;
  draw (0,0) -- (0,height) withcolor white ;
\stopuseMPgraphic
```

The third row graphics again extend the first graphic. First we copy the picture constructed so far. Watch the double assignment. Next we clip the pictures in half, and shift the right half down over the width of the circle.

```
\startuseMPgraphic{third}
  \includeMPgraphic{first}
  picture p, q ; p := q := currentpicture ;
  clip p to unitsquare xscaled width yscaled height ;
  clip q to unitsquare xscaled -width yscaled height ;
  currentpicture := p ;
  addto currentpicture also q shifted (0,radius/2) ;
\stopuseMPgraphic
```

13.6 Growing graphics

Although METAPOST is not really suited as a simulation engine, it is possible to build graphics that are built and displayed incrementally with a sequence of mouse clicks. The following example is the result of an email discussion David Arnold and the author had while METAFUN evolved.

Instead of defining the graphics in a separate METAPOST file, we will incorporate them in the document source in which they are used. We can use several methods.

1. Define macros and figures in a separate file and include the graphics as external graphics.
2. Define everything in the document source as usable graphics and include the graphics using `\useMPgraphic`.
3. Package the graphic components in buffers and paste those together as graphics that can be processed at run time.

The first method is the most independent one, which has its advantages if we want to use the graphics in other applications too. The second method works well in graphics where parts of the definitions change between invocations of the graphic. This method follows the template:

```
\startuseMPgraphic{whatever}
  ...
\stopuseMPgraphic

\startuseMPgraphic{result}
  ...
  \includeMPgraphic{whatever}
  ...
\stopuseMPgraphic
```

```
\useMPgraphic{result}
```

The disadvantage of this method is that it cannot be combined with `btex–etex` since it is nearly impossible to determine when, how, and to what extent the content of a graphic should be expanded before writing it to the temporary METAPOST file.

Therefore, we will demonstrate how buffers can be used. This third method closely parallels the first way of defining graphics. A nice side effect is that we can easily typeset these buffers verbatim, which we did to typeset this document.

We are going to do a classic compass and straightedge construction, the bisection of a line segment joining two arbitrary points. We will construct five graphics, where each one displays one step of the construction. We will embed each graphic in a `start–stop` command. Later we will see the advantage of this strategy.

```
\startbuffer[a]
def start_everything = enddef ;
def stop_everything = enddef ;
\stopbuffer
```

We are going to draw a few dots, and to force consistency we first define a macro `draw_dot`. The current step will be highlighted in red using `stand_out`.

```
\startbuffer[b]
numeric u, w ; u := .5cm ; w := 1pt ;
pickup pencircle scaled w ;
def draw_dot expr p =
  draw p withpen pencircle scaled 3w ;
enddef ;
def stand_out =
  drawoptions(withcolor .625red) ;
enddef ;
\stopbuffer
```

First, we construct the macro that will plot two points *A* and *B* and connect them with a line segment.

```
\startbuffer[c]
def draw_basics =
  pair pointA, pointB ; path lineAB ;
  pointA := origin ; pointB := pointA shifted (5u,0) ;
  lineAB := pointA -- pointB ;
  draw lineAB ;
  draw_dot pointA ; label.lft(btex A etex, pointA) ;
  draw_dot pointB ; label.rt (btex B etex, pointB) ;
enddef ;
\stopbuffer
```

The code in this buffer executes the preceding macros. The `..._everything` commands are still undefined, but later we can use these hooks for special purposes.

```
\startbuffer[1]
```

```

start_everything ;
  stand_out ; draw_basics ;
stop_everything ;
\stopbuffer

```

This graphic can now be embedded by the `CONTEXT` command `\processMPbuffer`. This command, like the ordinary buffer inclusion commands, accepts a list of buffers.

```

\startlinecorrection[blank]
\ruledhbox{\processMPbuffer[a,b,c,1]}
\stoplinecorrection

```

We use `\ruledhbox` to show the tight bounding box of the graphic. The line correction takes care of proper spacing around non textual content, like graphics.¹⁵ This is only needed when the graphic is part of the text flow!



Next, we draw two circles of equal radius, one centered at point *A*, the other at point *B*.

```

\startbuffer[d]
def draw_circles =
  path circleA, circleB ; numeric radius, distance ;
  distance := (xpart pointB) - (xpart pointA) ;
  radius := 2/3 * distance ;
  circleA := fullcircle scaled (2*radius) ;
  circleB := circleA shifted pointB ;
  draw circleA ;
  draw circleB ;
enddef ;
\stopbuffer

```

As you can see, we move down the `stand_out` macro so that only the additions are colored red.

```

\startbuffer[2]
start_everything ;
  draw_basics ; stand_out ; draw_circles ;
stop_everything ;
\stopbuffer

```

We now use `\processMPbuffer[a,b,c,d,2]` to include the latest step.

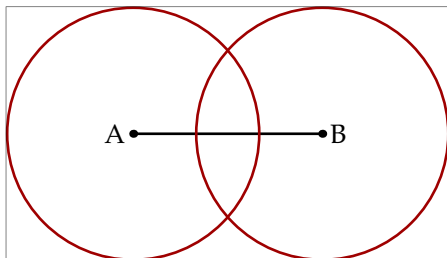

¹⁵ These spacing commands try to get the spacing around the content visually compatible, and take the height and depth of the preceding and following text into account.

The next step in the construction of the perpendicular bisector requires that we find and label the points of intersection of the two circles centered at points A and B . The intersection points are calculated as follows. Watch the reverse operation, which makes sure that we get the second intersection point.

```
\startbuffer[e]
def draw_intersection =
  pair pointC, pointD ;
  pointC := circleA intersectionpoint circleB ;
  pointD := (reverse circleA) intersectionpoint (reverse circleB) ;
  draw_dot pointC ; label.lft(btex C etex, pointC shifted (-2w,0)) ;
  draw_dot pointD ; label.lft(btex D etex, pointD shifted (-2w,0)) ;
enddef ;
\stopbuffer
```

In placing the label, we must make sure that the text runs free of the lines and curves. Again, move the `stand_out` macro just prior to `draw_intersection` macro, so that this step is highlighted in the drawing color, while prior steps are drawn in the default color (in this case black).

```
\startbuffer[3]
start_everything ;
  draw_basics ; draw_circles ; stand_out ; draw_intersection ;
stop_everything ;
\stopbuffer
```

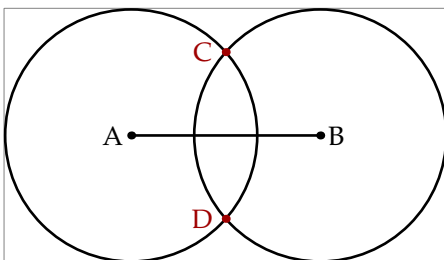

The line drawn through points C and D will be the perpendicular bisector of the line segment connecting points A and B . In the next step we will draw a line using the plain METAPOST `drawdblarrow` macro that draws arrowheads at each end of a path.

```
\startbuffer[f]
def draw_bisector =
  path lineCD ;
  lineCD := origin -- origin shifted (2*distance,0) ;
  lineCD := lineCD rotated 90 shifted 0.5[pointA,pointB] ;
  lineCD := lineCD shifted (0,-distance) ;
  drawdblarrow lineCD ;
enddef ;
\stopbuffer

\startbuffer[4]
start_everything ;
  draw_basics ; draw_circles ; draw_intersection ; stand_out ;
  draw_bisector ;
```

```
stop_everything ;
\stopbuffer
```

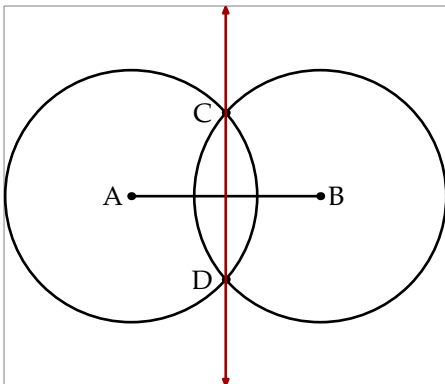

The following code draws the intersection of line $C - D$ and line segment $A - B$, which can be shown to be the midpoint of segment $A - B$.

```
\startbuffer[g]
def draw_midpoint =
  pair pointM ;
  pointM := lineCD intersectionpoint lineAB ;
  draw_dot pointM ; label.llft(btex M etex, pointM) ;
enddef ;
\stopbuffer

\startbuffer[5]
start_everything ;
  draw_basics ; draw_circles ; draw_intersection ; draw_bisector ;
  stand_out ; draw_midpoint ;
stop_everything ;
\stopbuffer
```

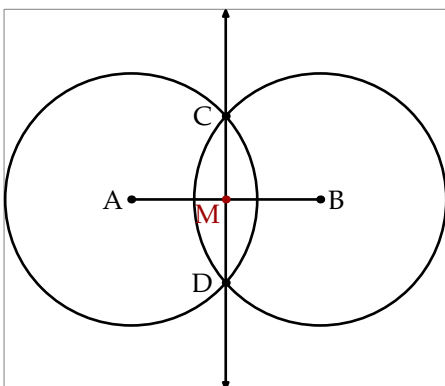

As long as we place the graphics as individual insertions in our document, everything is fine. However, if we wish to place them all at once, or as we shall see later, place them on top of one another in a fieldstack, it makes sense to give them all the same bounding box. We can do this by completing the `start_everything` and `stop_everything` commands.

```
\startbuffer[a]
```



```

def start_everything =
  path bb ;
  draw_basics ;
  draw_circles ;
  draw_intersection ;
  draw_bisector ;
  draw_midpoint ;
  bb := boundingbox currentpicture ;
  currentpicture := nullpicture ;
enddef ;

def stop_everything =
  setbounds currentpicture to bb ;
enddef ;
\stopbuffer

```

In figure 13.5 we demonstrate the effect of this redefinition. For this purpose we scale down the graphic to a comfortable 40%, of course by using an additional buffer. We also visualize the bounding box.

```

\startbuffer[h]
def stop_everything =
  setbounds currentpicture to bb ;
  draw bb withpen pencircle scaled .5pt withcolor .625yellow ;
  currentpicture := currentpicture scaled .4 ;
enddef ;
\stopbuffer

```

The graphic itself is defined as follows. Watch how we use the default buffer to keep the definitions readable.

```

\startbuffer
\startcombination[5*1]
  {\processMPbuffer[a,b,c,h,d,e,f,g,1]} {step 1}
  {\processMPbuffer[a,b,c,h,d,e,f,g,2]} {step 2}
  {\processMPbuffer[a,b,c,h,d,e,f,g,3]} {step 3}
  {\processMPbuffer[a,b,c,h,d,e,f,g,4]} {step 4}
  {\processMPbuffer[a,b,c,h,d,e,f,g,5]} {step 5}
\stopcombination
\stopbuffer

\placefigure
  [here][fig:1 till 5]
  {The five graphics, each with the same bounding box.}
  {\getbuffer}

```

As the original purpose of these graphics was not to show them side by side, but to present them as field stack in a document to be viewed at the computer screen. For this purpose we have to define the graphics as symbols.

```

\definesymbol[step 1][{\processMPbuffer[a,b,c,d,e,f,g,1]}]
\definesymbol[step 2][{\processMPbuffer[a,b,c,d,e,f,g,2]}]

```

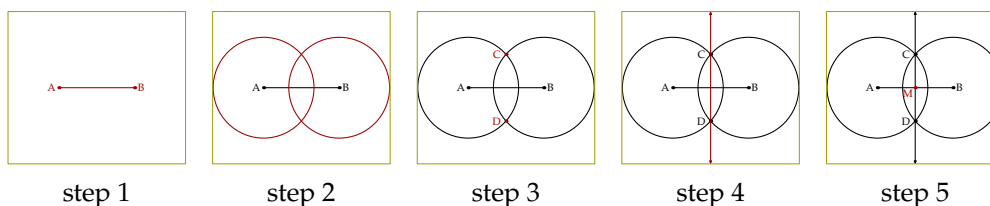

Figure 13.5 The five graphics, each with the same bounding box.

```
\definesymbol [step 3] [{\processMPbuffer [a,b,c,d,e,f,g,3]}]
\definesymbol [step 4] [{\processMPbuffer [a,b,c,d,e,f,g,4]}]
\definesymbol [step 5] [{\processMPbuffer [a,b,c,d,e,f,g,5]}]
```

A field stack is a sequence of overlaid graphics. We will arrange these to cycle manually, with clicks of the mouse, through the sequence of graphs depicting the construction of the midpoint of segment $A - B$. So, in fact we are dealing with a manual simulation. The definition of such a stack is as follows:

```
\definefieldstack
  [midpoint construction]
  [step 1, step 2, step 3, step 4, step 5]
  [frame=on,offset=3pt,framecolor=darkyellow,rulethickness=1pt]
```

The first argument is to be a unique identifier, the second argument takes a list of symbols, while the third argument accepts settings. More on this command can be found in the `CONTEXT` manuals.

The stack is shown as figure 13.6. Its caption provides a button, which enables the reader to cycle through the stack. We call this a stack because the graphics are positioned on top of each other. Only one of them is visible at any time.

```
\placefigure
  [here] [fig:steps]
  {Bisecting a line segment with compass and straightedge? Just
   click \goto {here} [JS(Walk_Field{midpoint construction})] to
   walk through the construction! (This stack is only visible
   in a \PDF\ viewer that supports widgets.)}
  {\framed{\startoverlay
    {\symbol [step 1]}
    {\fieldstack [midpoint construction]}
    \stopoverlay}}
```

We cheat a bit and overlay the stack over the first symbol because otherwise nothing shows up in print (nowadays I mostly use `sumatrapdf`).

At the start of this section, we mentioned three methods. When we use the first method of putting all the graphics in an external `METAPOST` file, the following framework suits. We assume that the file is called `step.mp` and that it is kept by the user along with his document source. We start with the definitions of the graphic steps. These are the same as the ones shown previously.

```
def draw_basics      = ... endif ;
def draw_circles     = ... endif ;
def draw_intersection = ... endif ;
def draw_bisector    = ... endif ;
```

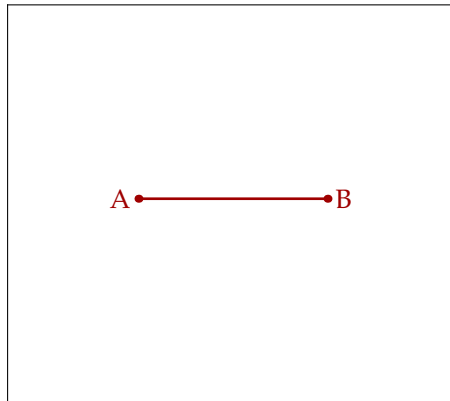

Figure 13.6 Bisecting a line segment with compass and straightedge? Just click [here](#) to walk through the construction! (This stack is only visible in a PDF viewer that supports widgets.)

```
def draw_midpoint      = ... endif ;
def stand_out         = ... endif ;
```

We can save some code by letting the `..._everything` take care of the `beginfig` and `endfig` macros.

```
def start_everything (expr n) = beginfig(n) ; ... endif ;
def stop_everything      = ... ; endfig ; endif ;
```

The five graphics now become:

```
start_everything (1) ;
  stand_out ; draw_basics ;
stop_everything ;

start_everything (2) ;
  draw_basics ; stand_out ; draw_circles ;
stop_everything ;

start_everything (3) ;
  draw_basics ; draw_circles ; stand_out ; draw_intersection ;
stop_everything ;

start_everything (4) ;
  draw_basics ; draw_circles ; draw_intersection ; stand_out ;
  draw_bisector ;
stop_everything ;

start_everything (5) ;
  draw_basics ; draw_circles ; draw_intersection ; draw_bisector ;
  stand_out ; draw_midpoint ;
stop_everything ;
```

The definitions of the symbols now refer to an external figure.

```

\definesymbol[step 1][{\externalfigure[step.1]}]
\definesymbol[step 2][{\externalfigure[step.2]}]
\definesymbol[step 3][{\externalfigure[step.3]}]
\definesymbol[step 4][{\externalfigure[step.4]}]
\definesymbol[step 5][{\externalfigure[step.5]}]

```

Which method is used, depends on the way the graphics are used. In this example we wanted to change the definition of `..._everything`, so here the third method was quite useful.

13.7 Simple Logos

Many company logos earn their beauty from their simplicity. One of the logos that most Dutch people have imprinted in their mind is that of the Dutch Railway Company (NS). An interesting feature of this logo is that, although it is widely known, drawing it on a piece of paper from mind is a task that many people fail.

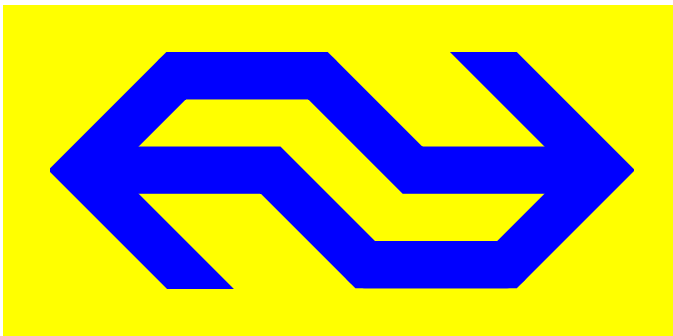

This logo makes a good candidate for demonstrating a few fine points of drawing graphics, like using linear equations, setting line drawing characteristics, clipping and manipulating bounding boxes.

The implementation below is quite certainly not according to the official specifications, but it can nevertheless serve as an example of defining such logos.

As always, we need to determine the dimensions first. Here, both the height and line width depend on the width of the graphic.

Instead of calculating the blue shape such that it will be a filled outline, we will draw the logo shape using line segments. This is why we need the `line` parameter.

```

numeric width ; width = 3cm ;
numeric height ; height = width/2 ;
numeric line ; line = height/4 ;

```

We want sharp corners which can be achieved by setting `linejoin` to `mitered`.

```

linejoin := mitered ; pickup pencircle scaled line ;

```

The colors are rather primary blue and yellow. At the time of writing this manual, Dutch trains are still painted yellow, so we will use that shade as background color.

```

color nsblue ; nsblue := (0,0,1) ;
color nsyellow ; nsyellow := (1,1,0) ;

```

We will now describe the main curves. Although these expressions are not that advanced, they demonstrate that we can express relationships instead of using assignments.

```
z1 = (0, height/2) ;
z2 = (width/2-height/4, y1) ;
z3 = (width/2+height/4, y4) ;
z4 = (width, 0) ;

path p ; p := z1--z2--z3--z4 ;
```

Although it is accepted to consider z to be a variable, it is in fact a `vardef` macro, that expands into a pair (x,y) . This means that the previous definitions internally become:

```
(x1,y1) = (0, height/2) ;
(x2,y2) = (width/2-height/4, y1) ;
(x3,y3) = (width/2+height/4, y4) ;
(x4,y4) = (width, 0) ;
```

These 8 relations can be solved by METAPOST, since all dependencies are known.

```
x1 = 0 ; y1 = height/2 ;
x2 = width/2-height/4 ; y2 = y1 ;
x3 = width/2+height/4 ; y3 = y4 ;
x4 = width ; y4 = 0 ;
```

Since we express the variables x and y in terms of relations, we cannot reuse them, because that would mean that inconsistent relations occur. So, the following lines will lead to an error message:

```
z1 = (10,20) ; z1 = (30,50) ;
```

For similar reasons, we may not assign a value (using `:=`) to such a z variable. Within a METAPOST figure, z variables are automatically saved, which means that they can be reused for each figure.

So far, we have defined the following segment of the logo.



The next expressions are used to define the second segment. The third expression determines $z7$ to be positioned on the line $z5--z6$, where we extend this line by 50%.

```
z5 = (x4+height/2, y1) ;
z6 = (x4, 2y1) ;
z7 = 1.5[z5,z6] ;

path q ; q := z3--z4--z5--z7 ;
```

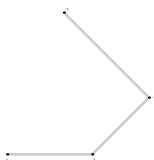

If we combine these two segments, we get:

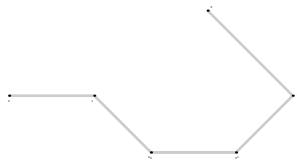

However, when we draw them using the right linewidth and color, you will notice that we're not yet done:

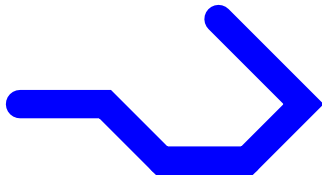

The second curve is similar to the first one, but rotated over 180 degrees.

```
addto currentpicture also currentpicture
  rotatedaround (.5[z2,z3],180) shifted (height/4,height/2) ;
```

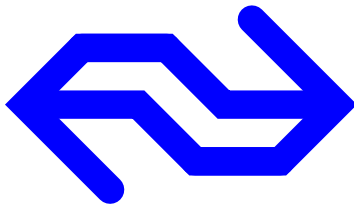

In order to get the sharp edges, we need to clip off part of the curves and at first sight, we may consider using a scaled bounding box. However, when we show the natural bounding box, you will notice that a more complicated bit of calculations is needed.

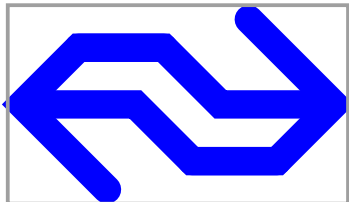

The right clip path is calculated using the following expressions. Watch how we use `rt` and `top` to correct for the linewidth.

```
numeric d, lx, ly, ux, uy ; d = line/2 ;
lx = -3d - d/3 ; ly = -d ; ux = rt x5 + d/3 ; uy = top y6 ;
path r ; r := (lx,ly)--(ux,ly)--(ux,uy)--(lx,uy)--cycle;
```

The clipping path is applied by saying:

```
clip currentpicture to r ;
```

The result is quite acceptable:

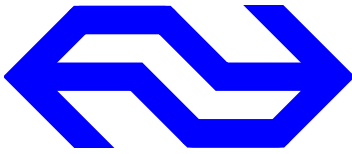

But, if you watch closely to how this graphic extends into to left margin of this document, you will see that the bounding box is not yet right.

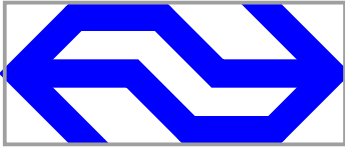

```
setbounds currentpicture to r ;
```

We use the same path `r` to correct the bounding box.

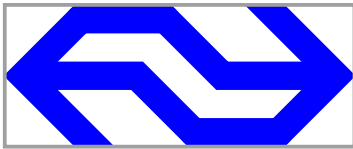

There are a few subtle points involved, like setting the `linejoin` variable. If we had not set it to `mitered`, we would have got round corners. We don't set the `linecap`, because a flat cap would not extend far enough into the touching curve and would have left a small hole. The next example shows what happens if we set these variables to the wrong values:

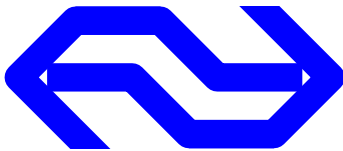

In fact we misuse the fact that both curves overlay each other.

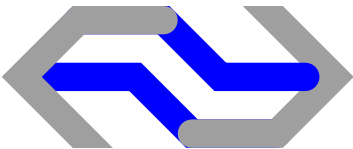

The complete logo definition is a bit more extensive because we also want to add a background. Because we need to clip the blue foreground graphic, we must temporarily store it when we fill the background.

```
numeric width, height, line, delta ;
width = 5cm ; height = width/2 ; line = height/4 ; delta = line ;

linejoin := mitered ; pickup pencircle scaled line ;

color nsblue   ; nsblue   := (0,0,1) ;
color nsyellow ; nsyellow := (1,1,0) ;

z1 = (0, height/2) ;
z2 = (width/2-height/4, y1) ;
```

```

z3 = (width/2+height/4, y4) ;
z4 = (width, 0) ;

z5 = (x4+height/2, y1) ;
z6 = (x4, 2y1) ;
z7 = 1.5[z5,z6] ;

path p ; p := z1--z2--z3--z4 ; path q ; q := z3--z4--z5--z7 ;
numeric d, lx, ly, ux, uy ; d = line/2 ;
lx = -3d - d/3 ; ly = -d ; ux = rt x5 + d/3 ; uy = top y6 ;
path r ; r := (lx,ly)--(ux,ly)--(ux,uy)--(lx,uy)--cycle;
lx := lx-delta ; ly := ly-delta ; ux := ux+delta ; uy := uy+delta ;
path s ; s := (lx,ly)--(ux,ly)--(ux,uy)--(lx,uy)--cycle;
draw p withcolor nsblue ; draw q withcolor nsblue ;
addto currentpicture also currentpicture
  rotatedaround (.5[z2,z3],180) shifted (height/4,height/2) ;
picture savedpicture ; savedpicture := currentpicture ;
clip currentpicture to r ;
setbounds currentpicture to r ;
savedpicture := currentpicture ; currentpicture := nullpicture ;
fill s withcolor nsyellow ;
addto currentpicture also savedpicture ;

```

For practical use it makes sense to package this definition in a macro to which we pass the dimensions.

13.8 Music sheets

The next example demonstrates quite some features. Imagine that we want to make us a couple of sheets so that we can write a musical masterpiece. Let's also forget that \TeX can draw lines, which means that somehow we need to use \METAPOST .

Drawing a bar is not that complicated as the following code demonstrates.

```

\startusableMPgraphic{bar}
  vardef MusicBar (expr width, gap, linewidth, barwidth) =
    image
      ( interim linecap := butt ;
        for i=1 upto 5 :
          draw ((0,0)--(width,0)) shifted (0,(i-1)*gap)
            withpen pencircle scaled linewidth ;
        endfor ;
        for i=llcorner currentpicture -- ulcorner currentpicture ,
          lrcorner currentpicture -- urcorner currentpicture :
          draw i withpen pencircle scaled barwidth ;
        endfor ; )

```



```

    \enddef ;
\stopusableMPgraphic

```

We can define the sidebars a bit more efficient using two predefined subpaths:

```

for i=leftboundary currentpicture, rightboundary currentpicture :

```

We define a macro `MusicBar` that takes four arguments. The first two determine the dimensions, the last two concern the line widths. Now watch how we can use this macro:

```

\includeMPgraphic{bar} ;
draw MusicBar (200pt, 6pt, 1pt, 2pt) ;
draw MusicBar (300pt, 6pt, 1pt, 2pt) shifted (0,-30pt) ;

```

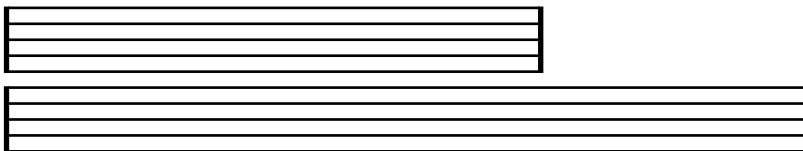

As you can see in this example, the bar is a picture that can be transformed (shifted in our case). However, a close look at the macro teaches us that it does a couple of draws too. This is possible because we wrap the whole in an image using the `image` macro. This macro temporarily saves the current picture, and at the end puts the old `currentpicture` under the new one.

We wrap the whole in a `vardef`. This means that the image is returned as if it was a variable. Actually, the last thing in a `vardef` should be a proper return value, in our case a picture. This also means that we may not end the `vardef` with a semi colon. So, when the content of the `vardef` is expanded, we get something

```

draw some_picture ... ;

```

Because we are still drawing something, we can add transform directives and set attributes, like the color.

The second `for` loop demonstrates two nice features. Instead of repeating the draw operation by copying code, we apply it to a list, in our case a list of paths. This list contains two simple line paths. Because an `image` starts with a fresh `currentpicture`, we can safely use the bounding box data to determine the height of the line.

The next step in producing the sheets of paper is to put several bars on a page, preferable with the width of the current text. This time we will use a reusable graphic, because each bar is the same.

```

\startreusableMPgraphic{bars}
  \includeMPgraphic{bar} ;
  draw MusicBar (TextWidth, 6pt, 1pt, 2pt) withcolor .625yellow ;
\stopreusableMPgraphic

```



Instead of going through the trouble of letting `METAPOST` calculate the positions of the bars, we will use `TEX`. We put 12 bars on a page and let `TEX` take care of the inter-bar spacing. Because we only want stretchable space between bars, called `glue` in `TEX`, we need to remove the last added glue.

```

\startstandardmakeup[doublesided=no,page=]
  \dorecurse{15}{\reuseMPgraphic{bars}\vfill}\removeatlastskip
\stopstandardmakeup

```

It may add to the atmosphere of handy-work if you slightly randomize the lines. We leave it up to the reader to figure out how the code should be changed to accomplish this.



The complete result is shown on the next page.

13.9 The euro symbol

When Patrick Gundlach posted a nice METAPOST version of the euro symbol to the CONTEXT discussion list, he added the comment “The official construction is ambiguous: how thick are the horizontal bars? How much do they stick out to the left? Is this thing a circle or what? Are the angles on the left side of the bars the same as the one on the right side? . . .” The alternative below is probably not as official as his, but permits a finetuning. You are warned: whatever you try, the euro *is* and *will remain* an ugly symbol.

We use a couple of global variables to control the euro shape within reasonable bounds. Then we define two circles. Next we define a vertical line that we use in a couple of cut and paste operations. Watch how the top left point of the outer circle determines the slant of the line that we use to slice the vertical bars.

```

boolean trace_euro ; trace_euro := false ;

vardef euro_symbol = image ( % begin_of_euro

if unknown euro_radius   : euro_radius   := 2cm           ; fi ;
if unknown euro_width    : euro_width    := 3euro_radius/16 ; fi ;
if unknown euro_r_offset : euro_r_offset := euro_width     ; fi ;
if unknown euro_l_offset : euro_l_offset := euro_radius/32 ; fi ;
if unknown euro_l_shift  : euro_l_shift  := euro_r_offset   ; fi ;
if unknown euro_v_delta  : euro_v_delta  := euro_width/4    ; fi ;

save
  outer_circle, inner_circle, hor_bar,
  right_line, right_slant, top_slant, bot_slant,
  euro_circle, euro_topbar, euro_botbar ;

path
  outer_circle, inner_circle, hor_bar,
  right_line, right_slant, top_slant, bot_slant,
  euro_circle, euro_topbar, euro_botbar ;

outer_circle := fullcircle scaled euro_radius ;
inner_circle := fullcircle scaled (euro_radius-euro_width) ;

if trace_euro : for i = outer_circle, inner_circle :
  draw i withpen pencircle scaled 1pt withcolor .5white ;
endfor ; fi ;

```

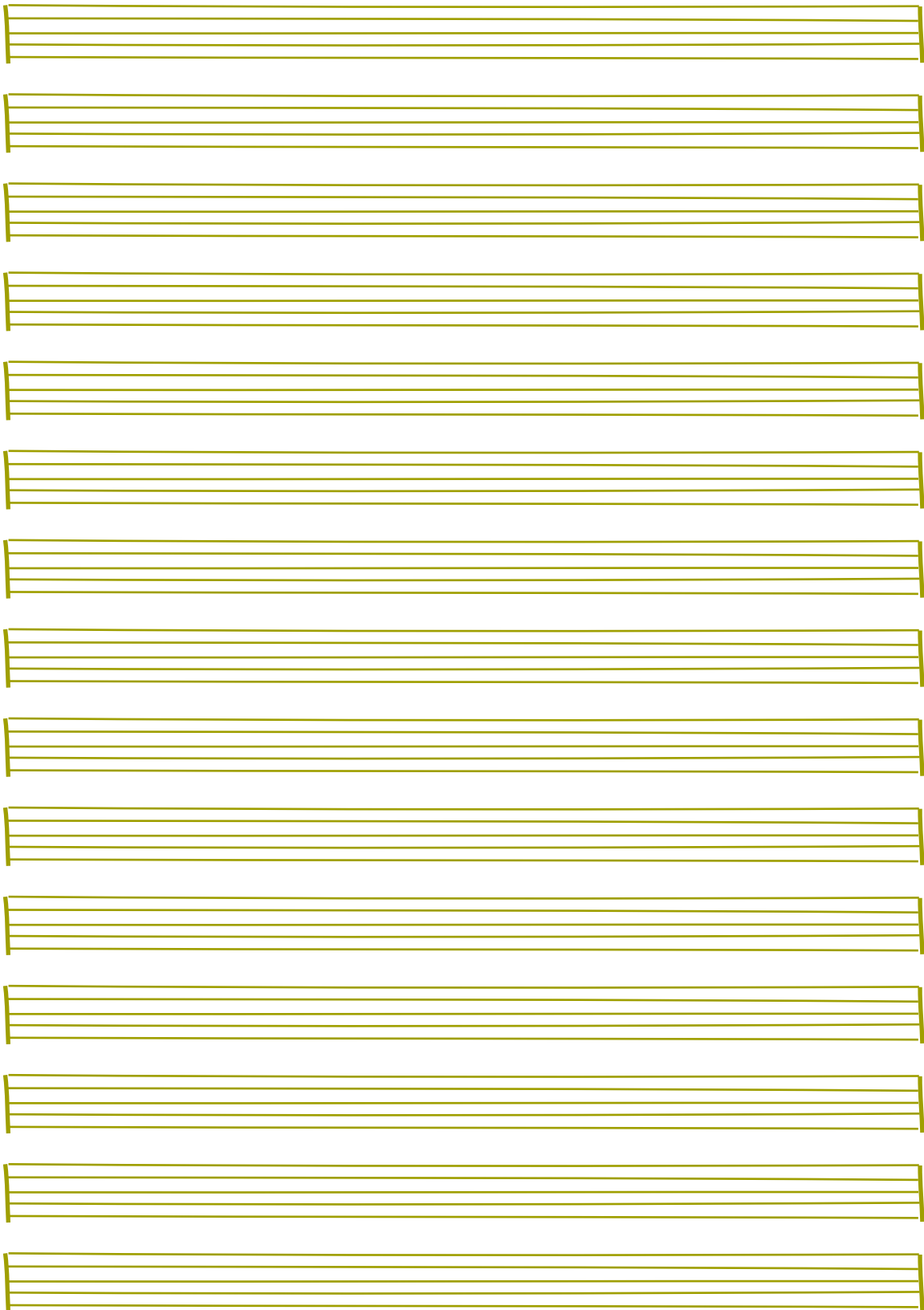

```

right_line :=
  (lrcorner outer_circle -- urcorner outer_circle)
  shifted (-euro_r_offset,0) ;

outer_circle := outer_circle cutbefore right_line ;

right_slant :=
  point 0 of outer_circle
  -- origin shifted (0,ypart lrcorner outer_circle) ;

euro_circle := buildcycle(outer_circle, right_line,
  reverse inner_circle, reverse right_slant) ;

hor_bar := (-euro_radius,0) -- (euro_radius,0) ;

top_slant :=
  right_slant shifted (-euro_radius+euro_r_offset-euro_l_offset,0) ;

bot_slant :=
  top_slant shifted (0,-euro_l_shift) ;

if trace_euro : for i = right_line, right_slant, top_slant, bot_slant :
  draw i withpen pencircle scaled 1pt withcolor .5white ;
endfor ; fi ;

euro_topbar := buildcycle
  (top_slant, hor_bar shifted (0, euro_v_delta),
  right_slant, hor_bar shifted (0, euro_v_delta+euro_width/2)) ;

euro_botbar := buildcycle
  (bot_slant, hor_bar shifted (0,-euro_v_delta),
  right_slant, hor_bar shifted (0,-euro_v_delta-euro_width/2)) ;

for i = euro_circle, euro_topbar, euro_botbar :
  draw i withpen pencircle scaled 0 ;
endfor ;
for i = euro_circle, euro_topbar, euro_botbar :
  fill i withpen pencircle scaled 0 ;
endfor ;

if trace_euro :
  drawpoints euro_circle withcolor red ;
  drawpoints euro_topbar withcolor green ;
  drawpoints euro_botbar withcolor blue ;
fi ;

) enddef ; % end_of_euro

```

We only set a parameter when it is not yet set. This has the advantage that we don't have to set them when we change one. This way of manipulating paths (cutting and building) does not always work well because of rounding errors, but here it does work.

```
euro_radius := 4cm ; trace_euro := true ; draw euro_symbol ;
```

For educational purposes, we have added a bit of tracing. When enabled, the euro shows up as:

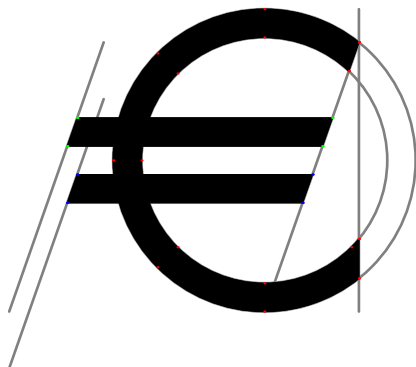

Of course it would be best to define the euro as one shape, but we won't go through that process right now. By packaging the combined paths in an image, we can conveniently color the euro symbol:

```
draw euro_symbol withcolor .625red ;
```



You may wonder why we both draw and fill the euro, using a pen with zero width. We've done this in order to demonstrate the `redraw` and `refill` macros.

```
redraw currentpicture withpen pencircle scaled 4pt withcolor .625yellow ;
refill currentpicture withcolor .625white ;
setbounds currentpicture to boundingbox currentpicture enlarged 2pt ;
```



13.10 Killing time

Not seldom \TeX users want to use this program and its meta-relatives as general purpose tools, even at the cost of quite some effort or suboptimal results. Imagine that you are under way from our planet to Mars. After a long period of sleep you wake up and start wondering on what track

you are. You even start questioning the experts that send you on your way, so you pop open your laptop, launch your editor and start metaposting.

First you need to determine the begin and end points of your journey. For now it is enough to know the relative angle of the paths that both planets follow as well as the path themselves. We assume circular paths.

```
path a ; a := fullcircle scaled 3cm ;
path b ; b := fullcircle scaled 2cm rotated 120 ;

draw a withpen pencircle scaled 1mm withcolor .625red ;
draw b withpen pencircle scaled 1mm withcolor .625yellow ;

draw point 0 of a withpen pencircle scaled 2mm ;
draw point 0 of b withpen pencircle scaled 2mm ;
```

The rotation 120 can be calculated from the relative starting points and time the journey will take. Alternatively we can use the time along the path, but this would be a bit more fuzzy later on.¹⁶

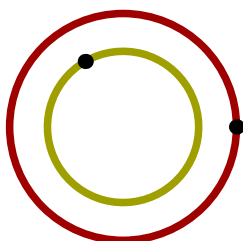

After a bit of playing with drawing paths between the two points, you decide to make a macro. We want to feed the angle between the paths but also the connecting path. So, we have to pass a path, but unfortunately we don't have direct access to the points. By splitting the argument definition we can pass an expression first, and a wildcard argument next.

```
\startuseMPgraphic{gamble}
def Gamble (expr rot) (text track) =
  path a ; a := fullcircle scaled 3cm ;
  path b ; b := fullcircle scaled 2cm rotated rot ;

  pair aa ; aa := point 0 of a ;
  pair bb ; bb := point 0 of b ;
  path ab ; ab := track ;

  draw a withpen pencircle scaled 1mm withcolor .625red ;
  draw b withpen pencircle scaled 1mm withcolor .625yellow ;

  draw aa withpen pencircle scaled 2mm ;
  draw bb withpen pencircle scaled 2mm ;

  drawarrow ab withpen pencircle scaled 1mm withcolor .625white ;

  setbounds currentpicture to boundingbox a enlarged 2mm ;
  draw boundingbox currentpicture withpen pencircle scaled .25mm ;
enddef ;
\stopuseMPgraphic
```

¹⁶ In case you wonder why METAPOST talks about the time on a path, you now have a cue.

Because at this distance nobody will bother us with the thickness of the pen and colors, we code them the hard way. We create our own universe by setting a fixed boundingbox.

We leave the Earth in the most popular way, straight upwards and after a few cycles, we leave it parallel to the surface. The path drawn reminds much of the trajectories shown in popular magazines.

```
\startMPcode
\includeMPgraphic{gamble} ;
Gamble(120, aa {(0,1)} .. bb) ;
\stopMPcode
```

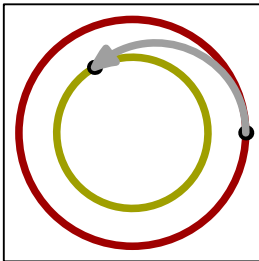

According to METAPOST, when we leave the Earth straight upwards and want a smooth trajectory, we have to pass through outer space.

```
\startMPcode
\includeMPgraphic{gamble} ;
Gamble(120,aa {(1,0)} .. bb) ;
\stopMPcode
```

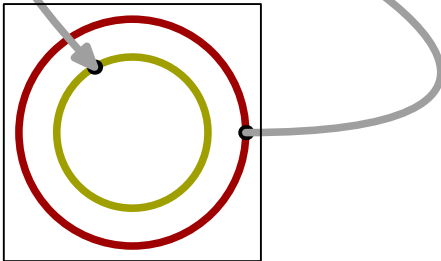

Given that we want a smooth path as well as a short journey, we can best follow Mars' path. Here we face the risk that when we travel slower than Mars does, we have a problem.

```
\startMPcode
\includeMPgraphic{gamble} ;
Gamble(120,aa {dir 90} .. {precontrol 0 of b rotated 90} bb) ;
\stopMPcode
```

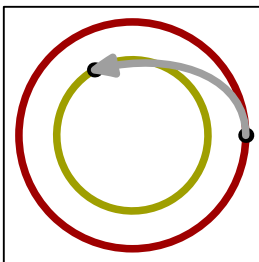

We can even travel a shorter path when we leave Earth at the surface that faces the point of arrival.

```
\startMPcode
\includeMPgraphic{gamble} ;
Gamble(120,aa .. {precontrol 0 of b rotated 90} bb) ;
\stopMPcode
```

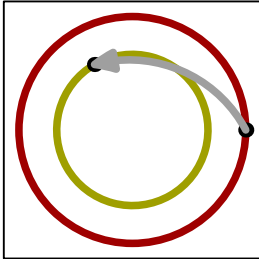

In the end we decide that although the trajectories look impressive, we will not trust our lives to METAPOST. A beautiful path is not necessarily a good path. But even then, this macro provides a nice way to experiment with directions, controls and tensions.

13.11 Selective randomization

In this document we have used a lot of randomization. Because CONTEXT often needs multiple runs to sort out cross references, positions, tables of contents, and so on, being real random every run would result in endless runs to get things right, because the size of graphics changes. This is prevented by storing the random seed between runs. You can remove the tuc file to get a new seed (or run `context --purgeall`).

Here is another example of randomization. This time we only randomize the control points so the main shape sort of remains intact which can be handy when you use such random shapes around text but still want a predictable size.

```
\startMPcode
fill fullcircle scaled 2cm
  randomizedcontrols 0.1cm
  withcolor darkred
  withtransparency (1,.5) ;
fill ((1cm,0)--(0,1cm)--(-1cm,0)--cycle)
  randomizedcontrols 0.1cm
  withcolor darkblue
  withtransparency (1,.5) ;
\stopMPcode
```

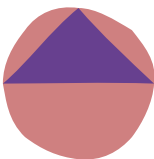

```
\startMPcode
draw image (
  fill fullcircle scaled 2cm
```



```

        withcolor darkred
        withtransparency (1,.5) ;
fill ((1cm,0)--(0,1cm)--(-1cm,0)--cycle)
        withcolor darkblue
        withtransparency (1,.5) ;
) randomizedcontrols 0.1cm ;
\stopMPcode

```

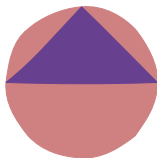

13.12 Snapping

There are quite some helpers in METAFUN and I must admit that I forgot about most. Some just ended up in the core because they can be useful, others serve as illustration. Here's one of them: snapped. First we define a few helpers that we then use to check out a few shapes.

```

\startMPdefinitions
def ShowSnapGrid(text shape) =
  fill (shape xsized 77mm) withcolor white/3 ;
  draw image (
    for i=10mm step 5mm until 100mm :
      draw fullsquare scaled i ;
    endfor ;
  ) withcolor 2white/3 ;
  drawpoints (shape xsized 77mm) withcolor black ;
enddef ;

vardef SnapShape expr shape =
  image (
    draw      shape ;
    drawpoints shape ;
  )
enddef ;

vardef ShowSnapShape expr shape =
  ShowSnapGrid(shape);

  draw SnapShape(shape xsized 77mm snapped -5mm      ) withcolor red ;
  draw SnapShape(shape xsized 77mm snapped  5mm      ) withcolor red ;
  draw SnapShape(shape xsized 77mm snapped (5mm,10mm)) withcolor green ;
  draw SnapShape(shape xsized 77mm snapped (5mm,15mm)) withcolor blue ;
  draw SnapShape(shape xsized 77mm snapped (5mm,20mm)) withcolor yellow ;
enddef ;
\stopMPdefinitions

```

In figures 13.7, 13.8 and 13.9 we see how the original shape gets snapped on the grid. Of course in more complex images the direction of the snapping can change the result in an unwanted way, like overlapping shapes that obscure others, but normally this snapping is only useful for simple predictable cases (like title pages).

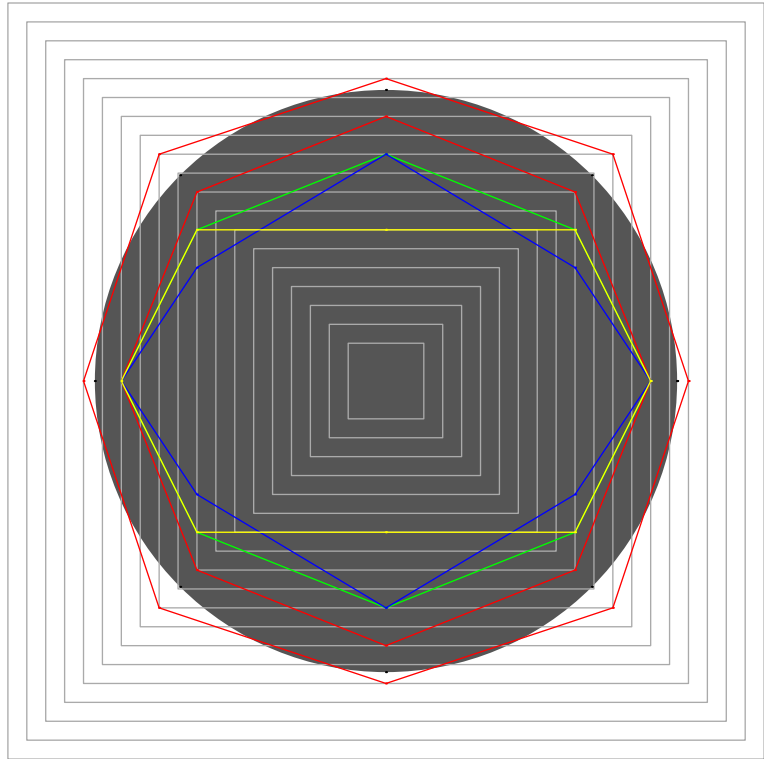

Figure 13.7 Messing with fullcircle.

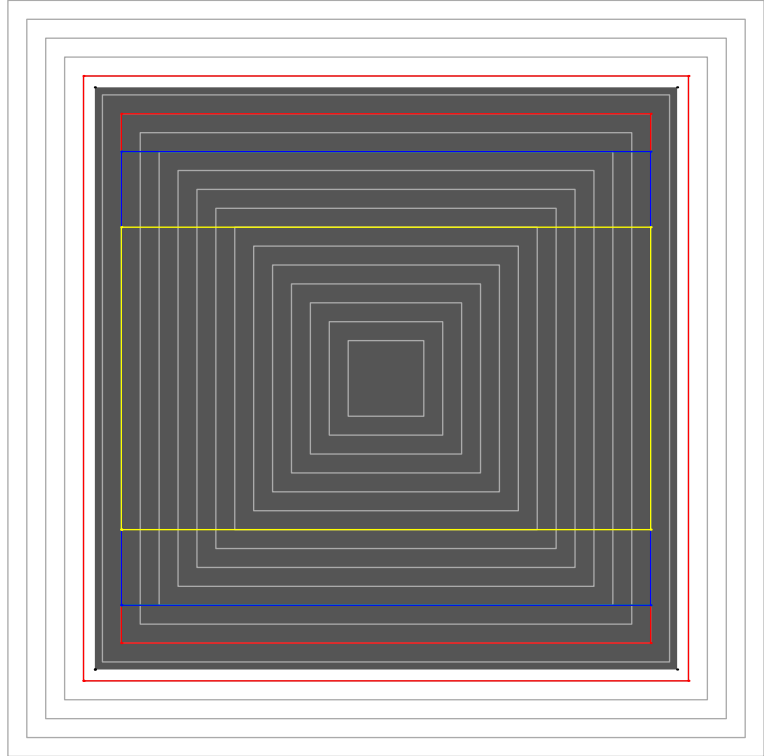

Figure 13.8 fullsquare

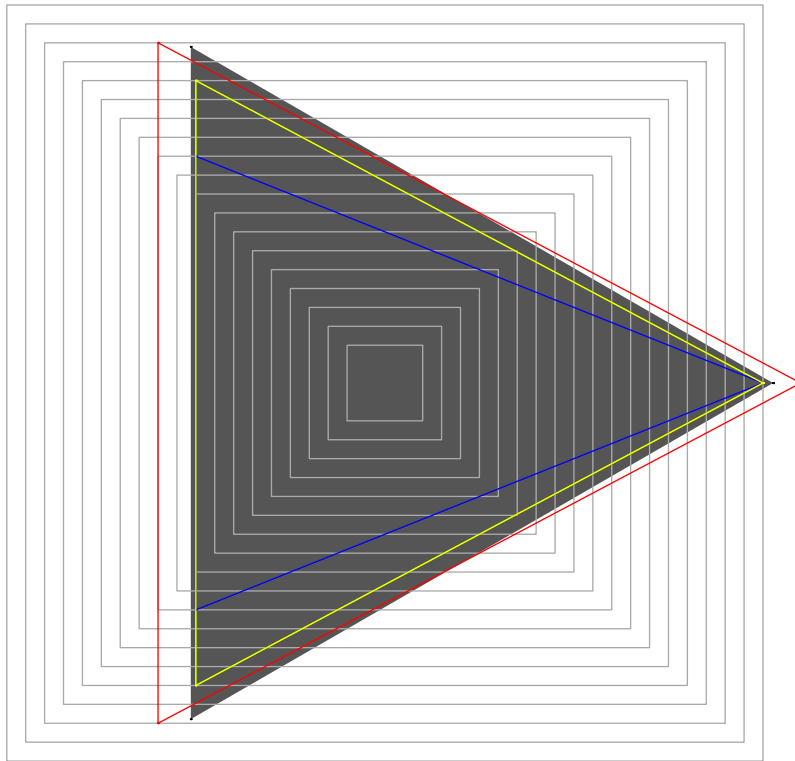

Figure 13.9 fulltriangle

13.13 Arrowheads

Arrows are actually drawn quite well in METAPOST, as the arrowheads nicely adapt to the direction of the point where the arrowhead is attached. There are however some limitations as the following examples demonstrate: arrows don't work well with transparency and you can probably figure out why. Alan Braslau came up with an extension that allows to set the dimple of the head. You can see all this in figure 13.10.

```

numeric unit ; unit := mm ;
drawoptions(withcolor .6blue withtransparency (1,.25)) ;
pickup pencircle scaled 2unit ; ahlength := 6unit ;
picture p ; p := image (
  drawarrow reverse fullcircle rotated - 5 scaled 50unit ;
  drawarrow reverse fullcircle rotated -10 scaled 30unit ;
) shifted ( -45unit, 0unit) ;
for i=0 step 90 until 360 : draw p rotated i ; endfor ;
currentpicture := currentpicture shifted - center currentpicture ;
p := currentpicture ; p := image (
  draw llcorner p -- center p ;
  drawarrow llcorner p -- 0.875[llcorner p,center p] ;
) ;
for i=0 step 90 until 360 : draw p rotated i ; endfor ;

```

```
clip currentpicture to boundingbox (fullcircle scaled 80unit) ;
if lua.mp.mode("screen") :
  currentpicture := currentpicture yscaled .4TextHeight ;
else :
  currentpicture := currentpicture xsized .4TextWidth ;
fi ;
```

13.14 Teaser

Sometimes, when playing with METAPOST you run into interesting cases. Here is one. The result is shown in figure 13.11.

```
\startusableMPgraphic{BackgroundTeaser}
  fill OverlayBox enlarged 1mm withcolor darkyellow ; % bleed
  path p ; p := OverlayBox enlarged -5mm ;
  path q ; q := OverlayBox enlarged -10mm ;
  fill q withcolor white ;
  drawoptions(withcolor darkred) ;
  fill reverse topboundary q -- topboundary p -- cycle ;
  fill reverse bottomboundary q -- bottomboundary p -- cycle ;
  drawoptions(withcolor darkgreen) ;
  fill reverse leftboundary q -- leftboundary p -- cycle ;
  fill reverse rightboundary q -- rightboundary p -- cycle ;
\stopusableMPgraphic

\defineoverlay
  [BackgroundTeaser]
  [\useMPgraphic{BackgroundTeaser}]

\framed
  [frame=off,
  offset=15mm,
  background=BackgroundTeaser,
  align=normal]
  {\input knuth }
```

13.15 Lists

For some specific purpose I needed to sort a list of paths and therefore METAFUN comes with a quick sort macro. Its working can be demonstrated by an example.

```
pair p[], pp[] ; numeric n ; n := 25 ;
for i=1 upto n : p[i] := origin randomized 4cm ; endfor ;

copylist(p,pp) ; % unsorted
drawarrow listtolines(pp) shifted ( 0,0) withcolor darkblue ;

copylist(p,pp) ; sortlist(pp)() ; % sorted
drawarrow listtolines(pp) shifted (300,0) withcolor darkyellow ;

copylist(p,pp) ; sortlist(pp)(xpart) ;
```

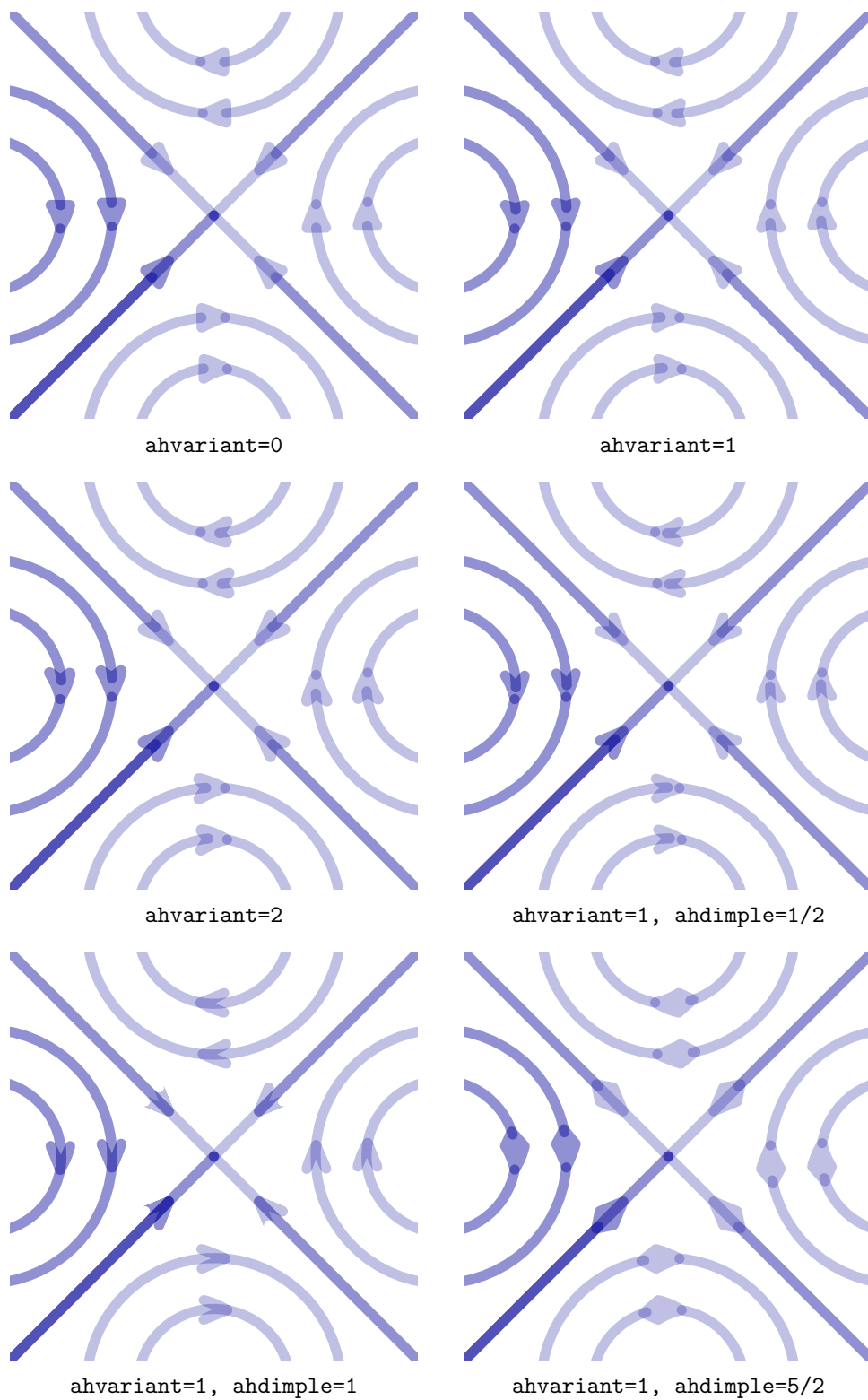

Figure 13.10 The way arrowheads are constructed.

```
drawarrow listtolines(pp) shifted (100,0) withcolor darkred ;
```

Thus, I came to the conclusion that the designer of a new system must not only be the implementer and first large-scale user; the designer should also write the first user manual.

The separation of any of these four components would have hurt \TeX significantly. If I had not participated fully in all these activities, literally hundreds of improvements would never have been made, because I would never have thought of them or perceived why they were important.

But a system cannot be successful if it is too strongly influenced by a single person. Once the initial design is complete and fairly robust, the real test begins as people with many different viewpoints undertake their own experiments.

Figure 13.11 Can you guess what happens here?

```

copylist(p,pp) ; sortlist(pp)(ypart) ;
drawarrow listtolines(pp) shifted (200,0) withcolor darkgreen ;

vardef whow expr p = (xpart p + ypart p) enddef ;

copylist(p,pp) ; sortlist(pp)(whow) ;
drawarrow listtolines(pp) shifted (400,0) withcolor darkcyan ;

vardef whow expr p = (xpart p ++ ypart p) enddef ;

copylist(p,pp) ; sortlist(pp)(whow) ;
drawarrow listtolines(pp) shifted (500,0) withcolor darkmagenta ;

```

The result of this code is shown in figure 13.12.

There is a helper that converts a list of paths into a shape that covers all of them. In figure 13.13 three shaped lists are shown.

```

def ShowShape(expr e) =
  draw image (
    save p ; path p[] ;
    def MakeShape(expr i,w,h,x,y) =
      p[i] := e
        xysized ((w,h) randomized (2mm,1mm))
        shifted ((x,y) randomized (2mm,1mm)) ;
    enddef ;
    MakeShape(1,40mm,6mm,10mm, 0mm) ;
    MakeShape(2,50mm,5mm, 5mm,-10mm) ;
    MakeShape(3,20mm,8mm,30mm,-20mm) ;
    MakeShape(4,55mm,5mm,10mm,-30mm) ;
    MakeShape(5,55mm,5mm, 5mm,-50mm) ;
  )

```

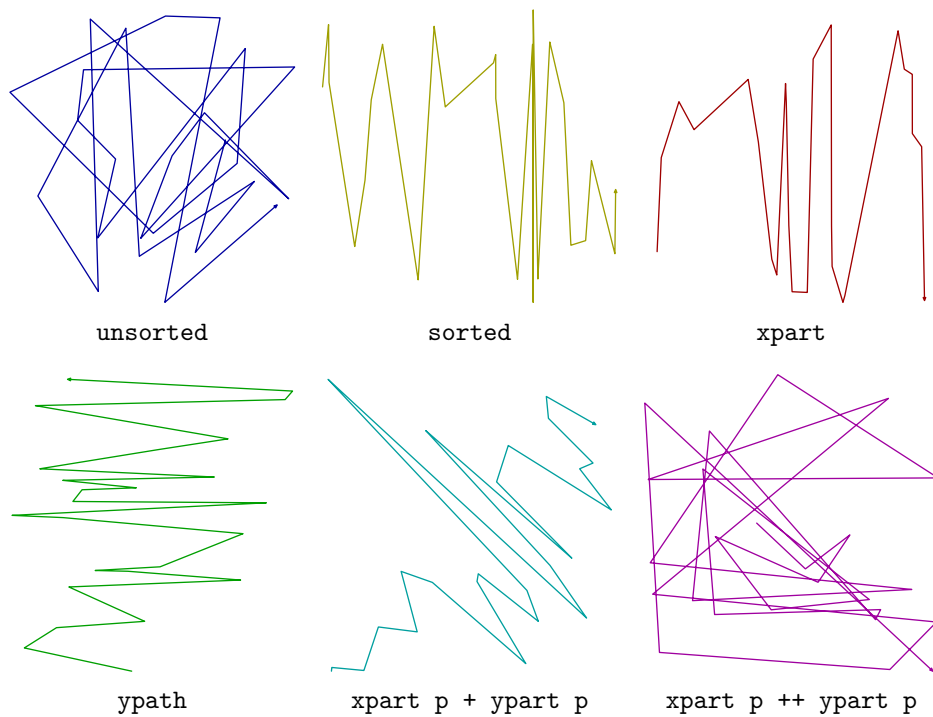

Figure 13.12 Using the sorter.

```

save s ; path s ; s := shapelist(p) ; drawarrow s ;
linejoin := butt ;
for i=1 upto 5 :
  fill p[i] withcolor .75white withtransparency (1,.5) ;
  draw thetext("\tttf " & decimal i, center p[i]) ;
endfor ;
) ysize 4cm ;
enddef ;

```

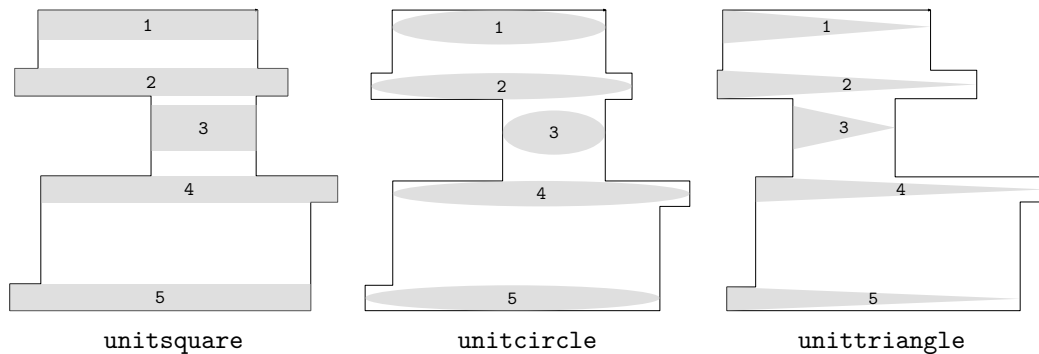

Figure 13.13 The shapelist macro returns the envelope that covers all the paths in the list.

13.16 Table cells

Sometimes a standard `CONTEXT` feature doesn't work out as expected. Take the following table:

```
\bTABLE[frame=on,framecolor=blue,rulethickness=1pt]
  \bTR
    \bTD test \eTD
    \bTD test \eTD
    \bTD test \eTD
    \bTD[framecolor=magenta] test \eTD
    \bTD test \eTD
    \bTD test \eTD
  \eTR
  \bTR
    \bTD test \eTD
    \bTD[framecolor=red] test \eTD
    \bTD test \eTD
    \bTD test \eTD
    \bTD test \eTD
    \bTD[framecolor=green] test \eTD
  \eTR
\eTABLE
```

Because cells are drawn top-down and left-right a next cell border overruns the previous one.

test	test	test	test	test	test
test	test	test	test	test	test

You can try this:

```
\bTABLE[frame=on,framecolor=blue,rulethickness=1pt]
  \bTR
    \bTD test \eTD
    \bTD test \eTD
    \bTD test \eTD
    \bTD[framecolor=magenta,frameoffset=-.5pt] test \eTD
    \bTD test \eTD
    \bTD test \eTD
  \eTR
  \bTR
    \bTD test \eTD
    \bTD[framecolor=red,frameoffset=-.5pt] test \eTD
    \bTD test \eTD
    \bTD test \eTD
    \bTD test \eTD
    \bTD[framecolor=green,frameoffset=-.5pt] test \eTD
  \eTR
\eTABLE
```

which gives us something that is not okay either for cells that touch an edge:

test	test	test	test	test	test
test	test	test	test	test	test

but we can cheat:

test	test	test	test	test	test
test	test	test	test	test	test

This is achieved by framing the whole table:

```
\framed
  [offset=overlay,
   frameoffset=.5pt,
   framecolor=blue,
   rulethickness=1pt]
  {...}
```

A METAPOST alternative is also possible and it gives a bit nicer interface too:

```
\startuseMPgraphic{cell:innerframe}{innercolor}
  draw OverlayBox enlarged -1.5OverlayLineWidth
    withpen pensquare scaled OverlayLineWidth
    withcolor \MPvar{innercolor} ;
\stopuseMPgraphic
\defineoverlay
  [innerframe]
  [{\uniqueMPgraphic{cell:innerframe}%
   {innercolor=\framedparameter{innercolor}}}]
\btTABLE[frame=on,framecolor=blue,rulethickness=1pt,innercolor=magenta]
  \bTR
    \bTD test \eTD
    \bTD test \eTD
    \bTD test \eTD
    \bTD[background=innerframe] test \eTD
    \bTD test \eTD
    \bTD test \eTD
  \eTR
  \bTR
    \bTD test \eTD
    \bTD[background=innerframe,innercolor=red] test \eTD
    \bTD test \eTD
    \bTD test \eTD
    \bTD test \eTD
    \bTD[background=innerframe,innercolor=green] test \eTD
  \eTR
\etTABLE
```

We get:

test	test	test	test	test	test
test	test	test	test	test	test

14 METAFUN macros

CONTEX_T comes with a series of METAPOST modules. In this chapter we will summarize the most important TEX and METAPOST macros. More information can be found in the documentation of the modules.

There are several ways to use the power of METAFUN, either or not using CONTEX_T.

1. You can create an independent mp file and process it with the METAPOST program or MPTOPDF. Depending on what features you use, the success of a run depends on the proper set up of the programs that take care of running TEX for b_tex.
2. You can embed the graphic in a `\startMPpage` construct and process it with CONTEX_T MKIV. In that case you have the full METAFUN functionality available. If for some reason you still want to use MKII, you need to use TEXEXEC as before processing the file, it will do a couple of checks on the file. It will also make sure that the temporary files (mpt for text_tex's and mpo for outline fonts) are taken care of too.
3. You can integrate the graphic in the document flow, using buffers, METAPOST code sections, or (reusable) graphic containers. In that case the graphics are processed runtime or between runs. This happens automatically.

Unless you want to write low level CONTEX_T code yourself, there is no real reason to look into the modules that deal with METAPOST support. The traditional (partly generic) code is collected in:

```

supp-mps.tex  low level inclusion macros and housekeeping
supp-mpe.tex  experimental extensions (like specials)
supp-pdf.tex  METAPOST to PDF conversion

```

Especially the last two can be used in other macro packages. However, in CONTEX_T we have regrouped the code (plus more) in other files:

```

meta-***.tex  definition and managing
mlib-***.tex  processing and conversion

```

The last category will certainly grow. Some of these modules are preloaded, others can be loaded using the command `\useMPLibrary`, like

```
\useMPLibrary[clp,txt]
```

for loading the predefined clipping paths and text tricks.

The METAPOST code is organized in files named `mp-****.mp`. The core file is `mp-tool.mp` and this file can comfortably be used in stand-alone graphics. The file `metafun.mp` is used to load the collection of modules into a format. The collection of METAPOST code files will grow in due time, but as long as you use the METAFUN format, you don't have to keep track of the organization of files. Most files relate to subsystems and are loaded automatically, like the files that implement page layout support and flow charts.

Although this document is the main source of information, occasionally the source code of METAFUN, and in many cases the source code of CONTEX_T may contain additional information and examples.

15 Lua

Already for some years I have been wondering how it would be if we could escape to LUA inside METAPOST, or in practice, use MPLIB in L^AT_EX. The idea is simple: embed LUA code in a METAPOST file that gets run as soon as it's seen. In case you wonder why LUA code makes sense, imagine generating graphics using external data. The capabilities of LUA to deal with that is more flexible and advanced than in METAPOST. Of course we could generate a METAPOST definition of a graphic from data but often it makes more sense to do the reverse. I finally found time and reason to look into this and in the following sections I will describe how it's done.

15.1 Introduction

15.2 The basics

The approach is comparable to L^AT_EX's `\directlua`. That primitive can be used to execute LUA code and in combination with `tex.print` we can pipe back strings into the T_EX input stream. There a complication is that that we have to be able to operate under different so called catcode regimes: the meaning of characters can differ per regime. We also have to deal with line endings in special ways as they relate to paragraphs and such. In METAPOST we don't have that complication so getting back input into the METAPOST input, we can do so with simple strings. For that a mechanism similar to `scantokens` can be used. That way we can return anything (including nothing) as long as METAPOST can interpret it and as long as it fulfils the expectations.

```
numeric n ; n := scantokens("123.456") ;
```

A script is run as follows:

```
numeric n ; n := runscript("return '123.456'") ;
```

This primitive doesn't have the word `lua` in its name so in principle any wrapper around the library can use it as hook. In the case of L^AT_EX the script language is of course LUA. At the METAPOST end we only expect a string. How that string is constructed is completely up to the LUA script. In fact, the user is completely free to implement the runner any way she or he wants, like:

```
local function scriptrunner(code)
  local f = loadstring(code)
  if f then
    return tostring(f())
  else
    return ""
  end
end
```

This is hooked into an instance as follows:

```
local m = mplib.new {
  ...
  run_script = scriptrunner,
  ...
}
```

```
}

```

Now, beware, this is not the `CONTEXT` way. We provide print functions and other helpers, which we will explain in the next section.

15.3 Helpers

After I got this feature up and running I played a bit with possible interfaces at the `CONTEXT` (read: `METAFUN`) end and ended up with a bit more advanced runner where no return value is used. The runner is wrapped in the `lua` macro.

```
numeric n ; n := lua("mp.print(12.34567)") ;
draw texttext(n) xscaled 4cm withcolor darkred ;
```

This renders as:

12.34567

In case you wonder how efficient calling `LUA` is, don't worry: it's fast enough, especially if you consider suboptimal `LUA` code and the fact that we switch between machineries.

```
draw image (
  lua("statistics.starttiming()") ;
  for i=1 upto 10000 : draw
    lua("mp.pair(math.random(-200,200),math.random(-50,50))") ;
  endfor ;
  setbounds currentpicture to fullsquare xyscaled (400,100) ;
  lua("statistics.stoptiming()") ;
) withcolor darkyellow withpen pencircle scaled 1 ;
draw texttext(lua("mp.print(statistics.elapsedtime())"))
  yscaled 50 withcolor darkred ;
```

Here the line:

```
draw lua("mp.pair(math.random(-200,200),math.random(-50,50))") ;
```

effectively becomes (for instance):

```
draw scantokens "(25,40)" ;
```

which in turn becomes:

```
draw scantokens (25,40) ;
```

The same happens with this:

```
draw texttext(lua("mp.print(statistics.elapsedtime())")) ...
```

This becomes for instance:

```
draw texttext(scantokens "1.23") ...
```

and therefore:

```
draw texttext(1.23) ...
```

We can use `mp.print` here because the `texttext` macro can deal with numbers. The next also works:

```
draw texttext(lua("mp.quoted(statistics.elapsedtime())")) ...
```

Now we get (in METAPost speak):

```
draw texttext(scantokens (ditto & "1.23" & ditto)) ...
```

Here `ditto` represents the double quotes that mark a string. Of course, because we pass the strings directly to `scantokens`, there are no outer quotes at all, but this is how it can be simulated. In the end we have:

```
draw texttext("1.23") ...
```

What you use, `mp.print` or `mp.quoted` depends on what the expected code is: an assignment to a numeric can best be a number or an expression resulting in a number.

This graphic becomes:



The runtime on my current machine is some 0.25 seconds without and 0.12 seconds with caching. But to be honest, speed is not really a concern here as the amount of complex METAPost graphics can be neglected compared to extensive node list manipulation. With L^UAJIT_{TE}X generating the graphic takes 15% less time.

The three print command accumulate their arguments:

```
numeric n ; n := lua("mp.print(1) mp.print('+') mp.print(2)") ;
draw texttext(n) xsize 1cm withcolor darkred ;
```

As expected we get:

Equally valid is:

```
numeric n ; n := lua("mp.print(1, '+', 2)") ;
draw texttext(n) xsize 1cm withcolor darkred ;
```

This gives the same result:

3

Of course all kind of action can happen between the prints. It is also legal to have nothing returned as could be seen in the 10.000 dot example: there the timer related code returns nothing so effectively we have `scantokens("")`. Another helper is `mp.quoted`, as in:

```
draw
  texttext(lua("mp.quoted('@0.3f'," & decimal n & ")))
  withcolor darkred ;
```

This typesets **3.000**. Watch the @. When no percent character is found in the format specifier, we assume that an @ is used instead.

But, the real benefit of embedded LUA is when we deal with data that is stored at the LUA end. First we define a small dataset:

```
\startluacode
table.save("demo-data.lua",
  {
    { 1, 2 }, { 2, 4 }, { 3, 3 }, { 4, 2 },
    { 5, 2 }, { 6, 3 }, { 7, 4 }, { 8, 1 },
  }
)
\stopluacode
```

There are several ways to deal with this table. I will show clumsy as well as better looking ways.

```
lua("MP = { } MP.data = table.load('demo-data.lua')") ;
numeric n ;
lua("mp.print('n := ',\#MP.data)") ;
for i=1 upto n :
  drawdot
    lua("mp.pair(MP.data[" & decimal i & "])") scaled cm
    withpen pencircle scaled 2mm
    withcolor darkred ;
endfor ;
```

Here we load a LUA table and assign the size to a METAPOST numeric. Next we loop over the table entries and draw the coordinates.

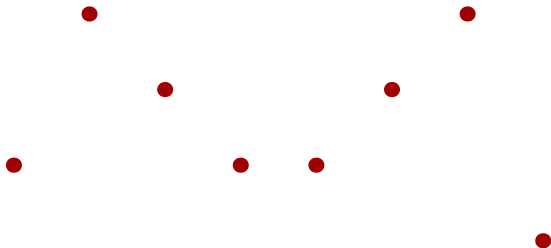

We will stepwise improve this code. In the previous examples we omitted wrapper code but here we show it:



```

\startluacode
  MP.data = table.load('demo-data.lua')
  function MP.n()
    mp.print(#MP.data)
  end
  function MP.dot(i)
    mp.pair(MP.data[i])
  end
\stopluacode

\startMPcode
  numeric n ; n := lua("MP.n()") ;
  for i=1 upto n :
    drawdot
      lua("MP.dot(" & decimal i & ")") scaled cm
      withpen pencircle scaled 2mm
      withcolor darkred ;
  endfor ;
\stopMPcode

```

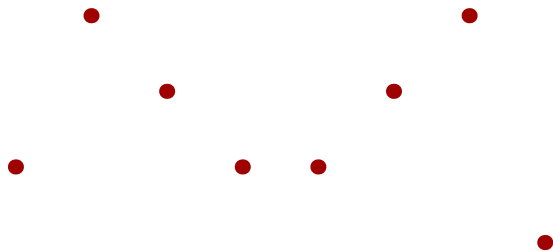
So, we create a few helpers in the MP table. This table is predefined so normally you don't need to define it. You may however decide to wipe it clean.



You can decide to hide the data:

```

\startluacode
  local data = { }
  function MP.load(name)
    data = table.load(name)
  end
  function MP.n()
    mp.print(#data)
  end
  function MP.dot(i)
    mp.pair(data[i])
  end
\stopluacode

```

It is possible to use less LUA, for instance in:

```

\startluacode
  local data = { }
  function MP.loaded(name)
    data = table.load(name)
  end
\stopluacode

```

```

        mp.print(#data)
    end
    function MP.dot(i)
        mp.pair(data[i])
    end
\stopluacode
\startMPcode
    for i=1 upto lua("MP.loaded('demo-data.lua')") :
        drawdot
            lua("MP.dot(",i,"") scaled cm
            withpen pencircle scaled 4mm
            withcolor darkred ;
    endfor ;
\stopMPcode

```

Here we also omit the decimal because the lua macro is clever enough to recognize it as a number.

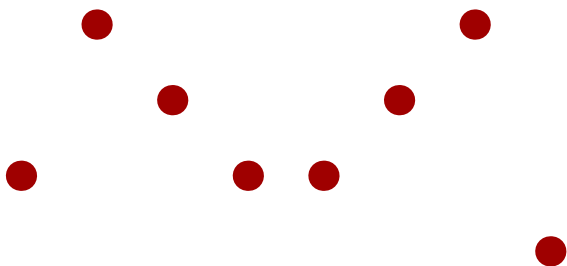

By using some METAPOST magic we can even go a step further in readability:

```

\startMPcode{doublefun}
    lua.MP.load("demo-data.lua") ;

    for i=1 upto lua.MP.n() :
        drawdot
            lua.MP.dot(i) scaled cm
            withpen pencircle scaled 4mm
            withcolor darkred ;
    endfor ;

    for i=1 upto MP.n() :
        drawdot
            MP.dot(i) scaled cm
            withpen pencircle scaled 2mm
            withcolor white ;
    endfor ;
\stopMPcode

```

Here we demonstrate that it also works ok in double mode, which makes much sense when processing data from other sources. Watch how we omit the type lua. prefix: the MP macro will deal with that.

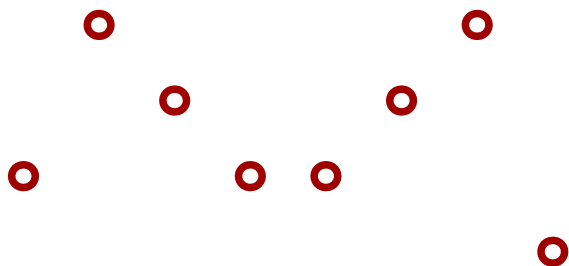

So in the end we can simplify the code that we started with to:

```
\startMPcode{doublefun}
  for i=1 upto MP.loaded("demo-data.lua") :
    drawdot
      MP.dot(i) scaled cm
      withpen pencircle scaled 2mm
      withcolor darkred ;
  endfor ;
\stopMPcode
```

15.4 Access to variables

The question with such mechanisms is always: how far should we go. Although METAPOST is a macro language it has properties of procedural languages. It also has more introspective features at the user end. For instance, one can loop over the resulting picture and manipulate it. This means that we don't need full access to METAPOST internals. However, it makes sense to provide access to basic variables: numeric, string, and boolean.

```
draw texttext(lua("mp.quoted('@0.15f',mp.get.numeric('pi')-math.pi")))
  ysize 1cm
  withcolor darkred ;
```

In double mode you will get zero printed but in scaled mode we definitely get a difference:

-0.000006349878856

In the next example we use `mp.quoted` to make sure that indeed we pass a string. The `texttext` macro can deal with numbers but an unquoted yes or no is asking for problems.

```
boolean b ; b := true ;
draw texttext(lua("mp.quoted(mp.get.boolean('b') and 'yes' or 'no')"))
  ysize 1cm
  withcolor darkred ;
```

Especially when more text is involved it makes sense to predefine a helper in the MP namespace if only because METAPOST (currently) doesn't like newlines in the middle of a string, so a lua call has to be on one line.

no

Here is an example where LUA does something that would be close to impossible, especially if more complex text is involved.

```
string s ; s := "TEX" ; % ""
draw texttext(lua("mp.quoted(characters.lower(mp.get.string('s'))"))
  ysize 1cm
  withcolor darkred ;
```

As you can see here, the whole repertoire of helper functions can be used in a METAFUN definition.

TEX

15.5 The library

In CONTEXT we have a dedicated runner, but for the record we mention the low level constructor:

```
local m = mplib.new {
  ...
  script_runner = function(s) return loadstring(s)() end,
  script_error = function(s) print(s) end,
  ...,
}
```

An instance (in this case `m`) has a few extra methods. Instead you can use the helpers in the library.

<code>m:get_numeric(name)</code>	returns a numeric (double)
<code>m:get_boolean(name)</code>	returns a boolean (true or false)
<code>m:get_string (name)</code>	returns a string

<code>mplib.get_numeric(m,name)</code>	returns a numeric (double)
<code>mplib.get_boolean(m,name)</code>	returns a boolean (true or false)
<code>mplib.get_string (m,name)</code>	returns a string

In CONTEXT the instances are hidden and wrapped in high level macros, so there you cannot use these commands.

15.6 CONTEXT helpers

The `mp` namespace provides the following helpers:

<code>print(...)</code>	returns one or more values
<code>pair(x,y) pair(t)</code>	returns a proper pair
<code>triplet(x,y,z) triplet(t)</code>	returns an RGB color
<code>quadruple(w,x,y,z) quadruple(t)</code>	returns an CMYK color
<code>format(fmt,...)</code>	returns a formatted string
<code>quoted(fmt,...) quoted(s)</code>	returns a (formatted) quoted string
<code>path(t[,connect][,close])</code>	returns a connected (closed) path

The `mp.get` namespace provides the following helpers:

<code>numeric(name)</code>	gets a numeric from METAPOST
<code>boolean(name)</code>	gets a boolean from METAPOST
<code>string(name)</code>	gets a string from METAPOST

15.7 Paths

In the meantime we got several questions on the `CONTEXT` mailing list about turning coordinates into paths. Now imagine that we have this dataset:

```

10 20 20 20 -- sample 1
30 40 40 60
50 10

10 10 20 30 % sample 2
30 50 40 50
50 20

10 20 20 10 # sample 3
30 40 40 20
50 10

```

In this case I've put the data in a buffer so that it can be shown here as well as used in a demo. Watch how we can add comments. The following code converts this into a table with three subtables.

```

\startluacode
  MP.myset = mp.dataset(buffers.getcontent("dataset"))
\stopluacode

```

We use the `MP` (user) namespace to store the table. Next we turn these subtables into paths:

```

\startMPcode
  for i=1 upto lua("mp.print(mp.n(MP.myset))") :
    draw
      lua("mp.path(MP.myset[" & decimal i & "])")
      xysized (HSize-.25ExHeight,10ExHeight)
      withpen pencircle scaled .25ExHeight
      withcolor basiccolors[i]/2 ;
    endfor ;
\stopMPcode

```

This gives:

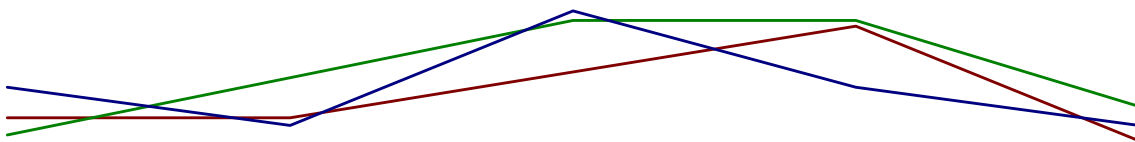

Instead we can fill the path in which case we also need to close it. The `true` argument deals with that:

```

\startMPcode
  for i=1 upto lua("mp.print(mp.n(MP.myset))") :

```

```

path p ; p :=
  lua("mp.path(MP.myset[" & decimal i & "],true)")
  xysized (HSize,10ExHeight) ;
fill p
  withcolor basiccolors[i]/2
  withtransparency (1,.5) ;
endfor ;
\stopMPcode

```

We get:

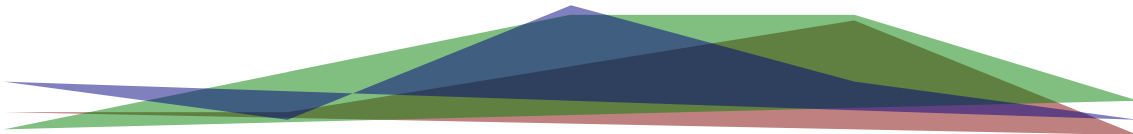

The following makes more sense:

```

\startMPcode
for i=1 upto lua("mp.print(mp.n(MP.myset))") :
  path p ; p :=
    lua("mp.path(MP.myset[" & decimal i & "])")
    xysized (HSize,10ExHeight) ;
  p :=
    (xpart llcorner boundingbox p,0) --
    p --
    (xpart lrcorner boundingbox p,0) --
    cycle ;
  fill p
    withcolor basiccolors[i]/2
    withtransparency (1,.25) ;
endfor ;
\stopMPcode

```

So this gives:

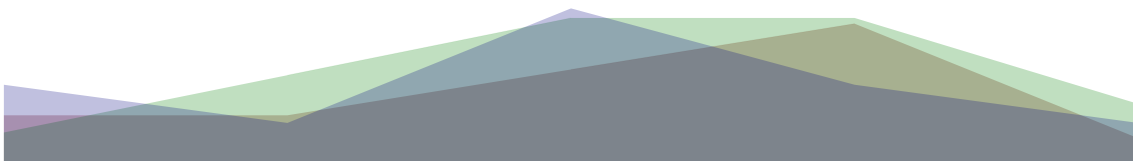

This (area) fill is so common that we have a helper for it:

```

\startMPcode
for i=1 upto lua("mp.size(MP.myset)") :
  fill area
    lua("mp.path(MP.myset[" & decimal i & "])")
    xysized (HSize,5ExHeight)
    withcolor basiccolors[i]/2
    withtransparency (2,.25) ;
endfor ;

```

```
\stopMPcode
```

So this gives:



A variant call is the following:¹⁷

```
\startMPcode
  for i=1 upto lua("mp.size(MP.myset)") :
    fill area
      lua("mp.path(MP.myset[mp.get.numeric('i')])")
      xysized (HSize,5ExHeight)
      withcolor basiccolors[i]/2
      withtransparency (2,.25) ;
    endfor ;
\stopMPcode
```

The result is the same:



```
\startluacode
  MP.mypath = function(i)
    return mp.path(MP.myset[mp.get.numeric(i)])
  end
\stoptluacode

\startMPcode
  for i=1 upto lua("mp.size(MP.myset)") :
    fill area
      lua("MP.mypath('i')")
      xysized (HSize,5ExHeight)
      withcolor basiccolors[i]/2
      withtransparency (2,.25) ;
    endfor ;
\stopMPcode
```

This snippet of METAPOST code still looks kind of horrible so how can we make it look better? Here is an attempt, First we define a bit more LUA:

```
\startluacode
  local data = mp.dataset(buffers.getcontent("dataset"))

  MP.dataset = {
    Line = function(n) mp.path(data[n]) end,
    Size = function() mp.size(data) end,
  }
\stoptluacode
```

¹⁷ Getting that to work properly in the library was non-trivial as the loop variable `i` is an abstract nameless variable at the METAPOST end. When investigating this Luigi Scarso and I found out that the internals of METAPOST are not really geared for interfacing this way but in the end it worked out well.

```

}
\stopluacode

```

We can now make the METAPOST look more natural. Of course this is possible because in METAFUN the lua macro does some extra work.

```

\startMPcode
  for i=1 upto lua.MP.dataset.Size() :
    path p ; p :=
      lua.MP.dataset.Line(i)
      xysized (HSize-ExHeight,20ExHeight) ;
    draw
      p
      withpen pencircle scaled .25ExHeight
      withcolor basiccolors[i]/2 ;
    drawpoints
      p
      withpen pencircle scaled ExHeight
      withcolor basiccolors[i]/2 ;
  endfor ;
\stopMPcode

```

As expected, we get the desired result:

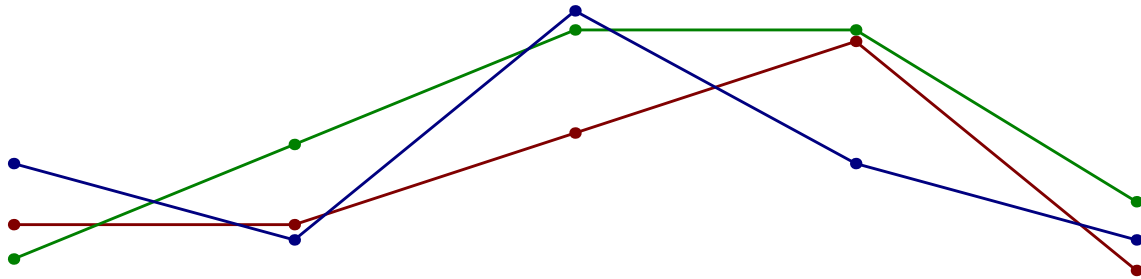

Once we start making things look nicer and more convenient, we quickly end up with helpers like the once in the next example. First we save some demo data in files:

```

\startluacode
  io.savedata("foo.tmp","10 20 20 20 30 40 40 60 50 10")
  io.savedata("bar.tmp","10 10 20 30 30 50 40 50 50 20")
\stopluacode

```

We load the data in datasets:

```

\startMPcode
  lua.mp.datasets.load("foo","foo.tmp") ;
  lua.mp.datasets.load("bar","bar.tmp") ;
  fill area
    lua.mp.datasets.foo.Line()
    xysized (HSize/2-EmWidth-.25ExHeight,10ExHeight)
    withpen pencircle scaled .25ExHeight
    withcolor darkyellow ;
  fill area

```



```

lua.mp.datasets.bar.Line()
xysized (HSize/2-EmWidth-.25ExHeight,10ExHeight)
shifted (HSize/2+EmWidth,0)
withpen pencircle scaled .25ExHeight
withcolor darkred ;
\stopMPcode

```

Because the datasets are stores by name we can use them without worrying about them being forgotten:

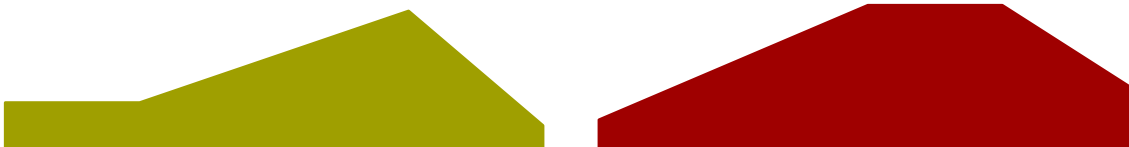

If no tag is given, the filename (without suffix) is used as tag, so the following is valid:

```

\startMPcode
lua.mp.datasets.load("foo.tmp") ;
lua.mp.datasets.load("bar.tmp") ;
\stopMPcode

```

The following methods are defined for a dataset:

method	usage
Size	the number of subsets in a dataset
Line	the joined pairs in a dataset making a non-closed path
Data	the table containing the data (in subsets, so there is always at least one subset)

In order avoid interference with suffix handling in METAPOST the methods start with an uppercase character.

15.8 Passing variables

You can pass variables from METAPOST to CONTEXT. Originally that happened via a temporary file and so called METAPOST specials. Nowadays it's done via LUA. Here is an example:

```

\startMPcalculation

passvariable("version","1.0") ;
passvariable("number",123) ;
passvariable("string","whatever") ;
passvariable("point",(1.5,2.8)) ;
passvariable("triplet",(1/1,1/2,1/3)) ;
passvariable("quad",(1.1,2.2,3.3,4.4)) ;
passvariable("boolean",false) ;
passvariable("path",fullcircle scaled 1cm) ;
path p[] ; p[1] := fullcircle ; p[2] := fullsquare ;
passarrayvariable("list",p,1,2,1) ; % first last step
\stopMPcalculation

```

We can visualize the result with

```

\startluacode
context.tocontext(metapost.variables)
\stoptluacode

t={
  ["boolean"]=false,
  ["list"]={
    {
      { 0.5, 0, 0.5, -0.13261, 0.5, 0.13261 },
      { 0.35355, 0.35355, 0.44731, 0.25978, 0.25978, 0.44731 },
      { 0, 0.5, 0.13261, 0.5, -0.13261, 0.5 },
      { -0.35355, 0.35355, -0.25978, 0.44731, -0.44731, 0.25978 },
      { -0.5, 0, -0.5, 0.13261, -0.5, -0.13261 },
      { -0.35355, -0.35355, -0.44731, -0.25978, -0.25978, -0.44731 },
      { 0, -0.5, -0.13261, -0.5, 0.13261, -0.5 },
      { 0.35355, -0.35355, 0.25978, -0.44731, 0.44731, -0.25978 },
      { 0.5, 0, 0.5, -0.13261, 0.5, 0.13261 },
    },
    {
      { -0.5, -0.5, -0.5, -0.16667, -0.16667, -0.5 },
      { 0.5, -0.5, 0.16667, -0.5, 0.5, -0.16667 },
      { 0.5, 0.5, 0.5, 0.16667, 0.16667, 0.5 },
      { -0.5, 0.5, -0.16667, 0.5, -0.5, 0.16667 },
      { -0.5, -0.5, -0.5, -0.16667, -0.16667, -0.5 },
    },
  },
  ["number"]=123,
  ["path"]={
    { 14.17323, 0, 14.17323, -3.75914, 14.17323, 3.75914 },
    { 10.02177, 10.02177, 12.67969, 7.36386, 7.36386, 12.67969 },
    { 0, 14.17323, 3.75914, 14.17323, -3.75914, 14.17323 },
    { -10.02177, 10.02177, -7.36386, 12.67969, -12.67969, 7.36386 },
    { -14.17323, 0, -14.17323, 3.75914, -14.17323, -3.75914 },
    { -10.02177, -10.02177, -12.67969, -7.36386, -7.36386, -12.67969 },
    { 0, -14.17323, -3.75914, -14.17323, 3.75914, -14.17323 },
    { 10.02177, -10.02177, 7.36386, -12.67969, 12.67969, -7.36386 },
    { 14.17323, 0, 14.17323, -3.75914, 14.17323, 3.75914 },
  },
  ["point"]={ 1.5, 2.8 },
  ["quad"]={ 1.1, 2.2, 3.3, 4.4 },
  ["string"]="whatever",
  ["triplet"]={ 1, 0.5, 0.33333 },
  ["version"]="1.0",
}

```

In T_EX you can access these variables as follows:

```

\MPrunvar{version}
\MPruntab{quad}{3}
(\MPrunset{triplet}{,})

```

```
$(x,y) = (\MPpruntab{point}{1},\MPpruntab{point}{2})$
$(x,y) = (\MPprunset{point}{,})$
```

This becomes:

```
1.0
3.3
(1,0.5,0.33333)
```

```
(x,y) = (1.5,2.8)
(x,y) = (1.5,2.8)
```

Here we passed the code between `\startMPcalculation` and `\stopMPcalculation` which does not produce a graphic and therefore takes no space in the flow. Of course it also works with normal graphics.

```
\startMPcode
path p ; p := fullcircle xyscaled (10cm,2cm) ;
path b ; b := boundingbox p ;
startpassingvariable("mypath")
  passvariable("points",p) ;
  startpassingvariable("metadata")
    passvariable("boundingbox",boundingbox p) ;
  stoppassingvariable ;
stoppassingvariable ;
fill p withcolor .625red ;
draw b withcolor .625yellow ;
\stopMPcode
```



This time we get:

```
t={
  ["mypath"]={
    ["metadata"]={
      ["boundingbox"]={
        { -141.73225, -28.34645, -141.73225, -9.44882, -47.24408, -28.34645 },
        { 141.73225, -28.34645, 47.24408, -28.34645, 141.73225, -9.44882 },
        { 141.73225, 28.34645, 141.73225, 9.44882, 47.24408, 28.34645 },
        { -141.73225, 28.34645, -47.24408, 28.34645, -141.73225, 9.44882 },
        { -141.73225, -28.34645, -141.73225, -9.44882, -47.24408, -28.34645 },
      },
    },
  },
  ["points"]={
    { 141.73225, 0, 141.73225, -7.51828, 141.73225, 7.51828 },
    { 100.21779, 20.04356, 126.7969, 14.72774, 73.63866, 25.35938 },
    { 0, 28.34645, 37.5914, 28.34645, -37.5914, 28.34645 },
  },
}
```

```

{ -100.21779, 20.04356, -73.63866, 25.35938, -126.7969, 14.72774 },
{ -141.73225, 0, -141.73225, 7.51828, -141.73225, -7.51828 },
{ -100.21779, -20.04356, -126.7969, -14.72774, -73.63866, -25.35938 },
{ 0, -28.34645, -37.5914, -28.34645, 37.5914, -28.34645 },
{ 100.21779, -20.04356, 73.63866, -25.35938, 126.7969, -14.72774 },
{ 141.73225, 0, 141.73225, -7.51828, 141.73225, 7.51828 },
},
},
}

```

You need to be aware of the fact that a next graphic resets the previous variables. You can easily overcome that limitation by saving the variables (in LUA). It helps that when a page is being shipped out (which can involve graphics) the variables are protected. You can push and pop variable sets with `\MPpushvariables` and `\MPpopvariables`. Because you can nest the start–stop pairs you can create quite complex indexed and hashed tables. If the results are not what you expect, you can enable a tracker to follow what gets passed:

```
\enabletrackers[metapost.variables]
```

Serializing variables can be done with the `tostring` macro, for instance:

In this case the `tostring` is redundant as the message already does the serialization.

16 Conventions

16.1 Suffixes

One characteristic of using METAFUN in `CONTEXT` is that it is basically one long run. The code snippets become figures that then get converted to PDF and embedded. If text is involved, each figure is actually processed twice, once to identify what needs to be typeset, and once with the result(ing metrics). Normally that gets unnoticed. You can check for the state by consulting the boolean `mfun_trial_run`.

A consequence of the one run cq. multiple runs is that you need to be careful with undefined or special variables. Consider the following:

```
vardef foo@#(text t) =
  save s ; string s ; s := str @# ;
  if length(s) > 0 :
    texttext(s)
  else :
    nullpicture
  fi
enddef ;
```

The following works ok in the first run when `bar` is undefined:

```
draw foo.bar("a") ;
```

But if afterwards we say:

```
vardef bar(expr x) =
  123
enddef ;
```

and expand `foo.bar` again we will get an error message because this time `bar` expands. Suffixes are always expanded!

The lesson is: when you get unexpected results or errors, check your variable definitions. You can use the `begingroup` and `endgroup` primitives to protect your variables but then you also need to explicitly use `save` to store their meanings and allocate new ones after that inside the group.

A METAPOST syntax

In the *METAFONT* book as well as the *METAPOST* manual, you can find the exact specification of the language. Below you find the full *METAPOST* syntax, to which we add the basic *METAFUN* extensions. If this page looks too cryptic, you can safely skip to the next chapter. We don't distinguish between primitives and functionality defined in the *METAPOST* format, simply because the core is kept small and a macro package is supposed to extend that core.

The following syntax diagrams are derived from the diagrams in the *METAPOST* manual. The \rightarrow represents 'means' and the $|$ symbol stands for 'or'.

The diagrams describe the hard coded *METAPOST* syntax as well as most of the macros and variables defined in the plain *METAPOST* format that belongs to the core of the system. They also include most of the fundamental *METAFUN* commands. We have omitted the *METAPOST* and *METAFONT* commands that make no sense any more or are irrelevant for common usage. Specific *METAFUN* modules are not included here, only general tools, text helpers and extensions to the built-in capabilities like transparency. If you feel that something is missing that should be specified here, just let me know.

\langle atom \rangle

\rightarrow \langle variable \rangle \langle argument \rangle
 $|$ \langle number or fraction \rangle
 $|$ \langle internal variable \rangle
 $|$ \langle (expression) \rangle
 $|$ `begingroup` \langle statement list \rangle \langle expression \rangle `endgroup`
 $|$ \langle nullary op \rangle
 $|$ `btex` \langle typesetting command \rangle `etex`
 $|$ \langle pseudo function \rangle

\langle primary \rangle

\rightarrow \langle atom \rangle
 $|$ \langle (numeric expression) , \langle numeric expression \rangle \rangle
 $|$ \langle (numeric expression) , \langle numeric expression \rangle , \langle numeric expression \rangle \rangle
 $|$ \langle (numeric expression) , \langle numeric expression \rangle , \langle numeric expression \rangle , \langle numeric expression \rangle \rangle
 $|$ \langle of operator \rangle \langle expression \rangle `of` \langle primary \rangle
 $|$ \langle numeric expression \rangle \langle expression \rangle `along` \langle path expression \rangle
 $|$ \langle numeric expression \rangle \langle expression \rangle `on` \langle path expression \rangle
 $|$ \langle unary op \rangle \langle primary \rangle
 $|$ `str` \langle suffix \rangle
 $|$ `z` \langle suffix \rangle
 $|$ \langle numeric atom \rangle [\langle expression \rangle , \langle expression \rangle]
 $|$ \langle scalar multiplication op \rangle \langle primary \rangle
 $|$ \langle color expression \rangle `shadedinto` \langle color expression \rangle
 $|$ \langle picture expression \rangle `asgroup` \langle string expression \rangle
 $|$ \langle picture expression \rangle `onlayer` \langle string expression \rangle

\langle secondary \rangle

\rightarrow \langle primary \rangle
 $|$ \langle secondary \rangle \langle primary binop \rangle \langle primary \rangle
 $|$ \langle secondary \rangle \langle transformer \rangle

\langle tertiary \rangle

→ <secondary>
 | <tertiary> <secondary binop> <secondary>

<subexpression>
 → <tertiary>
 | <path expression> <path join> <path knot>

<expression>
 → <subexpression>
 | <expression> <tertiary binop> <tertiary>
 | <path subexpression> <direction specifier>
 | <path subexpression> <path join> *cycle*

<path knot>
 → <tertiary>

<path join>
 → --
 | <direction specifier> <basic path join> <direction specifier>

<direction specifier>
 → <empty>
 | { *curl* <numeric expression> }
 | { <pair expression> }
 | { <numeric expression> , <numeric expression> }

<basic path join>
 → ..
 | ...
 | .. <tension> ..
 | .. <controls> ..

<tension>
 → *tension* <numeric primary>
 | *tension atleast* <numeric primary>
 | *tension* <numeric primary> *and* <numeric primary>

<controls>
 → *controls* <pair primary>
 | *controls* <pair primary> *and* <pair primary>

<argument>
 → <symbolic token>

<number or fraction>
 → <number> / <number>
 | <number> 'not followed by' / <number>

<scalar multiplication op>
 → + | -
 | <number or fraction> 'not followed by' <add op> <number>

<transformer>
 → *rotated* <numeric primary>
 | *scaled* <numeric primary>
 | *shifted* <pair primary>

```

| slanted <numeric primary>
| transformed <transform primary>
| xscaled <numeric primary> | yscaled <numeric primary> | xyscaled <numeric or pair primary>
| zscaled <pair primary>
| reflectedabout \(<pair expression> , <pair expression> )
| rotatedaround \(<pair expression> , <numeric expression> )
| x sized <numeric primary> | y sized <numeric primary> | xysized <numeric or pair primary>
| blownup <numeric or pair primary>
| enlarged <numeric or pair primary>
| xstretched <numeric primary> | ystretched <numeric primary> | stretched <numeric or pair primary>
| shortened <numeric or pair primary>
| enlonged <numeric or pair primary>
| crossed <numeric primary>
| paralleled <numeric primary>
| curved <numeric primary>
| laddered
| leftenlarged <numeric primary> | l lenlarged <numeric primary> | llmoved <numeric primary>
| rightenlarged <numeric primary> | l renlarged <numeric primary> | lrmoved <numeric primary>
| topenlarged <numeric primary> | urenlarged <numeric primary> | urmoved <numeric primary>
| bottomenlarged <numeric primary> | ulenlarged <numeric primary> | ulmoved <numeric primary>
| randomized <numeric or pair or color primary>
| randomizedcontrols <numeric or pair>
| snapped <numeric or pair primary>
| cornered <numeric or pair>
| peepholed <path expression>
| smoothed <numeric or pair>
| squeezed <numeric or pair primary>
| superellipsed <numeric primary>
| randomshifted <numeric or pair primary>
| uncolored <color primary>
| softened <numeric or color primary>
| asgroup <string primary>
| gobbled <primary>
| insideof <path expression>
| outsideof <path expression>
| crossinunder <path expression>

<numeric or pair primary>
→ <numeric primary>
| <pair primary>

<numeric or pair or color primary>
→ <numeric primary>
| <pair primary>
| <color primary>

<numeric or color primary>
→ <numeric primary>
| <color primary>

<nullary op>
→ false | true
| normaldeviate

```

| nullpen | nullpicture | pencircle | whatever

(unary op)

→ (type)
 | ASCII
 | asin | asinh | acos | acosh | atan | cosd | cos | cosh | cot | cotd | sind | sin | sinh | tand | tan
 | inverse | inv | invcos | invsin | invtan
 | sqr | sqrt | pow | exp | mexp | mlog | ln | log | uniformdeviate
 | abs | round | odd | ceiling | floor
 | dir | angle | length | arclength
 | bbox | bbwidth | bbheight
 | bot | lft | rt | top | center
 | colordecimals | decimal | ddecimal | ddecimal | ddddecimal | condition | tostring
 | boundingbox | outerboundingbox | innerboundingbox | bbox
 | colorpart | fontpart | pathpart | penpart | textpart | dashpart
 | redpart | greenpart | bluepart | greypart | graypart
 | cyanpart | magentapart | yellowpart | blackpart
 | postscriptpart | prescriptpart
 | clipped | bounded | stroked | filled | textual
 | punked | paralleled
 | leftboundary | rightboundary | topboundary | bottomboundary
 | xpart | xxpart | xypart | ypart | yxpart | yypart
 | oct | hex
 | colortype
 | grayed | greyed
 | llcorner | lrcorner | ulcorner | urcorner
 | not | known | unknown
 | blackcolor | whitecolor | colormodel
 | char | fontsize
 | cycle | reverse | counterclockwise
 | makepath | makepen
 | unitvector
 | turningnumber
 | circularpath | squarepath | linearpath
 | area | inverted | simplified | unspiked

(type)

→ boolean | numeric | pair | path
 | pen | picture | string | transform
 | color | cmykcolor | greycolor | graycolor | rgbcolor
 | property | transparency
 | outer | inner

(primary binop)

→ * | / | ** | and
 | dotprod | div | infont | mod

(secondary binop)

→ + | - | ++ | +++ | or
 | intersectionpoint | intersectiontimes

(tertiary binop)

→ & | < | <= | <> | = | > | >=
 | cutafter | cutbefore | cutends

| `softjoin`

(of operator)

- `arctime` | `direction` | `directiontime` | `directionpoint` | `penoffset` | `point`
- | `postcontrol` | `precontrol` | `subpath` | `substring`
- | `takepower`

(variable)

- (predefined numeric variable)
- | (predefined path variable)
- | (predefined picture variable)
- | (predefined transform variable)
- | (predefined pair variable)
- | (predefined pen variable)
- | (predefined string variable)
- | (predefined dashpattern)
- | (predefined rgbcolor variable)
- | (predefined macro)
- | (tag) (suffix)

(predefined numeric variable)

- `nothing yet`

(predefined picture variable)

- `blankpicture`
- | `currentpicture`

(predefined transform variable)

- `identity` | `currenttransform`

(predefined path variable)

- `originpath`
- | `fullcircle` | `fullsquare` | `fulldiamond` | `fulltriangle`
- | `unitcircle` | `unitsquare` | `unitdiamond` | `unittriangle`
- | `halfcircle` | `quartercircle`
- | `llcircle` | `lrcircle` | `urcircle` | `ulcircle`
- | `bcircle` | `tcircle` | `lcircle` | `rcircle`
- | `triangle`
- | `righttriangle` | `uptriangle` | `lefttriangle` | `downtriangle`
- | `lltriangle` | `lrtriangle` | `urtriangle` | `ultriangle`
- | `cuttings`

(predefined pair variable)

- `right` | `up` | `left` | `down`
- `shadedright` | `shadedup` | `shadedleft` | `shadeddown`

(predefined pen variable)

- `pensquare` | `penrazor` | `penspec`
- | `currentpen`

(predefined string variable)

- `EOF`
- | `CRLF` | `crlf`
- | `DQUOTE` | `dquote` | `ditto`
- | `SPACE` | `space`

```

| PERCENT | percent
| defaultfont
| extra_beginfig | extra_endfig
| pathconnectors

⟨predefined dashpattern⟩
→ evenly | oddly | withdots

⟨predefined rgbcolor variable⟩
→ red | green | blue | white
| cyan | magenta | yellow | black
| background
| basiccolors

⟨predefined macro⟩
→ shipit | bye
| resetdrawoptions
| visualizepaths | naturalizepaths

⟨suffix⟩
→ ⟨empty⟩
| ⟨suffix⟩ ⟨subscript⟩
| ⟨suffix⟩ ⟨tag⟩
| ⟨suffix parameter⟩

⟨subscript⟩
→ ⟨number⟩
| [ ⟨numeric expression⟩ ]

⟨internal variable⟩
→ aangle | alength
| bboxmargin | labeloffset
| charcode
| defaultcolormodel | defaultpen | defaultscale
| linecap | linejoin | miterlimit
| outputformat | outputtemplate | | prologues
| showstopping pausing
| tracingoutput | tracingcapsules | tracingchoices | tracingcommands | tracingequations
| tracinglostchars | tracingmacros | tracingonline | tracingrestores | tracingspecs
| tracingstats | tracingtitles
| truecorners | warningcheck
| dotlabeldiam
| day | month | year | hour | minute | time
| mm | pt | dd | bp | cm | pc | cc | in
| butt | rounded | squared | mitered | beveled
| pi | radian | eps | epsilon
| nocolormodel | greycolormodel | graycolormodel | rgbcolormodel | cmykcolormodel
| texttextoffset
| maxdimensions
| infinity
| charscale
| metapostversion
| normaltransparent | multiplytransparent | screentransparent | overlaytransparent
| softlighttransparent | hardlighttransparent | colordodgetransparent | colorburntransparent

```

```

| darkenttransparent | lightenttransparent | differencetransparent | exclusiontransparent
| huetransparent | saturationtransparent | colortransparent | luminositytransparent
| <symbolic token defined by newinternal >
| ahandle | ahandlelength
| bboxmargin
| pen_bot | pen_top | pen_lft | pen_rt
| join_radius
| crossingscale | crossingoption

```

<pseudo function>

```

→ min ( <expression list> ) | max ( <expression list> )
| incr ( <numeric variable> ) | decr ( <numeric variable> )
| dashpattern ( <on/off list> )
| interpath ( <numeric expression> , <path expression> , <path expression> )
| interpolated ( <numeric expression> , <path expression> , <path expression> )
| buildcycle ( <path expression list> )
| thelabel <label suffix> ( <expression> , <pair expression> )
| thefreelabel ( <expression> , <pair expression> , <pair expression> )
| anglebetween ( <path expression> , <path expression> , <expression> )
| flex ( <text> )
| hide ( <text> )
| gobble <primary>
| clearit
| clearpen
| clearxy
| pointarrow ( <path expression> , <numeric or pair primary> , <numeric expression> )
| centerarrow ( <path expression> , <numeric or pair primary> , <numeric expression> )
| leftarrow ( <path expression> , <numeric or pair primary> , <numeric expression> )
| rightrightarrow ( <path expression> , <numeric or pair primary> , <numeric expression> )
| paired ( <numeric or pair> ) | tripled ( <numeric or color> )
| remappedcolor ( <color expression> )
| superellipse ( <numeric primary> , <numeric primary> , <numeric primary> , numeric primary ,
  numeric primary )
| roundedsquare ( <numeric primary> , <numeric primary> , <numeric primary> )
| tensecircle ( <numeric primary> , <numeric primary> , <numeric primary> )
| tensepath ( <path primary> )
| (constructed)function ( <string expression> ) ( <string primary> , <string primary> , <numeric primary> ,
  <numeric primary> , <numeric primary> )
| straightfunction ( <string primary> , <string primary> , <numeric primary> , <numeric primary> ,
  <numeric primary> )
| curvedfunction ( <string primary> , <string primary> , <numeric primary> , <numeric primary> ,
  <numeric primary> )
| constructedpairs ( <string expression> ) ( <pair array> )
| straightpairs ( <pair array> )
| curvedpairs ( <pair array> )
| constructedpath ( <string expression> ) ( <text> )
| straightpath ( <text> )
| curvedpath ( <text> )
| epsed <numeric primary>
| arrowhead <path primary>
| arrowpath <path primary>
| infinite <path primary>
| tolist ( <pair array> ) ( <text> )

```

| **topath** (⟨pair array⟩) (⟨text⟩)
 | **tocycle** (⟨pair array⟩) (⟨text⟩)
 | **pencilled** (⟨path expression⟩) (⟨pen expression⟩)

⟨color expression⟩

→ ⟨basic color expression⟩
 | ⟨string primary⟩
 | **namedcolor** (⟨string primary⟩)
 | **spotcolor** (⟨string primary⟩ , ⟨basic color expression⟩)
 | **multitonecolor** (⟨string primary⟩ , ⟨basic color expression list⟩)

⟨basic color expression⟩

→ ⟨rgb color expression⟩
 | ⟨cmyk color expression⟩
 | ⟨gray color expression⟩

⟨basic color expression list⟩

→ ⟨basic color expression⟩
 | ⟨basic color expression list⟩ , ⟨basic color expression⟩

⟨rgb color expression⟩

→ ⟨ () ⟨numeric primary⟩ , ⟨numeric primary⟩ , ⟨numeric primary⟩ ())

⟨cmyk color expression⟩

→ ⟨ () ⟨numeric primary⟩ , ⟨numeric primary⟩ , ⟨numeric primary⟩ , ⟨numeric primary⟩ ())

⟨gray color expression⟩

→ ⟨ () ⟨numeric primary⟩ ())
 | ⟨numeric primary⟩

⟨path expression list⟩

→ ⟨path expression⟩
 | ⟨path expression list⟩ , ⟨path expression⟩

⟨on/off list⟩

→ ⟨on/off list⟩ ⟨on/off clause⟩
 | ⟨on/off clause⟩

⟨on/off clause⟩

→ **on** ⟨numeric tertiary⟩
 | **off** ⟨numeric tertiary⟩

⟨boolean expression⟩ → ⟨expression⟩

⟨cmyk expression⟩ → ⟨expression⟩

⟨color expression⟩ → ⟨expression⟩

⟨numeric atom⟩ → ⟨atom⟩

⟨numeric expression⟩ → ⟨expression⟩

⟨numeric primary⟩ → ⟨primary⟩

⟨numeric tertiary⟩ → ⟨tertiary⟩

⟨numeric variable⟩ → ⟨variable⟩ | ⟨internal variable⟩

⟨pair expression⟩ → ⟨expression⟩

⟨pair primary⟩ → ⟨primary⟩

⟨path expression⟩ → ⟨expression⟩

⟨path subexpression⟩ → ⟨subexpression⟩

⟨pen expression⟩ → ⟨expression⟩

⟨picture expression⟩ → ⟨expression⟩

⟨picture variable⟩ → ⟨variable⟩
 ⟨rgb expression⟩ → ⟨expression⟩
 ⟨string expression⟩ → ⟨expression⟩
 ⟨suffix parameter⟩ → ⟨parameter⟩
 ⟨transform primary⟩ → ⟨primary⟩

⟨program⟩
 → ⟨statement list⟩ end

⟨statement list⟩
 → ⟨empty⟩
 | ⟨statement list⟩ ; ⟨statement⟩

⟨statement⟩
 → ⟨empty⟩
 | ⟨equation⟩
 | ⟨assignment⟩
 | ⟨declaration⟩
 | ⟨macro definition⟩
 | ⟨compound⟩
 | ⟨pseudo procedure⟩
 | ⟨command⟩

⟨compound⟩
 → begingroup ⟨statement list⟩ endgroup
 | beginfig (⟨numeric expression⟩) ; ⟨statement list⟩ (<) endfig
 | **beginglyph** (⟨glyph property list⟩) ; ⟨statement list⟩ (<) endglyph
 | image builder (⟨statement list⟩)

⟨image builder⟩
 → image | **decorated** | **redecorated** | **undecorated**

⟨glyph property list⟩
 → ⟨numeric expression⟩ , ⟨numeric expression⟩ , ⟨numeric expression⟩ , ⟨numeric expression⟩

⟨equation⟩
 → ⟨expression⟩ = ⟨right-hand side⟩

⟨assignment⟩
 → ⟨variable⟩ := ⟨right-hand side⟩
 | ⟨internal variable⟩ := ⟨right-hand side⟩

⟨right-hand side⟩
 → ⟨expression⟩
 | ⟨equation⟩
 | ⟨assignment⟩

⟨declaration⟩
 → ⟨type⟩ ⟨declaration list⟩

⟨declaration list⟩
 → ⟨generic variable⟩
 | ⟨declaration list⟩ , ⟨generic variable⟩

⟨generic variable⟩
 → ⟨Symbolic token⟩ ⟨generic suffix⟩

<generic suffix>
 → <empty>
 | <generic suffix> <tag>
 | <generic suffix> []

<macro definition>
 → <macro heading> = <replacement text> **enddef**

<macro heading>
 → **def** <Symbolic token> <delimited part> <undelimited part>
 | **vardef** <generic variable> <delimited part> <undelimited part>
 | **vardef** <generic variable> **@#** <delimited part> <undelimited part>
 | <binary def> <parameter> <symbolic token> <parameter>

<delimited part>
 → <empty>
 | <delimited part> (<parameter type> <parameter tokens>)

<parameter type>
 → **expr**
 | **suffix**
 | **text**

<parameter tokens>
 → <parameter>
 | <parameter tokens> , <parameter>

<parameter>
 → <Symbolic token>

<undelimited part>
 → <empty>
 | <parameter type> <parameter>
 | <precedence level> <parameter>
 | **expr** <parameter> **of** <parameter>

<precedence level>
 → **primary**
 | **secondary**
 | **tertiary**

<binary def>
 → <primarydef>
 | <secondarydef>
 | <tertiarydef>

<pseudo procedure>
 → **drawoptions** (<option list>)
 | **label** <label suffix> (<expression> , <pair expression>)
 | **thelabel** <label suffix> (<expression> , <pair expression>)
 | **dotlabel** <label suffix> (<expression> , <pair expression>)
 | **makelabel** <makelabel>
 | **labels** <label suffix> (<point number list>)
 | **dotlabels** <label suffix> (<point number list>)
 | **texttext** <label suffix> (<expression>)
 | **infotext** <label suffix> (<expression> , <numeric expression>)

```

| thetext <label suffix> ( <expression> , <pair expression> )
| rawtext ( <expression> )
| verbatim (string expression)
| freelabel ( <expression> , <pair expression> , <pair expression> )
| freedotlabel ( <expression> , <pair expression> , <pair expression> )
| remapcolor ( <color expression> , <color expression> )
| resetcolormap
| recolor <picture expression>
| bitmapimage ( <numeric primary> , <numeric primary> , <string primary> )
| pushboundingbox | popboundingbox
| pushcurrentpicture | popcurrentpicture
| externalfigure (string expression) <transformer>
| loadfigure <string expression> number <numeric expression> <transformer>
| properties
| anchored <label suffix> ( <expression> , <pair expression> )

```

<point number list>

→ <suffix> | <point number list> , <suffix>

<label suffix>

→ <empty>

| **lft** | **rt** | **top** | **bot** | **ulft** | **urt** | **llft** | **lrt** | **raw** | **origin**

<command>

```

→ clip (picture variable) to <path expression>
| interim (internal variable) := <right-hand side>
| let <symbolic token> = <symbolic token>
| pickup <expression>
| randomseed := <numeric expression>
| save <symbolic token list>
| delimiters <character> <character>
| setbounds (picture variable) to <path expression>
| shipout <picture expression>
| special <string expression>
| endinput
| expandafter
| <addto command>
| <drawing command>
| <font metric command>
| <newinternal command>
| <message command>
| <mode command>
| <show command>
| <special command>
| <tracing command>
| <scantokens> <string expression>
| defineshade <symbolic token> <shading expression>
| write <string expression> to <string expression>
| readfrom <string expression>
| readfile <string expression>
| readstring
| restoreclipcolor
| savepen

```

- | `runscript`
- | `relax`

(show command)

- `show` (expression list)
- | `showvariable` (symbolic token list)
- | `showtoken` (symbolic token list)
- | `showdependencies`

(symbolic token list)

- (symbolic token)
- | (symbolic token) , (symbolic token list)

(expression list)

- (expression)
- | (expression list) , (expression)

(addto command)

- `addto` (picture variable) `also` (picture expression) (option list)
- | `addto` (picture variable) `contour` (path expression) (option list)
- | `addto` (picture variable) `doublepath` (path expression) (option list)

(option list)

- (empty)
- | (drawing option) (option list)

(drawing option)

- `withcolor` (color expression) | `withgrey` (numeric expression) | `withgray` (numeric expression)
- | `withrgbcolor` (rgb expression) | `withcmkcolor` (cmyk expression) | `withgreyscale` (numeric expression)
- | `withoutcolor`
- | `withprescript` (string expression) | `withpostscript` (string expression)
- | `withpen` (pen expression)
- | `dashed` (picture expression)
- | `undashed`
- | `withshade` (numeric expression) | `shaded` (shading expression)
- | `withproperties` (property primary)
- | `withtransparency` (pair primary)
- | `withlinearshade` ((path expression) , (path expression) , (color expression) , (color expression))
- | `withcircularshade` ((path ex) , (path ex) , (numeric ex) , (numeric ex) , (color ex) , (color ex))
- | (shading expression)
- | `onlayer` (string expression)
- | `withmask` (string expression)

(property expression)

- (drawing option)

(shading expression)

- `withshademethod` string expression
- | `withshadefactor` numeric expression
- | `withshadedomain` pair expression
- | `withshadevector` pair expression
- | `withshaderadius` pair expression
- | `withshadeorigin` pair expression
- | `withshadecolors` ((color expression) , (color expression))
- | `withshadecenter` pair expression

<drawing command>

→ draw <picture expression> <option list>
| <fi> <path expression> <option list>

<fi>

→ fill | unfill | **refill**
| draw | undraw | **redraw**
| filldraw | **drawfill** | undrawfill | unfilldraw
| **eofill** | **nofill** | **fillup**
| drawdot
| drawarrow | drawdblarrow
| cutdraw
| visualizer
| **normaldraw** | **normalfill**

<visualizer>

→ **drawboundary** | **drawboundingbox** | **drawboundoptions**
| **drawcontrollines** | **drawcontroloptions** | **drawcontrolpoints**
| **drawlabeloptions** | **drawlineoptions** | **drawoptions**
| **draworigin** | **draworiginoptions**
| **drawpath** | **drawpathoptions**
| **drawpoint** | **drawpointlabels** | **drawpointoptions**
| **drawpoints** | **drawwholepath**
| **visualizeddraw** | **visualizedfill**

<newinternal command>

→ newinternal <internal type> <symbolic token list>
| <newinternal> <symbolic token list>

<message command>

→ errhelp <string expression>
| errmessage <string expression>
| filenameemplate <string expression>
| message <string expression>

<mode command>

→ batchmode
| nonstopmode
| scrollmode
| errorstopmode
| interact

<special command>

→ fontmapfile <string expression>
| fontmapline <string expression>
| special <string expression>
| input <string expression>
| prologies <numeric expression>
| outputtemplate <string expression>
| outputformat <string expression>

<tracing command>

→ tracingall
| loggingall

```

| tracingnone

⟨if test⟩
→ if ⟨boolean expression⟩ : ⟨balanced tokens⟩ ⟨alternatives⟩ fi

⟨alternatives⟩
→ ⟨empty⟩
| else : ⟨balanced tokens⟩
| elseif ⟨boolean expression⟩ (:) ⟨balanced tokens⟩ ⟨alternatives⟩
| exit | exitif ⟨boolean expression⟩ | exitunless ⟨boolean expression⟩
| break

⟨loop⟩
→ ⟨loop header⟩ : ⟨loop text⟩ endfor

⟨loop header⟩
→ for ⟨symbolic token⟩ = ⟨progression⟩
| for ⟨symbolic token⟩ = ⟨for list⟩
| for ⟨symbolic token⟩ within ⟨picture expression⟩
| forsuffixes ⟨symbolic token⟩ = ⟨suffix list⟩
| forever

⟨progression⟩
→ ⟨numeric expression⟩ upto ⟨numeric expression⟩
| ⟨numeric expression⟩ downto ⟨numeric expression⟩
| ⟨numeric expression⟩ step ⟨numeric expression⟩ until ⟨numeric expression⟩
| range ⟨numeric expression⟩ thru ⟨numeric expression⟩

⟨for list⟩
→ ⟨expression⟩
| ⟨for list⟩ , ⟨expression⟩

⟨suffix list⟩
→ ⟨suffix⟩
| ⟨suffix list⟩ , ⟨suffix⟩

```

B This document

This document is produced in `CONTEXT` and can serve as an example of how to integrate `METAPOST` graphics into `TEX`. In this appendix we will discuss some details of producing this document.

We did not use any special tricks, so most of the examples you have seen are coded just as shown. We used buffers to ensure that the code used to produce the accompanying graphic is identical to the typeset code in the document. Here is an example.

```
\startbuffer[dummy]
draw fullcircle
  xscaled 3cm yscaled 2cm
  rotatedaround(origin,30)
  withcolor .625red ;
\stopbuffer
```

Instead of using `\getbuffer`, we used the following command:

```
\startlinecorrection[blank]
\processMPbuffer[dummy]
\stoplinecorrection
```

The line correction commands take care of proper spacing around the graphic. If you want to process more buffers at once, you can pass their names as a comma separated list. Alternatively, we could have said:

```
\startuseMPgraphic{dummy}
draw fullcircle
  xscaled 3cm yscaled 2cm
  rotatedaround(origin,30)
  withcolor .625red ;
\stopuseMPgraphic
```

When including this graphic, we again take care of spacing.

```
\startlinecorrection[blank]
\useMPgraphic{dummy}
\stoplinecorrection
```

The first version of this manual was produced with `PDFTEX` and call-outs to `METAPOST`. Because the number of graphics is large, we processed that version using the `--automp` directive (at that moment we were using `TEXEXEC`). And even then runtime was so inconveniently long that updating this manual became less and less fun. The current version is produced with `LUATEX` and `CONTEXT MKIV`, which brings down the runtime (including runtime calls to independent `CONTEXT` runs for the outline examples) to some 45 seconds on a 2.2 Gig Dell M90. Given that (at the time of writing this) over 1700 graphics are generated on the fly, this is not bad at all. On my current machine, a Dell M6700 with an Intel Core i7-3840QM running at 2.8 (3.9) Ghz (and Windows 8) the runtime of the third version was just above 20 seconds all-in and some 25% less when using `LUAJITTEX`. When I started with updating to version 4 of this manual, I timed about 15 seconds on the same machine (but with Windows-10) which means that in the meantime the `CONTEXT/LUATEX` combination gained some 25% performance. Using the new Bash-On-Windows subsystem gives

the same performance. Of course each update adds pages so in the end we need more time with each update but it remains a nice test case. The tight integration of $\text{T}_\text{E}\text{X}$, METAPOST and LUA pays off.

The document style is not that complicated. The main complication in such a document is to make sure that METAPOST is operating under the same font regime, but in MKIV this happens automatically. As document font we use the URW Palatino for the running text combined with Computer Modern Typewriter. Because this document is available as paper and screen document, some large graphics are scaled down in the screen version.

We don't use any special tricks in typesetting this document, but when we added the section about transparency, a dirty trick was needed in a few cases in order to get the described results. Because the screen document has gray backgrounds, exclusive transparencies come out 'wrong'. In the function drawing example we use the following trick to get a black background behind the graphics only. We have a buffer that contains a few lines of code:

```
picture savedpicture ;
savedpicture := currentpicture ;
currentpicture := nullpicture ;
draw savedpicture withcolor black ;
draw savedpicture ;
```

Since we use buffers for the graphics as well, we can now process a buffer with name `example` as follows:

```
\processbuffer[example,wipe]
```

This means that the example code is included two times. After it is processed, we recolor the `currentpicture` black, and after that we add the original picture once again.

C Reference

In this chapter, we will demonstrate most of the drawing related primitives and macros as present in plain METAPOST and METAFUN extensions.

If a path is shown and/or a transformation is applied, we show the original in red and the transformed path or point in yellow. The small dark gray crosshair is the origin and the black rectangle the bounding box. In some drawings, in light gray we show the points that make up the path.

This list describes traditional METAPOST and the stable part of METAFUN. As METAPOST evolves, new primitives are added but they are not always that relevant to us. If you browse the METAFUN sources you will for sure notice more functionality than summarized here. Most of that is meant for usage in CONTEXT and not exposed to the user. Other macros are still somewhat experimental but might become more official at some point. The same is true for METAFUN commands: not all make sense for daily usage and some are just there as helper for additional modules.

C.1 Paths

pair (1,.5)
metapost concept



pair .. pair (0,0)..(.75,0)..(1,.25)..(1,1)
metapost macro

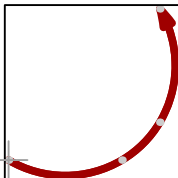

pair ... pair (0,0)..(.75,0)...(1,.25)..(1,1)
metapost macro

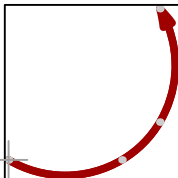

pair -- pair (a) (0,0)--(.75,0)--(1,.25)--(1,1)
metapost macro

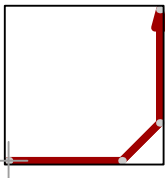

pair -- pair (b) $(0,0)..(.75,0)--(1,.25)..(1,1)$

metapost macro

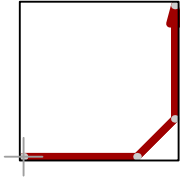
**pair --- pair** $(0,0)..(.75,0)---(1,.25)..(1,1)$

metapost macro

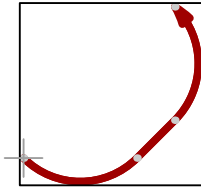
**pair softjoin pair** $(0,0)..(.75,0) \text{ softjoin } (1,.25)..(1,1)$

metapost macro

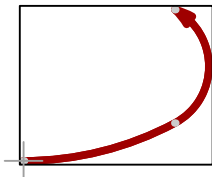
**controls pair** $(0,0)..controls (.75,0)..(1,1)$

metapost primitive

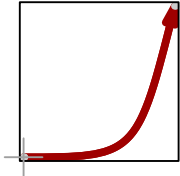
**controls pair and pair** $(0,0)..controls (.75,0) \text{ and } (1,.25)..(1,1)$

metapost primitive

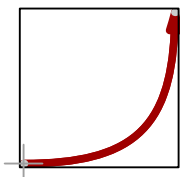
**tension numeric** $(0,0)..(.75,0)..tension 2.5..(1,.25)..(1,1)$

metapost primitive

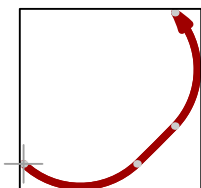

tension num.. and num.. $(0,0)..(.75,0)..tension\ 2.5\ and\ 1.5..(1,.25)..(1,1)$

metapost primitive

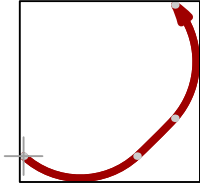
**tension atleast numeric** $(0,0)..(.75,0)..tension\ atleast\ 1..(1,.25)..(1,1)$

metapost primitive

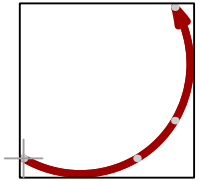
**cycle** $(0,0)--(1,0)--(1,1)--cycle$

metapost primitive

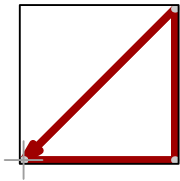
**curl numeric** $(0,0)curl\ 1..(.75,0)..(1,.25)..(1,1)$

metapost primitive

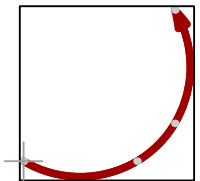
**dir numeric** $(0,0)dir\ 30..(1,1)$

metapost primitive

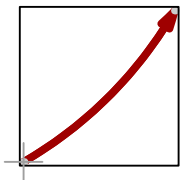
**left** $(0,0)left..(1,1)$

metapost macro

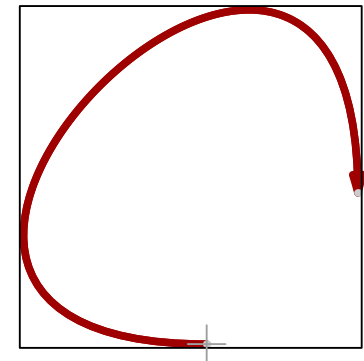

right

```
(0,0)right..(1,1)
```

metapost macro

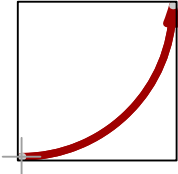

up

```
(0,0)up..(1,1)
```

metapost macro

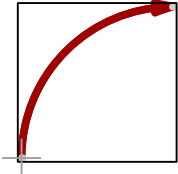

down

```
(0,0)down..(1,1)
```

metapost macro

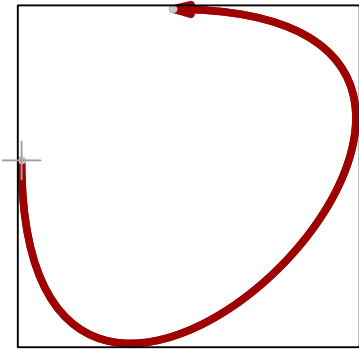

path & path

```
(0,0)..(.75,.25) & (.75,.25)..(1,1)
```

metapost primitive

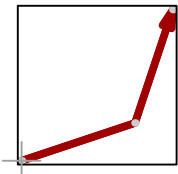

unitvector

```
origin--unitvector(1,1)
```

metapost variable

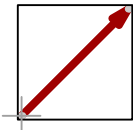

dir

```
origin--dir(45)
```

metapost primitive

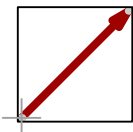

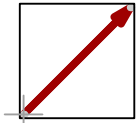
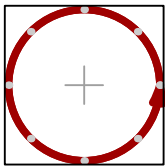
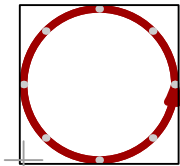
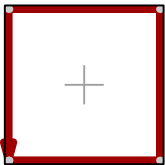
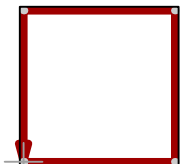
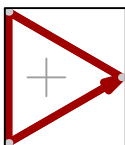
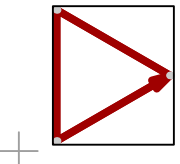
angle`origin--dir(angle(1,1))``metapost primitive`**fullcircle**`fullcircle``metapost variable`**unitcircle**`unitcircle``metafun variable`**fullsquare**`fullsquare``metafun variable`**unitsquare**`unitsquare``metapost variable`**fulltriangle**`fulltriangle``metafun variable`**unittriangle**`unittriangle``metafun variable`

fulldiamond

`fulldiamond`
metafun variable

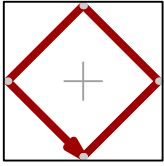

unitdiamond

`unitdiamond`
metafun variable

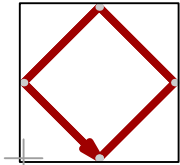

halfcircle

`halfcircle`
metapost variable

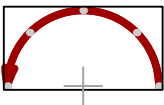

quartercircle

`quartercircle`
metapost variable



llcircle

`llcircle`
metafun variable



lrcircle

`lrcircle`
metafun variable



urcircle

`urcircle`
metafun variable

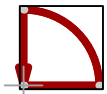

ulcircle

`ulcircle`
metafun variable

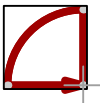

tcircle

`tcircle`
metafun variable

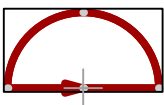

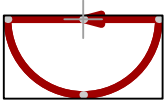
bcircle

`bcircle`
`metafun variable`

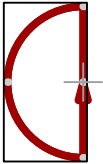
lcircle

`lcircle`
`metafun variable`

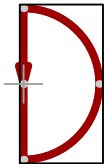
rcircle

`rcircle`
`metafun variable`

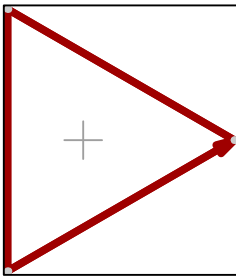
triangle

`triangle`
`metafun variable`

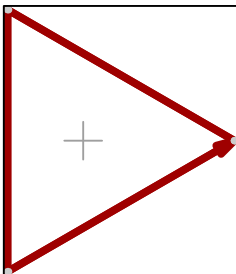
righthtriangle

`righthtriangle`
`metafun variable`

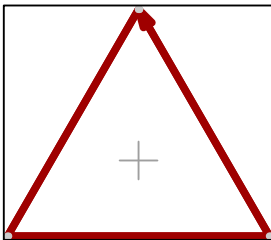
uptriangle

`uptriangle`
`metafun variable`

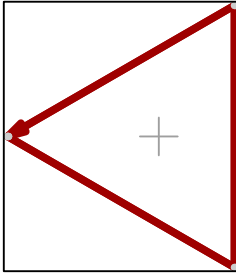
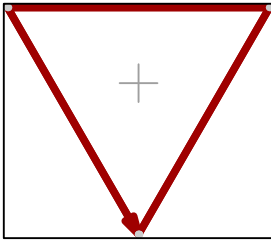
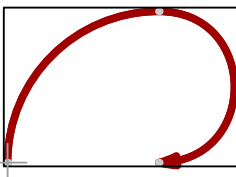
lefttriangle`lefttriangle`
metafun variable**downtriangle**`downtriangle`
metafun variable**lltriangle**`lltriangle`
metafun variable**lrtriangle**`lrtriangle`
metafun variable**urtriangle**`urtriangle`
metafun variable**ultriangle**`ultriangle`
metafun variable**flex(pair,pair,pair)**`flex ((0,0),(1,1),(1,0))`
metapost macro

superellipse(pair,p.,p.,p.,num..)

superellipse((1,.5),(.5,1),(0,.5),(.5,0),.75)

metapost macro

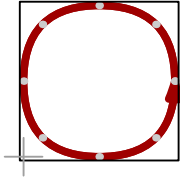
**path smoothed numeric/pair**

unitsquare scaled 1.5 smoothed .2

metafun macro

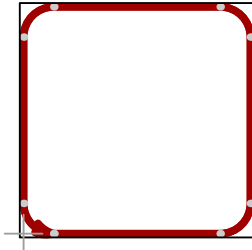
**path cornered numeric/pair**

lltriangle scaled 1.5 cornered .2

metafun macro

**path superellipsed numeric**

unitsquare scaled 1.5 superellipsed .75

metafun macro

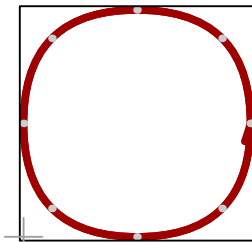
**path randomized numeric/pair**

unitsquare scaled 1.5 randomized (.2,.2)

metafun macro

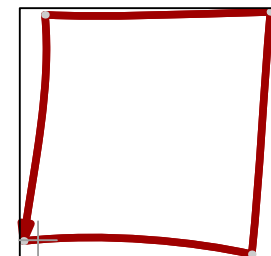

path randomizedcontrols numeric/pair`fullcircle scaled 1.5 randomizedcontrols (.2,.2)`

metafun macro

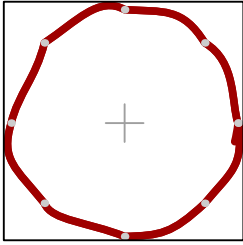
**path squeezed numeric/pair**`unitsquare scaled 1.5 squeezed (.2,.1)`

metafun macro

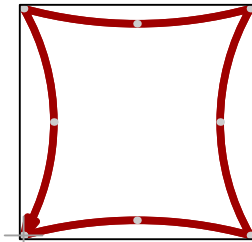
**path snapped numeric/pair**`fullcircle scaled 1.5 snapped (.2,.1)`

metafun macro

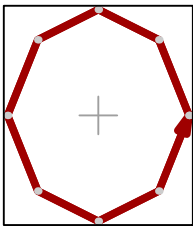
**punked path**`punked unitcircle scaled 1.5`

metafun macro

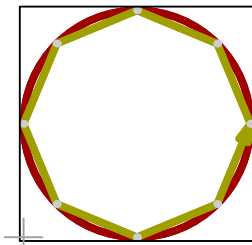
**curved path**`curved ((0,0)--(.2,1)--(1,.2)--cycle)`

metafun macro

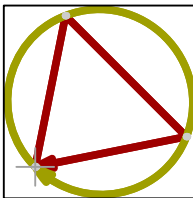

laddered path

```
laddered ((0,0)--(1.4,.8)--(2.8,1.2)--(6.2,1.6))
```

metafun macro

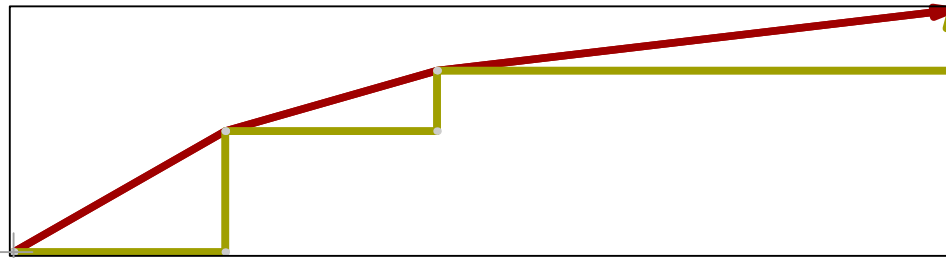

path paralleled distance

```
((0,0)--(5,1)) paralleled .25
```

metafun macro

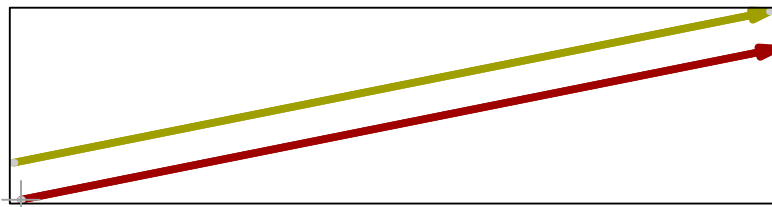

shortened path

```
((0,0)--(6,1)) shortened 1
```

metafun macro

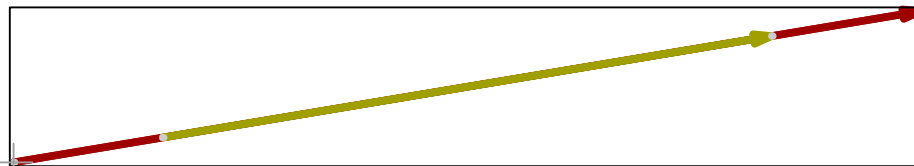

unspiked path

```
unspiked ((0,0)--(1,0)--(1,1)--(2,1)--(1,1)--(0,1))
```

metafun macro

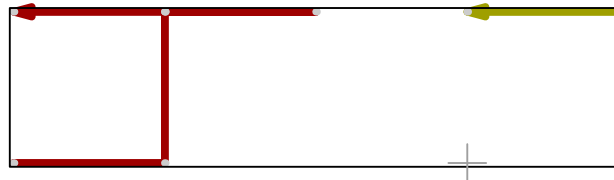

simplified path

```
simplified ((0,0)--(1,0)--(2,0)--(2,1)--(0,1)--cycle)
```

metafun macro

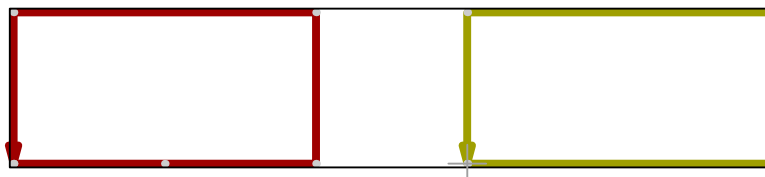

path blowup numeric/pair

```
(fullcircle scaled 1.5) blowup .1
```

metafun macro

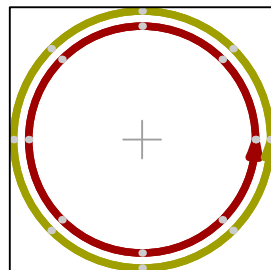

path stretched numeric/pair (a)

`(fullcircle scaled 1.5) stretched (1.1,0.8)`

metafun macro

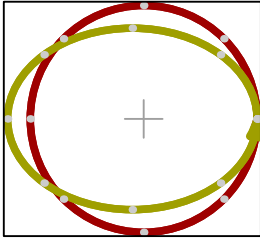

path stretched numeric (b)

`((0,0)--(1,1)) stretched 1.5`

metafun macro

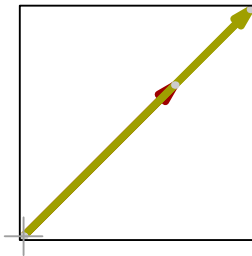

path xstretched numeric

`fullcircle xstretched 5`

metafun macro

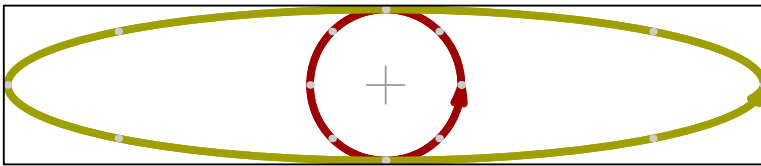

path ystretched numeric

`fullcircle ystretched 1.5`

metafun macro

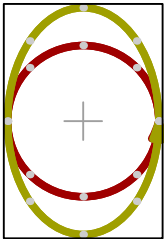

path enlonged numeric

`((0,0)--(1,1)) enlonged 1.5`

metafun macro

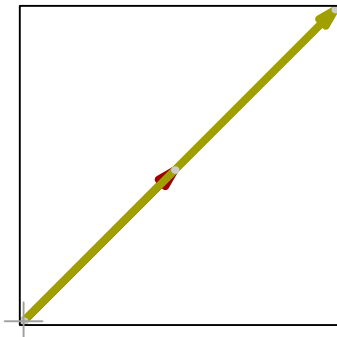

path shorted numeric`((0,0)--(2,2)) shortened 0.5`

metafun macro

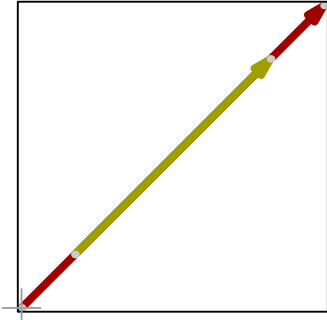
**roundedsquare(num.,num.,num.)**`roundedsquare(2,1,.2)`

metafun macro

**tensecircle(num.,num.,num.)**`tensecircle(2,1,.2)`

metafun macro

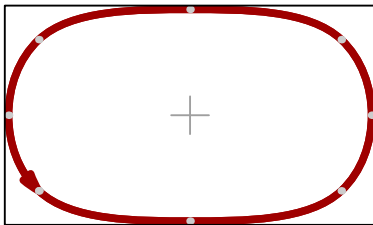
**pair crossed size**`origin crossed 1`

metafun macro

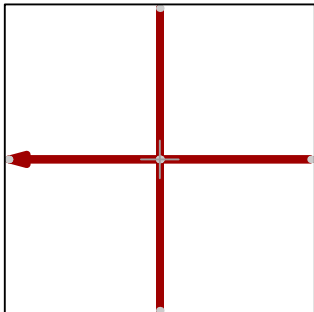

path crossed size

```
fullcircle scaled 2 crossed .5
```

metafun macro

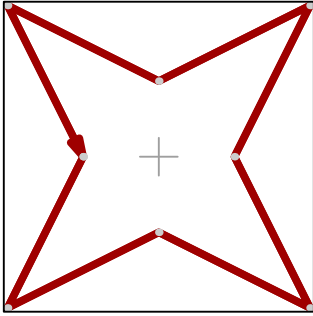

(constructed)function

```
constructedfunction("--")("x","sin(x)",0,2pi,pi/10)
```

metafun macro

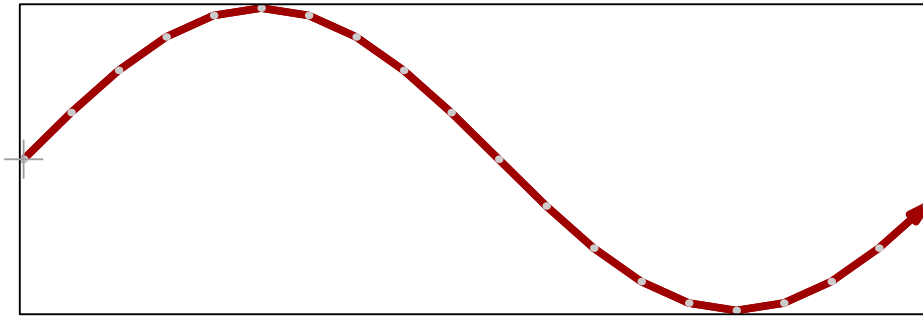

curvedfunction

```
curvedfunction("x","sin(x)",0,2pi,pi/10)
```

metafun macro

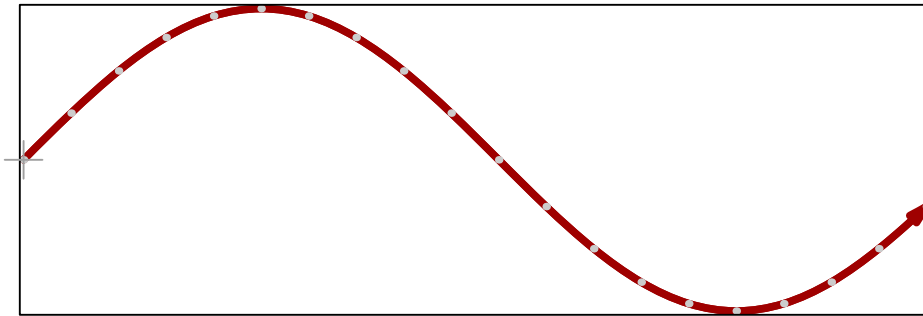

straightfunction

```
straightfunction("x","sin(x)",0,2pi,pi/10)
```

metafun macro

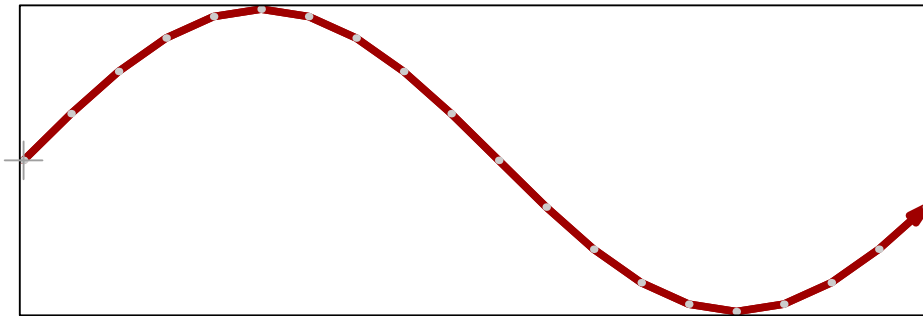

constructedpath`constructedpath("..")((0,0),(1,2),(2,1),(3,2))`

metafun macro

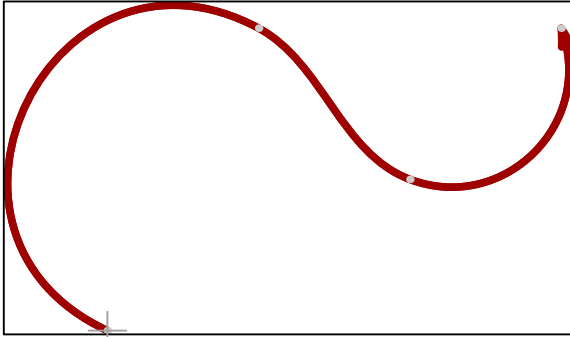
**curvedpath**`curvedpath((0,0),(1,2),(2,1),(3,2))`

metafun macro

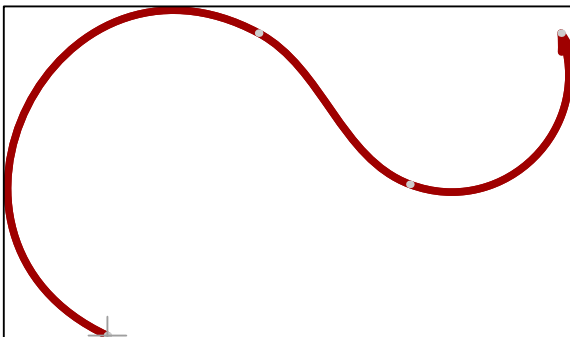
**straightpath**`straightpath((0,0),(1,2),(2,1),(3,2))`

metafun macro

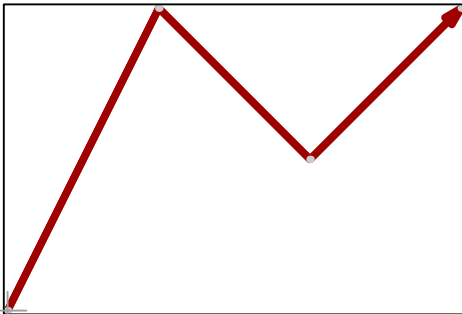
**leftarrow**`leftarrow(fullcircle,3,2)`

metafun macro

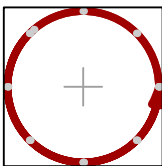
**rightarrow**`rightarrow(fullcircle,3,2)`

metafun macro

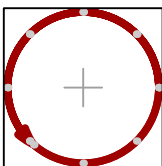

centerarrow

```
centerarrow(fullcircle,3,2)
```

metafun macro

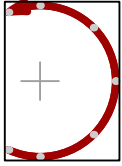

arrowhead

```
draw arrowhead fullcircle
```

metafun macro



arrowpath

```
draw arrowpath fullcircle
```

metafun macro

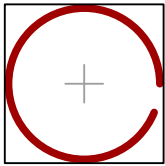

buildcycle

```
buildcycle(fullcircle,fullsquare)
```

metapost macro

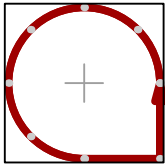

circularpath

```
circularpath(4)
```

metafun macro

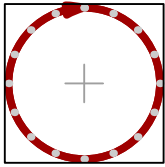

squarepath

```
squarepath(4)
```

metafun macro

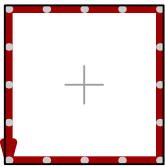

linearpath

```
linearpath(4)
```

metafun macro



C.2 Transformations

path scaled numeric

fullcircle scaled .50
metapost primitive

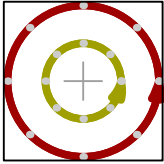

path xscaled numeric

fullcircle xscaled .25
metapost primitive

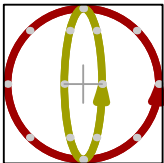

path yscaled numeric

fullcircle yscaled .25
metapost primitive

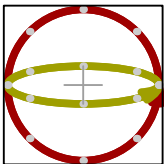

path zscaled pair

fullcircle zscaled (2,.25)
metapost primitive

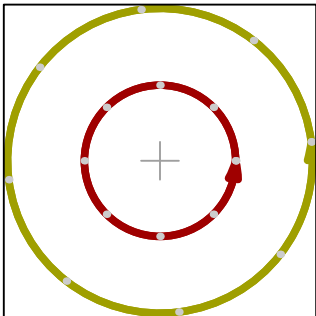

path xyscaled numeric/pair

fullcircle xyscaled (.5,.7)
metapost primitive

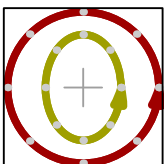

path yscaled pair

fullcircle yscaled (2,.25)
metapost primitive

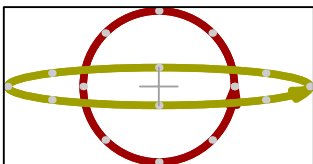

path shifted pair

`fullcircle shifted (2,.25)`
`metapost primitive`

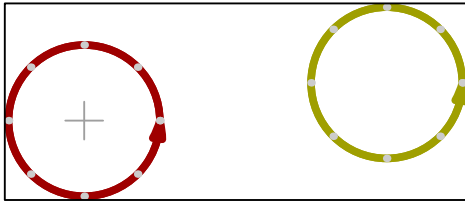

path leftenlarged numeric

`fullsquare leftenlarged .25`
`metafun macro`

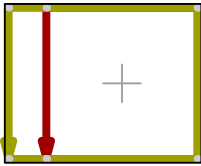

path topenlarged numeric

`fullsquare topenlarged .25`
`metafun macro`

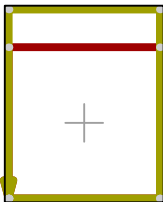

path rightenlarged numeric

`fullsquare rightenlarged .25`
`metafun macro`

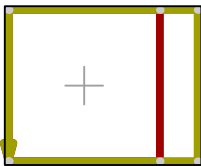

path bottomenlarged numeric

`fullsquare bottomenlarged .25`
`metafun macro`

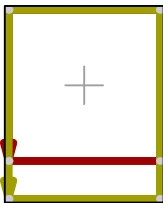

path enlarged numeric

`fullcircle enlarged .25`
`metafun macro`

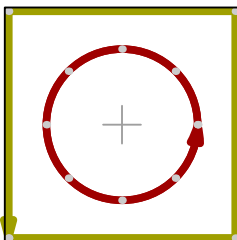

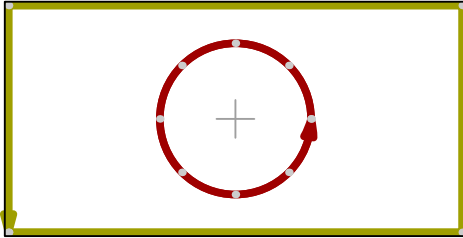
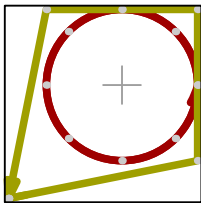
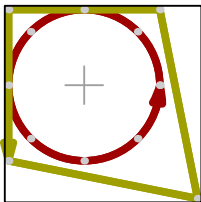
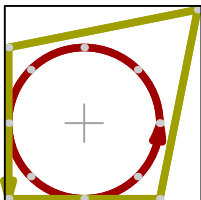
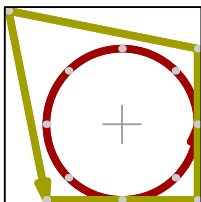
path enlarged pair`fullcircle enlarged (1,.25)``metafun macro`**path llenlarged numeric**`fullcircle llenlarged .25``metafun macro`**path lrenlarged numeric**`fullcircle lrenlarged .25``metafun macro`**path urenlarged numeric**`fullcircle urenlarged .25``metafun macro`**path ulenlarged numeric**`fullcircle ulenlarged .25``metafun macro`

path llenlarged pair

`fullcircle llenlarged (1,.25)`
metafun macro

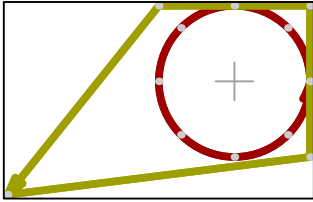

path lrenlarged pair

`fullcircle lrenlarged (1,.25)`
metafun macro

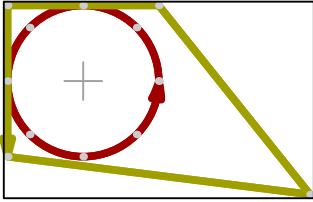

path urenlarged pair

`fullcircle urenlarged (1,.25)`
metafun macro

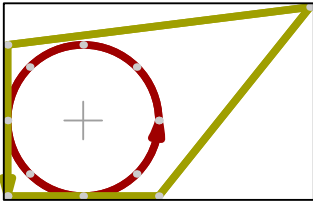

path ulenlarged pair

`fullcircle ulenlarged (1,.25)`
metafun macro

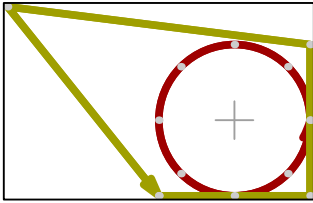

path llmoved numeric

`fullcircle llmoved .25`
metafun macro

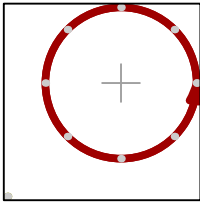

path lrmoved numeric

`fullcircle lrmoved .25`
metafun macro

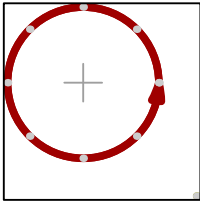

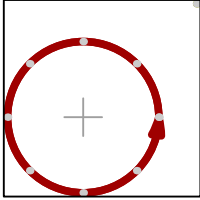
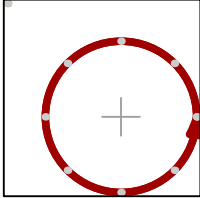
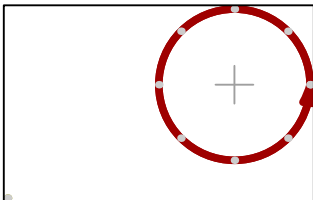
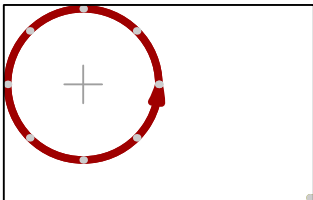
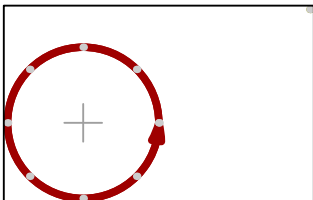
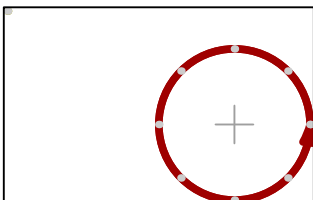
path urmoved numeric`fullcircle urmoved .25``metafun macro`**path ulmoved numeric**`fullcircle ulmoved .25``metafun macro`**path llmoved pair**`fullcircle llmoved (1,.25)``metafun macro`**path lrmoved pair**`fullcircle lrmoved (1,.25)``metafun macro`**path urmoved pair**`fullcircle urmoved (1,.25)``metafun macro`**path ulmoved pair**`fullcircle ulmoved (1,.25)``metafun macro`

path slanted numeric

`fullcircle slanted .5`
 metapost primitive

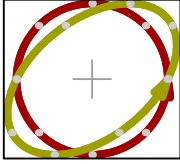
**path rotated numeric**

`fullsquare rotated 45`
 metapost primitive

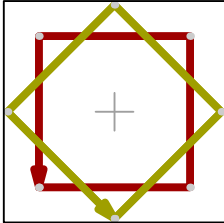
**path rotatedaround(pair,numeric)**

`fullsquare rotatedaround((.25,.5),45)`
 metapost macro

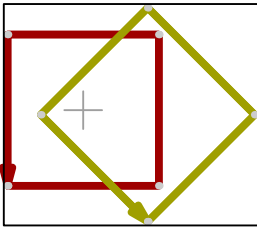
**path reflectedabout(pair,pair)**

`fullcircle reflectedabout((.25,-1),(0.25,+1))`
 metapost macro

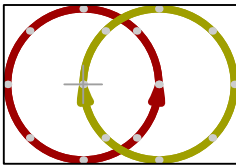
**reverse path**

`reverse fullcircle shifted(.5,0)`
 metapost primitive

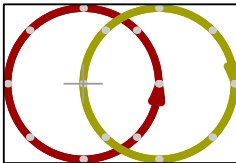
**counterclockwise path**

`counterclockwise fullcircle shifted(.5,0)`
 metapost macro

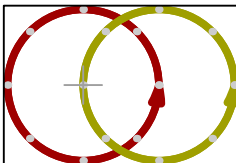

tensepath path

tensepath fullcircle

metapost macro

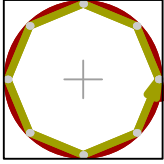
**subpath (numeric,numeric) of path**

subpath (1,5) of fullcircle

metapost primitive

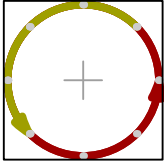
**path cutbefore pair**

fullcircle cutbefore point 3 of fullcircle

metapost macro

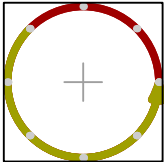
**path cutafter pair**

fullcircle cutafter point 3 of fullcircle

metapost macro

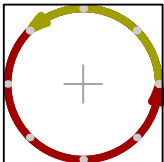
**path cutends .1**

fullcircle cutends .5

metapost macro

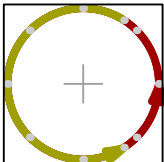
**llcorner path**

llcorner fullcircle

metapost primitive

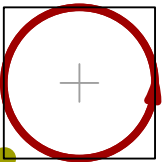
**lrcorner path**

lrcorner fullcircle

metapost primitive

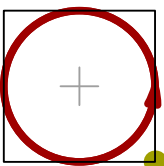

urcorner path

`urcorner fullcircle`
`metapost primitive`

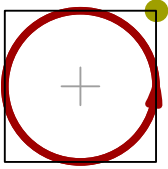
**ulcorner path**

`ulcorner fullcircle`
`metapost primitive`

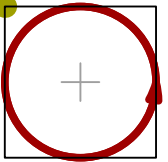
**center path**

`center fullcircle`
`metapost macro`

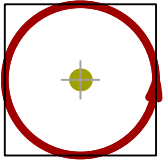
**boundingbox path**

`boundingbox fullcircle`
`metafun macro`

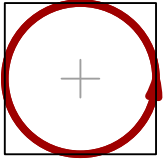
**boundingcircle path**

`boundingcircle fullsquare`
`metafun macro`

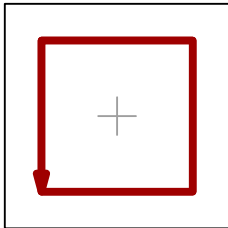
**innerboundingbox path**

`innerboundingbox fullcircle`
`metafun macro`

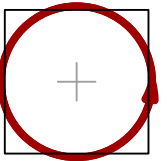

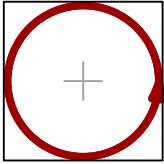
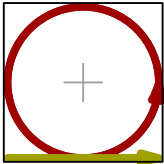
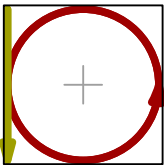
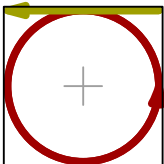
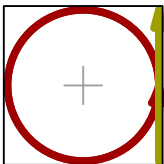
outerboundingbox path`outerboundingbox fullcircle``metafun macro`**bottomboundary path**`bottomboundary fullcircle``metafun macro`**leftboundary path**`leftboundary fullcircle``metafun macro`**topboundary path**`topboundary fullcircle``metafun macro`**rightboundary path**`rightboundary fullcircle``metafun macro`**bbwidth path**`draw texttext(decimal bbwidth (fullcircle xscaled 100 yscaled 200))``metafun macro`**bbwidth path**`draw texttext(decimal bbheight (fullcircle xscaled 100 yscaled 200))``metafun macro`

path/picture x sized numeric

```
currentpicture x sized 5cm
metafun macro
```

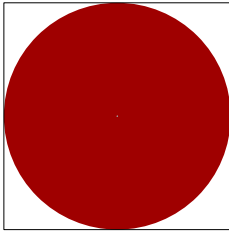

path/picture y sized numeric

```
currentpicture y sized 2cm
metafun macro
```

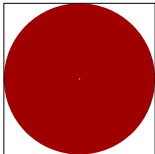

path/picture x y sized numeric

```
currentpicture x y sized (3cm,2cm)
metafun macro
```

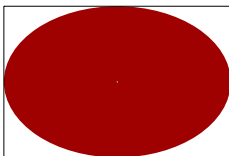

area path

```
draw area ((0,10)--(20,20)--(30,5)--(40,10)--(50,5)--(60,5))
metafun macro
```

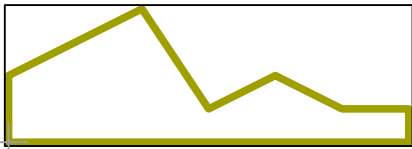

setbounds picture

```
draw fullcircle ; setbounds currentpicture to unitsquare
metapost primitive
```

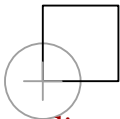

clip path

```
fill fullcircle ; clip currentpicture to fullsquare scaled 0.9
metapost macro
```

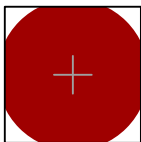

path peepholed path

```
fill (fullcircle peepholed fullsquare)
metapost macro
```

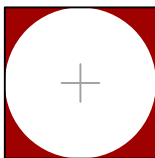

anchored`draw anchored.urt(texttext("ll"),origin)`

metafun macro

**path crossingunder path**`draw (fullsquare rotated 45) crossingunder fullsquare`

metafun macro

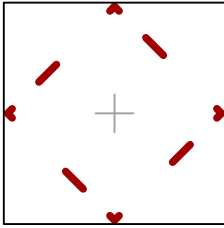

C.3 Points

top pair`top center fullcircle`

metapost macro

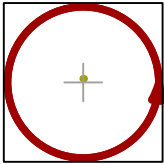
**bot pair**`bot center fullcircle`

metapost macro

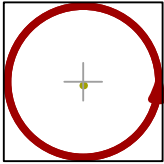
**lft pair**`lft center fullcircle`

metapost macro

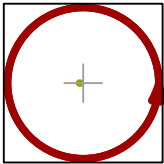
**rt pair**`rt center fullcircle`

metapost macro

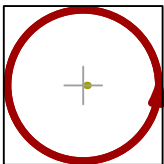

point numeric of path

point 2 of fullcircle
metapost primitive

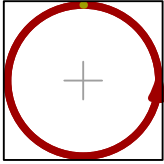

point numeric on path

point .5 on fullcircle
metafun macro

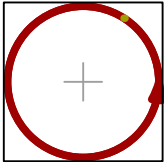

point numeric along path

point 1cm along fullcircle
metafun macro

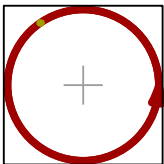

precontrol numeric of path

precontrol 2 of fullcircle
metapost primitive

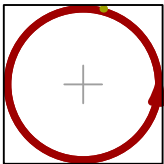

postcontrol numeric of path

postcontrol 2 of fullcircle
metapost primitive

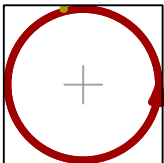

directionpoint pair of path

directionpoint (2,3) of fullcircle
metapost primitive

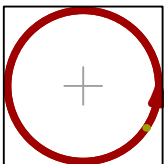

numeric[pair,pair]

.5[(0,0),(1,1)]
metapost concept

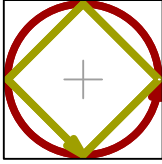
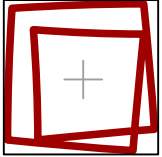
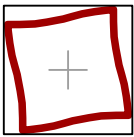

path intersectionpoint path`fullcircle intersectionpoint fulldiamond``metapost macro`**interpath(numeric,path,path)**`interpath(.8,fullcircle,fullsquare)``metapost macro`**interpolated(numeric,path,path)**`interpolated(.8,fullcircle,fullsquare)``metafun macro`**right**`draw left``metapost macro`**up**`draw up``metapost macro`**left**`draw left``metapost macro`**down**`draw down``metapost macro`

C.4 Colors

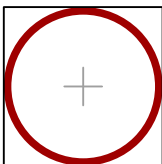
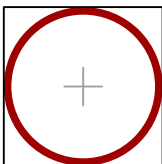
withcolor rgbcolor`withcolor (.625,0,0)``metapost primitive`**withrgbcolor rgbcolor**`withrgbcolor (.625,0,0)``metapost primitive`

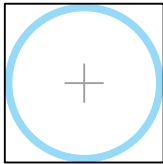
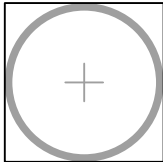
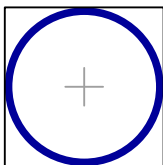
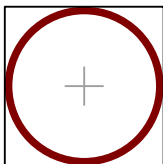
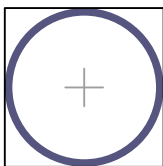
withcmykcolor cmykcolor`withcmykcolor (.375,0,0,0)``metapost primitive`**withgray / withgrey numeric**`withgray .625``metapost primitive`**withcolor namedcolor**`withcolor namedcolor("darkblue")``metapost primitive`**withcolor spotcolor**`withcolor spotcolor("temptone",red/2)``metapost primitive`**withcolor multitonecolor**`withcolor .2 * multitonecolor("temptwo",blue/2,yellow/3)``metapost primitive`

Remark: at the time of this writing only Acrobat shows spot- and multitonecolors properly. Possible indications of a viewing problem are factors not being applied (in the page stream) or colors that are way off.

red`fill fullcircle scaled 2 withcolor red/2``metapost primitive`**green**`fill fullcircle scaled 2 withcolor green/2``metapost primitive`

blue `fill fullcircle scaled 2 withcolor blue/2`
 metapost primitive



cyan `fill fullcircle scaled 2 withcolor cyan/2`
 metapost primitive



magenta `fill fullcircle scaled 2 withcolor magenta/2`
 metapost primitive



yellow `fill fullcircle scaled 2 withcolor yellow/2`
 metapost primitive



black `fill fullcircle scaled 2 withcolor black/2`
 metapost primitive



white `fill fullcircle scaled 2 withcolor white/2`
 metapost primitive



blackcolor `fill fullcircle withcolor blackcolor red`
 metapost primitive



withtransparency(num,num) `withcolor red withtransparency (1,.625)`
 metafun macro

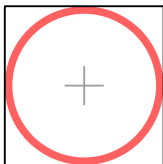

shaded someshade `fill fullsquare shaded lshade`
 metafun macro

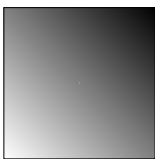

This assumes the definition:

```
defineshade lshade withshademethod "linear" ;
```

shaded someshade

```
fill fullcircle shaded cshade
metafun macro
```

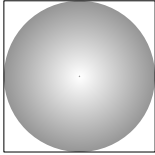

This assumes the definition:

```
defineshade cshade withshademethod "circular" ;
```

basiccolors

```
for i=0 upto 21 : fill ... withcolor basiccolors[i] ; endfor
metapost primitive
```



C.5 Attributes

dashed withdots

```
dashed withdots
metapost primitive
```

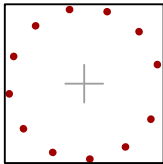

dashed evenly

```
dashed evenly
metapost primitive
```

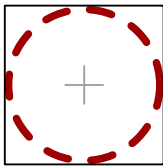

dashed oddly

```
dashed oddly
metapost primitive
```

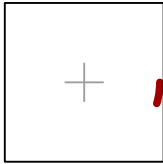

dashpattern

```
dashed dashpattern (on .1 off .2 on .3 off .4)
metapost primitive
```

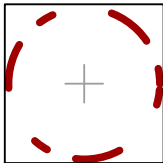

undashed

dashed evenly undashed

metapost primitive

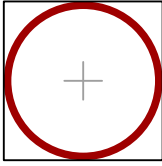
**withpen pencircle transform**

withpen pencircle scaled 2mm

metapost macro

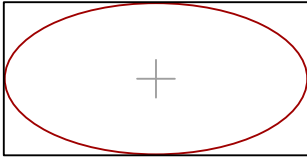
**withpen pensquare transform**

withpen pensquare scaled 2mm

metapost macro

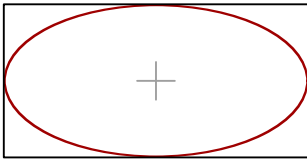
**withpen penrazor transform**

withpen penrazor scaled 2mm

metapost macro

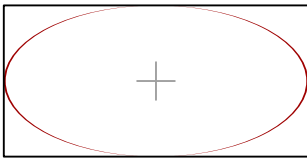
**withpen penspeck transform**

withpen penspeck

metapost macro

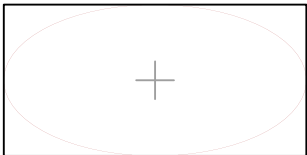
**draw**

draw fullcircle

metapost macro

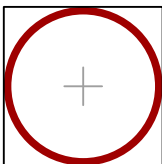
**fill**

fill fullcircle

metapost macro

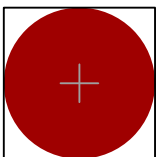

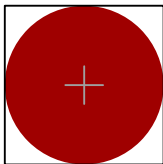
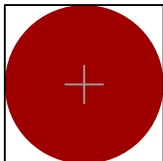
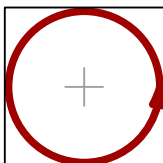
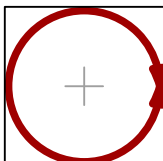
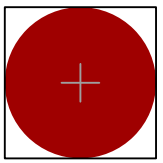
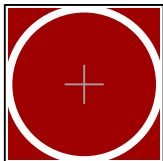
filldraw`filldraw fullcircle``metapost macro`**drawfill**`drawfill fullcircle``metapost macro`**drawdot**`drawdot origin``metapost macro`**drawarrow**`drawarrow fullcircle``metapost macro`**drawdblarrow**`drawdblarrow fullcircle``metapost macro`**eofill**`eofill fullcircle``metafun macro`**undraw**`undraw fullcircle``metapost macro`

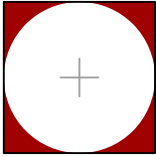
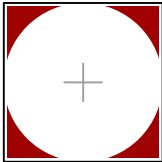
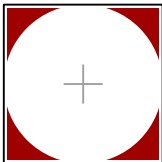
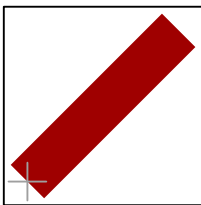
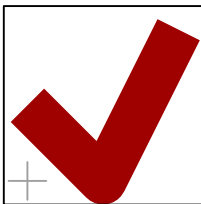
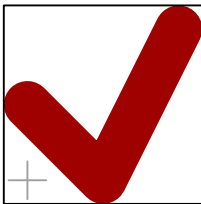
unfill`unfill fullcircle``metapost macro`**unfilldraw**`unfilldraw fullcircle``metapost macro`**undrawfill**`undrawfill fullcircle``metapost macro`**undrawdot**`undrawdot origin``metapost macro`**cutdraw**`origin--(1,1)``metapost macro`**butt**`linecap := butt``metapost variable`**rounded**`linecap := rounded``metapost variable`

squared

`linecap := squared`
 metapost variable

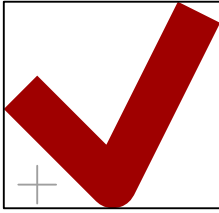
**mitered**

`linejoin := mitered`
 metapost variable

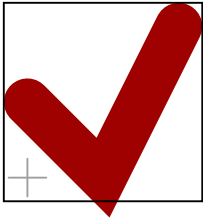
**rounded**

`linejoin := rounded`
 metapost variable

**beveled**

`linejoin := beveled`
 metapost variable

**inverted picture**

`inverted currentpicture`
 metafun macro

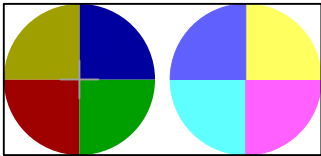
**picture uncolored color**

`currentpicture uncolored green`
 metafun macro

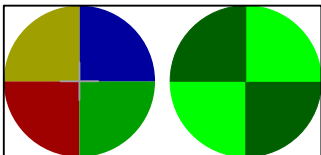

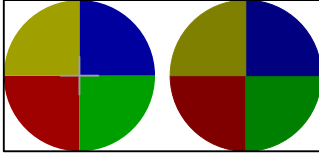
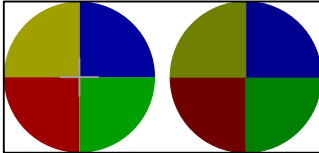
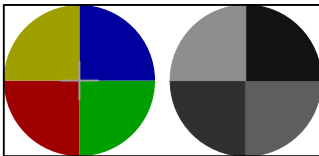
picture softened numeric`currentpicture softened .8``metafun macro`**picture softened color**`currentpicture softened (.7,.8,.9)``metafun macro`**grayed picture**`grayed currentpicture``metafun macro`**C.6 Text****label**`label("MetaFun",origin)``metapost macro`**label.top**`label.top("MetaFun",origin)``metapost macro`**label.bot**`label.bot("MetaFun",origin)``metapost macro`**label.lft**`label.lft("MetaFun",origin)``metapost macro`**label.rt**`label.rt("MetaFun",origin)``metapost macro`**label.llft**`label.llft("MetaFun",origin)``metapost macro`

label.lrt`label.lrt("MetaFun",origin)`

metapost macro

label.urt`label.urt("MetaFun",origin)`

metapost macro

label.ulft`label.ulft("MetaFun",origin)`

metapost macro

dotlabel`dotlabel.bot("metafun", (2cm,1cm))`

metapost primitive

dotlabels + range .. thru ..`z1 = ... ; dotlabels.bot(range 1 thru 3)`

metapost primitive

labels + range .. thru ..`z1 = ... ; labels.bot(range 1 thru 3)`

metapost primitive

thelabel(string,pair)`draw thelabel("MetaFun", (2cm,0))`

metafun macro

formatted(string)`draw texttext(formatted("@0.5f",1.234))`

metafun macro

format(string) : graph package`draw texttext(format("@5E-2",1.234))`

metafun macro

btex text etex`draw btex MetaTeX etex`

metapost primitive

texttext(string) draw texttext("MetaFun")
metafun macro

MetaFun

thetexttext(string, pair) draw thetexttext("MetaFun", (2cm,0))
metafun macro

+

MetaFun

outlinetext.d("string")(d) draw outlinetext.d("MetaFun") (InRed)
metafun macro

MetaFun

outlinetext.f("string")(f) draw outlinetext.f("MetaFun") (InYellow)
metafun macro

MetaFun

outlinetext.b("string")(f)(d) draw outlinetext.b("MetaFun") (InYellow) (InRed)
metafun macro

MetaFun

outlinetext.r("string")(d)(f) draw outlinetext.r("MetaFun") (InRed) (InYellow)
metafun macro

MetaFun

outlinetext.p("string") draw outlinetext.p("MetaFun")
metafun macro

MetaFun

C.7 Control

for (positive step) until for i=0 step 2 until 8: drawdot (i,0) ; endfor
metapost primitive

for (negative step) until for i=6 step -2 until 0: drawdot (i,0) ; endfor
metapost primitive

for upto for i=0 upto 12: drawdot (i,0) ; endfor
metapost macro

for downto for i=10 downto 0: drawdot (i,0) ; endfor
metapost macro

forsuffixes forsuffixes i=1,4,6,12: drawdot (i,0) ; endfor
metapost macro

C.8 Graphics

loadfigure string number numeric ...

```
loadfigure "mycow.mp" number 1 scaled .25
```

metafun macro

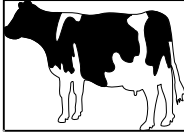

externalfigure string ...

```
draw externalfigure "mycow.pdf" scaled 3cm
```

metafun macro

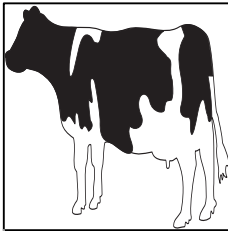

addbackground text

```
addbackground withcolor .625 yellow
```

metafun macro

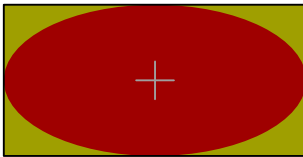
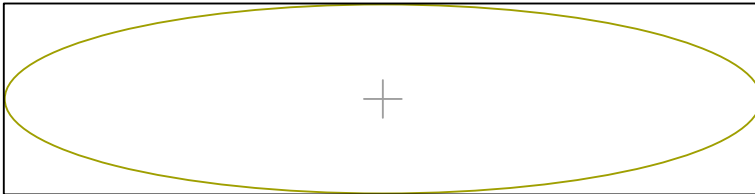

image (text)

```
draw image(draw fullcircle) xscaled 4cm yscaled 1cm
```

metapost macro



decorated (text) text

```
draw decorated (...) withcolor red
```

metapost macro

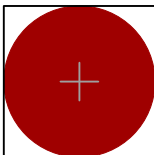

undecorated (text) text

```
draw undecorated (... withcolor yellow) withcolor red
```

metapost macro

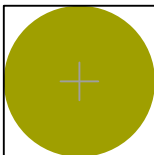

redecorated (text) text

```
draw redecorated (... withcolor yellow) withcolor red
metapost macro
```

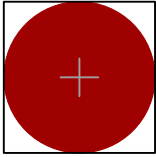
**bitmapimage (w,h,data)**

```
draw bitmapimage (2,2,"114477AA") rotated 15 scaled 4cm
metapost macro
```

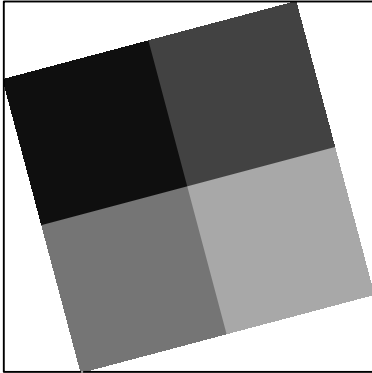
**withmask string**

```
draw externalfigure "m-1.png" scaled 2cm withmask "m-2.png"
metapost macro
```



Index

- a**
 anchoring 151, 156
 angles 22, 297
 arguments 32
 attributes 37, 410
 axis 234
- b**
 backgrounds 171, 175
 bleeding 182
 boundingbox 64
 buffers 123
- c**
 clipping 47, 210
 color 37, 124, 302
 manipulating 217
 colors 407
 conditions 28
 crossing paths 115
 curl 79
 curves 73
 cutting 57
- d**
 dashes 39
 debugging 273
 definitions 30
 directions 97
 drawing 23
- e**
 environments 245
 equations 40
 expressions 40
- f**
 filling 103
 functions 233
- g**
 graphics 63, 418
 buffers 123
 embedded 118
 external 117
 including 215
 libraries 190, 266
 positioning 151
 standalone 122
 symbols 191
 variables 189
 grids 234
- i**
 inflection 79
 interfacing 185
 interims 109
 internals 109
- j**
 joining 37
- l**
 LUA 345
 labels 246, 292
 language 363
 layers 156, 158
 layout 167, 281
 loops 28, 417
- m**
 macros 30
 arguments 32
 metafun 343
- o**
 outlines 221
 overlays 135, 171
 stack 174
- p**
 paths 7, 14, 379
 cutting 57
 joining 37
 pens 33
 pictures 60
 analyzing 98
 points 405
 positioning 151
 processing 5, 117

r

randomization 186
reversing 103
rotation 22
running 5, 117

s

scaling 71
segmented paths 114
shading 200
shifting 71
styles 281
symbols 191
syntax 363

t

tension 79
text 39, 164, 245, 247, 415
 outlines 221
transformations 10, 88, 395
transparency 195

u

units 69

v

variables 26, 189

This document introduces you in the world of the graphic programming language MetaPost. Not only the language itself is covered in detail, but also the way to interface with the typographic language \TeX . We also present the collection of MetaPost extensions that come with the \ConTeXt typesetting system. This collection goes under the name MetaFun.

All aspects of the MetaPost language are covered. The first chapters focus on the language itself, later chapters cover aspects like color, graphic inclusions, adding labels, and stepwise constructing graphics. We finish with a graphical overview of commands.

PRAGMA Advanced Document Engineering, Hasselt NL, 2017